

2018  
2019



# MEASURING INSTRUMENTS

CATALOG NO. 302



# QUALITY | INNOVATION | SERVICE | VALUE



The products with this mark are INSIZE PLUS brand

←INSIZE→ is our standard quality and made in Asia – Korea, China, Taiwan, etc.

←INSIZE PLUS→ is our premium quality and mainly made in Germany, UK and Italy



The products with this mark are supplied with manufacturer inspection certificate. Some of them are traceable to NIST.



INSIZE		Inspection Certificate	
Product name	Digital Caliper	Traceable to	USA NIST No.821/279484-10
Code No.	1108-150		Germany DKD No.D-K-18198-01-00
Measuring range	0-150mm / 0-6"	Inspector	<i>David</i>
Resolution	0.01mm / 0.0005"	Judgement	Passed
Serial No.	0910120004		
Standard temperature	20°C / 68°F		

Measuring Length	Permissible Error	Error		Measuring Length	Permissible Error	Error	
		External	Internal			External	Internal
0.4 DIA	+0.0005 -0.0010	/	0.0005	Φ10	+0.01 -0.02	/	0.01
2	±0.0010	-0.0005	/	50	±0.02	-0.01	/
4		-0.0005	/	100		-0.01	/
6		-0.0010	/	150		-0.02	/
8		/	/	200		/	/
10	±0.0015	/	/	250	±0.03	/	/
12		/	/	300		/	/



Please scan QR code to watch the basic operation video of the products.

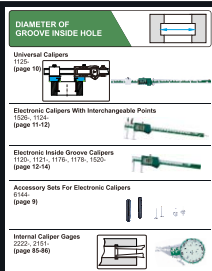

Application index (page 218-222)

We reserve the right to change or modify the design and specification of products in this catalogue without prior notice.



# PRODUCT INDEX

1

DATA OUTPUT AND SOFTWARE PAGE 1-3



MEASURING DATA MANAGEMENT SOFTWARE  
DATA OUTPUT CABLE

2

CALIPER PAGE 3-21



DIGITAL CALIPER  
DIAL CALIPER  
VERNIER CALIPER

3

DEPTH GAGE PAGE 21-27



DEPTH GAGE  
DIAL DEPTH GAGE  
DEPTH MICROMETER

4

HEIGHT GAGE PAGE 28-30



DIGITAL HEIGHT GAGE  
VERNIER HEIGHT GAGE

5

MICROMETER PAGE 31-49



DIGITAL OUTSIDE MICROMETER  
OUTSIDE MICROMETER  
MICROMETER HEAD

6

BORE AND SHAFT DIAMETER PAGE 50-63



PISTOL GRIP THREE POINTS BORE GAGE  
THREE POINTS INTERNAL MICROMETER  
INSIDE MICROMETER  
TUBULAR INSIDE MICROMETER  
BORE PLUG GAGE  
BORE GAGE  
SETTING RING  
INTERNAL CHAMFER GAGE  
TELESCOPING GAGE SET  
DIGITAL RADIUS GAGE

7

INDICATOR PAGE 64-85



DIGITAL INDICATOR  
DIAL INDICATOR  
DIAL TEST INDICATOR  
MAGNETIC STAND  
DIAL INDICATOR STAND  
BENCH CENTER

8

PAGE 85-92



INTERNAL/EXTERNAL CALIPER GAGE  
DIGITAL THICKNESS GAGE  
DIAL SNAP GAGE  
DIGITAL SNAP GAGE

9

PAGE 93-100



GAGE BLOCKS  
ANGLE GAGE BLOCKS  
PIN GAGE  
THREAD RING/PLUG GAGE  
CHECK MASTER

10

ANGLE AND STRAIGHTNESS PAGE 101-110



UNIVERSAL PROTRACTOR  
PERPENDICULARITY TESTER  
GRANITE SQUARE  
SQUARE  
PRECISION STRAIGHT EDGE

11

PAGE 110-123



PITCH GAGE  
RADIUS GAGE  
CHAMFER GAGE  
FEELER GAGE  
TAPER GAGE  
WELDING GAGE  
INSIDE/OUTSIDE CALIPER  
STEEL RULE  
COMBINATION SQUARE SET  
SCRIBING CALIPER  
SCRIBER  
CENTER PUNCH

12

MEASURING TOOL SET PAGE 123-126



MEASURING TOOL SET



# PRODUCT INDEX

13

PAGE 126-138



GRANITE SURFACE PLATE  
V-BLOCK SET  
1-2-3 BLOCKS  
PARALLEL SET  
RIGHT ANGLE PLATE  
PRECISION VISE  
CENTERING INDICATOR  
3D TESTER  
EDGE FINDER  
ZERO SETTER

14 SCALE

PAGE 138-140



DIGITAL SCALE  
LINEAR SCALE  
COUNTER

15

PAGE 141-146



CONTOUR MEASURING MACHINE  
PROFILE PROJECTOR  
VISION MEASURING SYSTEM

16 MICROSCOPE AND  
MAGNIFIER

PAGE 147-160



DIGITAL MEASURING MICROSCOPE  
ZOOM STEREO MICROSCOPE  
MAGNIFIER WITH ILLUMINATION  
TABLE MAGNIFIER WITH ILLUMINATION

17 BORESCOPE

PAGE 160-164



VIDEOSCOPE  
RIGID BORESCOPE

18 ROUGHNESS TESTER

PAGE 165-172

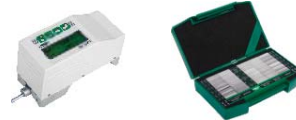

ROUGHNESS TESTER  
SURFACE ROUGHNESS SPECIMEN

20 LEVEL

PAGE 180-185



DIGITAL LEVEL AND PROTRACTOR  
BLOCK LEVEL

19

PAGE 172-179



COATING THICKNESS GAGE  
DIGITAL SURFACE PROFILE GAGE  
ULTRASONIC THICKNESS GAGE  
LASER DISTANCE METER  
INFRARED THERMOMETER  
DIGITAL ANEMOMETER  
DIGITAL MOISTURE METER  
DIGITAL SOUND LEVEL METER  
DIGITAL TACHOMETER  
GLOSS METER  
PORTABLE REFRACTOMETER

21 HARDNESS TESTER

PAGE 185-203



ROCKWELL HARDNESS TESTER  
PORTABLE LEEB HARDNESS TESTER  
SHORE DUROMETER

23 TORQUE TESTER  
TORQUE WRENCH

PAGE 205-213



DIGITAL TORQUE TESTER  
DIGITAL BOTTLE CAP TORQUE TESTER  
DIGITAL TORQUE SCREWDRIVER  
DIGITAL TORQUE WRENCH

22 FORCE GAGE

PAGE 203-205



DIGITAL FORCE GAGE  
DIAL TENSION GAGE



# MEASURING DATA MANAGEMENT SOFTWARE

## DATABASE COMPUTER

1. Make measurement program of inspection computers (set the dimension and tolerance to be measured of each inspection computer)
2. Receive data from inspection computers and make statistics



## INSPECTION COMPUTER



send program  
send data



send program  
send data

## INSPECTION COMPUTER



send program  
send data

## INSPECTION COMPUTER

1. Inspection computers are connected with database computer by wire or wireless LAN (Local Area Network). Maximum 128 inspection computers can be connected with one database computer.
2. Measuring tools are connected by data output cable or wireless data transfer system to USB port of inspection computers. Several measuring tools can be connected to one inspection computer.



## SOFTWARE FOR DATABASE COMPUTER PART NO. 7311-1

### make measurement program

workpiece information

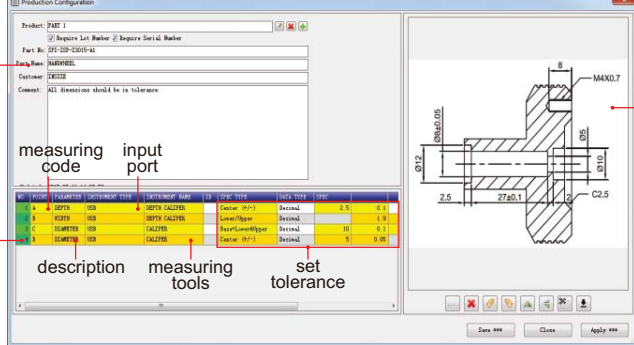

workpiece drawing

Make measurement program for each one inspection computer. Maximum 200 dimensions can be measured by one inspection computer.

### make data statistics



process control analysis

CPK analysis

overall equipment effectiveness analysis

### report

## SOFTWARE FOR INSPECTION COMPUTER PART NO. 7311-2

### step 1

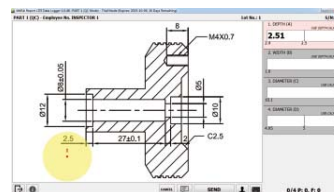

Measure the 1st dimension by following the yellow position indication.

### step 2

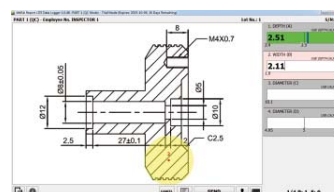

Measure the 2nd dimension by following the yellow position indication. The 1st data will be shown in red or green according to its tolerance.

### step 3

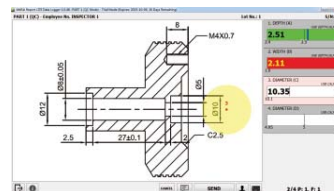

Measure the 3rd dimension by following the yellow position indication. The 2nd data will be shown in red or green according to its tolerance.

### step 4

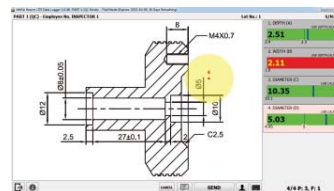

Measure the 4th dimension by following the yellow position indication. The 3rd data will be shown in red or green according to its tolerance. The data of four measurements will be sent to the database computer.

## WIRELESS DATA TRANSFER SYSTEM

**INSIZE PLUS**  
MADE IN USA

APPLICABLE FOR  
OTHER BRANDS

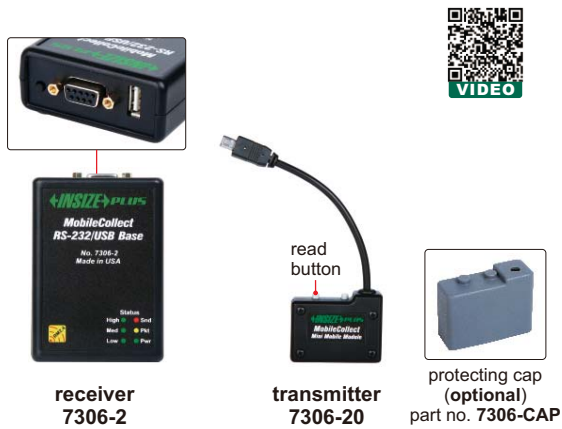

Part No.	Description	Remark
7306-2	receiver	USB and RS232 connection ports, for long distance (within 328ft)
7306-1	mini receiver	USB connection port, for short distance (within 65.6ft) or barrier-free area
7306-20	transmitter	for electronic calipers for electronic depth gages
7306-30A	transmitter	for electronic micrometers for electronic three points internal micrometers
7306-40	transmitter	for electronic indicators for electronic protractors

■ **CONNECTION:** one receiver can be connected to 30 transmitters.

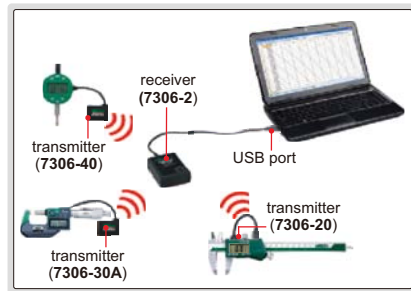

- **DATA COLLECTION:**
- 1) Single collection: press the read button once to collect the reading from measuring tool once.
  - 2) Multi collection: press the read button once to start collecting readings from measuring tools continuously, press the button again to stop collecting. Total collection times and interval time can be adjusted.

■ **DISPLAY:** data can be input to Excel as keyboard signal.

measuring tools code A, B, C

	A	B	C	
1	1.2345			
2	1.00234			
3	20.0023			
4	20.0023			
5	16.0090			
6	19.8900			
7	28.5300			
8	16.0023			
9	19.8900			
10	19.8900			
11	28.5300			
12	16.0023			
13	19.8900			
14	19.8900			
15	28.5300			
16	16.0023			

All data are displayed in the same column. Each measuring tool can be coded such as A, B, C, etc.

## DATA OUTPUT CABLES (KEYBOARD FORMAT)



without software, data can be input as keyboard signal to Excel, Word, etc.

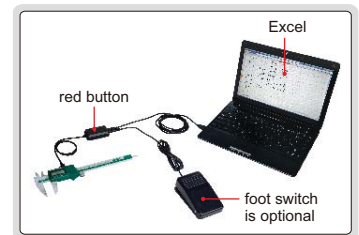

Part No.	Description	Plug type to product	Socket type on product	Plug type to computer	Applicable products
7302-SPC5A	cable for electronic calipers (length 100")			USB	for electronic calipers
7302-SPC5B					for electronic depth gages
7302-SPC6	cable for electronic micrometers (length 100")				for electronic micrometers for electronic three points internal micrometers
7302-SPC3A	cable for electronic indicators (length 100")				for electronic indicators for electronic protractors
7304-2	foot switch with cable (length 60")				
7302-HUB	HUB converter (length 12", four USB ports to computer)				

## DATA OUTPUT CABLES (TEXT FORMAT, VIRTUAL COM PORT)

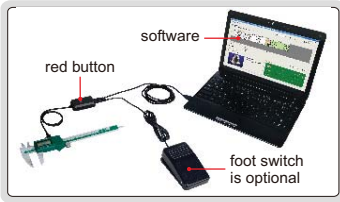

7305-C01



7305-SPC1A

### SEPARATED BUTTON

Part No.	Description	Plug type to product	Socket type on product	Plug type to computer	Applicable products	
7305-A01	cable for electronic calipers (length 100")			USB	for electronic calipers	for electronic height gages
7305-SPC2A				RS232	for electronic depth gages	
7305-A02				USB		
7305-B01	cable for electronic micrometers (length 100")			USB	for electronic micrometers	for electronic three points internal micrometers
7305-SPC3A				RS232		
7305-C01	cable for electronic indicators (length 100")			USB	for electronic indicators	for electronic protractors
7305-SPC1A				RS232		
7304-2	foot switch with cable (length 60")					
7302-HUB	HUB converter (length 12", four USB ports to computer)					



7304-2



7302-HUB

**ATTENTION:**  
NO DATA OUTPUT

**ATTENTION:** IT IS NECESSARY TO SET ZERO AFTER POWER ON EACH TIME

- IP67 dust/waterproof
- Resolution .0005"/0.01mm
- Button function: zero, on/off, inch/mm, ABS/REL, hold
- Battery CR2032
- Made of stainless steel

## ELECTRONIC WATERPROOF CALIPERS

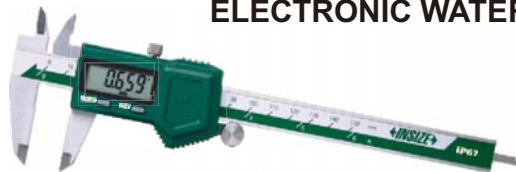

1118-150B

**INSPECTION CERTIFICATE**  
TRACEABLE TO NIST

**IP67 WATERPROOF**

Part No.	Range	Accuracy	L	a	b	c	d
1118-150B *	0-6"/0-150mm	±.0012"	9.291"	.827"	.630"	.630"	1.575"
1118-200B *	0-8"/0-200mm	±.0012"	11.260"	.945"	.748"	.630"	1.969"
1118-300B *	0-12"/0-300mm	±.0012"	15.748"	.984"	.807"	.669"	2.362"

\* Supplied with manufacturer inspection certificate traceable to NIST

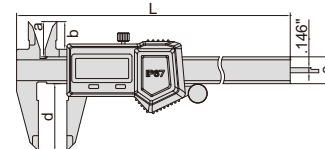

Measuring Length		Permissible Error	Error		Measuring Length		Permissible Error	Error	
			External	Internal				External	Internal
0.4 DIA		+0.0005 -0.0010	/	0.0005	Φ10		+0.01 -0.02	/	0.01
2	±0.0010	-0.0005	/	/	50	±0.02	-0.01	/	/
4		-0.0005	/	/	100		-0.01	/	/
6		-0.0010	/	/	150		-0.02	/	/
8		/	/	/	200		/	/	/
10	±0.0015	/	/	/	250	±0.03	/	/	/
12		/	/	/	300		/	/	/

**MANUFACTURER INSPECTION CERTIFICATE TRACEABLE TO NIST, FOR CALIPERS**



### ELECTRONIC CALIPERS

- Zinc alloy housing for electronic unit
- Resolution .0005"/0.01mm
- Buttons: zero, on/off, inch/mm
- Automatic power off, move the digital unit to turn on power
- Battery CR2032
- Made of stainless steel



1114-150A

**INSPECTION CERTIFICATE**  
TRACEABLE TO NIST

**ATTENTION:**  
NO DATA OUTPUT

Part No.	Range	Accuracy	L	a	b	c	d
1114-150A *	0-6"/0-150mm	±.0012"	9.291"	.827"	.630"	.630"	1.575"
1114-200A *	0-8"/0-200mm	±.0012"	11.260"	.945"	.748"	.630"	1.969"
1114-300A *	0-12"/0-300mm	±.0012"	15.748"	.984"	.807"	.669"	2.362"

\* Supplied with manufacturer inspection certificate traceable to NIST

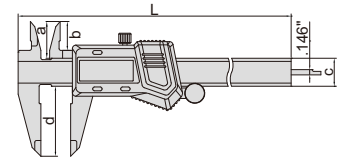

### ELECTRONIC CALIPERS (FRACTION READING)

- Resolution: 0.01mm, .0005", 1/128"
- Buttons: unit (mm/in/fraction), ABS, on/off, zero
- Absolute and incremental measurement
- Battery CR2032, automatic power off
- Made of stainless steel

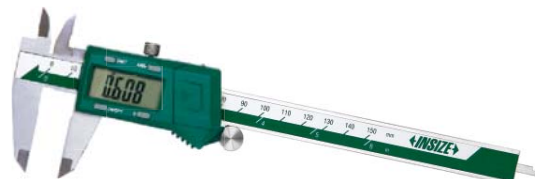

1102-150

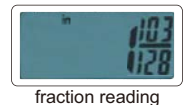

fraction reading

**ATTENTION:**  
NO DATA OUTPUT

Part No.	Range	Accuracy	L	a	b	c	d
1102-150 *	0-6"/0-150mm	±.0012"	9.213"	.787"	.591"	.630"	1.575"
1102-200 *	0-8"/0-200mm	±.0012"	11.260"	.945"	.748"	.630"	1.969"
1102-300 *	0-12"/0-300mm	±.0012"	15.354"	1.024"	.846"	.630"	2.362"

\* Supplied with manufacturer inspection certificate traceable to NIST

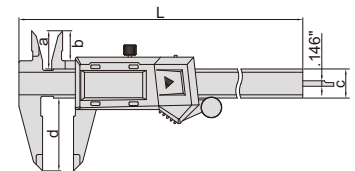

### ELECTRONIC CALIPERS (STANDARD MODEL)

- Resolution .0005"/0.01mm
- Buttons: on/off, zero, inch/mm
- Automatic power off, move the digital unit to turn on power
- Battery CR2032, data output
- Made of stainless steel
- Optional accessory: data output cable (part no. 7306-20, 7302-SPC5A/SPC5B, 7305-SPC2A, 7305-A01/A02)



1108-150

**DATA OUTPUT**

**INSPECTION CERTIFICATE**  
TRACEABLE TO NIST

Part No.	Range	Accuracy	L	a	b	c	d
1108-150 *	0-6"/0-150mm	±.0008"	9.291"	.827"	.630"	.630"	1.575"
1108-200 *	0-8"/0-200mm	±.0012"	11.260"	.945"	.748"	.630"	1.969"
1108-300 *	0-12"/0-300mm	±.0012"	15.748"	.984"	.807"	.630"	2.362"

\* Supplied with manufacturer inspection certificate traceable to NIST

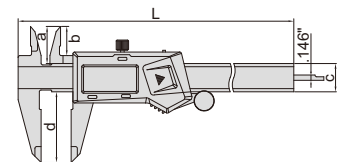

### ELECTRONIC CALIPER WITH ROUND DEPTH BAR

- Resolution .0005"/0.01mm
- Buttons: on/off, zero, inch/mm
- Automatic power off, move the digital unit to turn on power
- Battery CR2032, data output
- Made of stainless steel
- Optional accessory: data output cable (part no. 7306-20, 7302-SPC5A/SPC5B, 7305-SPC2A, 7305-A01/A02)



1119-150

**DATA OUTPUT**

**INSPECTION CERTIFICATE**  
TRACEABLE TO NIST

Part No.	Range	Accuracy	L	a	b	c	d
1119-150 *	0-6"/0-150mm	±.0012"	9.291"	.827"	.630"	.630"	1.575"

\* Supplied with manufacturer inspection certificate traceable to NIST



round depth bar .063" DIA

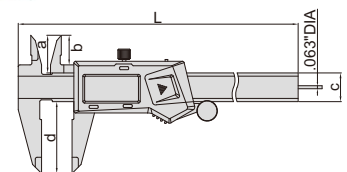



**INSPECTION  
CERTIFICATE**  
TRACEABLE TO NIST

DATA  
OUTPUT

## HEAVY DUTY 12" ELECTRONIC CALIPER

2

- Resolution .0005"/0.01mm
- Buttons: on/off, zero, inch/mm
- Automatic power off, move the digital unit to turn on power
- Battery CR2032
- Data output
- Made of stainless steel
- Optional accessory: data output cable (part no. 7306-20, 7302-SPC5A/SPC5B, 7305-SPC2A, 7305-A01/A02)



1196-300

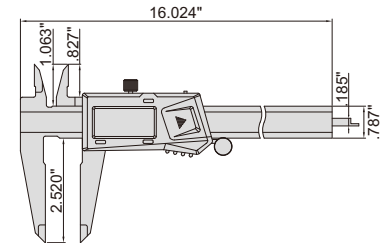

Part No.	Range	Accuracy
1196-300*	0-12"/0-300mm	±.0012"

\* Supplied with manufacturer inspection certificate traceable to NIST

**INSPECTION  
CERTIFICATE**  
TRACEABLE TO NIST

DATA  
OUTPUT

## ELECTRONIC CALIPERS WITH CARBIDE TIPPED JAWS

- Carbide tipped jaws for inside and outside measurements
- Resolution .0005"/0.01mm
- Buttons: on/off, zero, inch/mm
- Automatic power off, move the digital unit to turn on power
- Battery CR2032
- Data output
- Made of stainless steel
- Optional accessory: data output cable (part no. 7306-20, 7302-SPC5A/SPC5B, 7305-SPC2A, 7305-A01/A02)



1110-150A

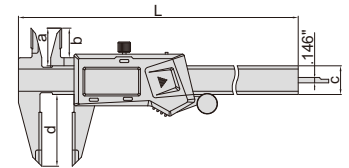

Part No.	Range	Accuracy	L	a	b	c	d
1110-150A*	0-6"/0-150mm	±.0012"	9.291"	.827"	.630"	.630"	1.575"
1110-200A*	0-8"/0-200mm	±.0012"	11.260"	.945"	.748"	.630"	1.969"
1110-300A*	0-12"/0-300mm	±.0012"	15.748"	.984"	.807"	.630"	2.362"

\* Supplied with manufacturer inspection certificate traceable to NIST

**INSPECTION  
CERTIFICATE**  
TRACEABLE TO NIST

DATA  
OUTPUT

## ELECTRONIC CALIPERS WITH CERAMIC TIPPED JAWS

- Ceramic tipped jaws for outside measurement, extremely wear-resistant, non-magnetic, non-conductive
- Resolution .0005"/0.01mm
- Buttons: on/off, zero, inch/mm
- Automatic power off, move the digital unit to turn on power
- Battery CR2032
- Data output
- Made of stainless steel
- Optional accessory: data output cable (part no. 7306-20, 7302-SPC5A/SPC5B, 7305-SPC2A, 7305-A01/A02)



1193-150

ceramic tipped jaws

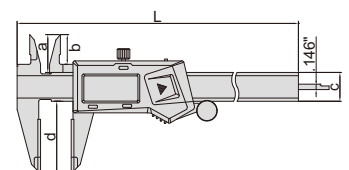

Part No.	Range	Accuracy	L	a	b	c	d
1193-150*	0-6"/0-150mm	±.0012"	9.252"	.827"	.650"	.630"	1.575"
1193-200*	0-8"/0-200mm	±.0012"	11.693"	.945"	.787"	.630"	1.969"
1193-300*	0-12"/0-300mm	±.0012"	15.354"	1.024"	.846"	.630"	2.362"

\* Supplied with manufacturer inspection certificate traceable to NIST

5

## ELECTRONIC LEFT HAND CALIPERS

- Designed for left handed users
- Resolution .0005"/0.01mm
- Buttons: on/off, zero, inch/mm
- Automatic power off, move the digital unit to turn on power
- Battery CR2032, data output
- Made of stainless steel
- Optional accessory: data output cable (part no. 7306-20, 7302-SPC5A/SPC5B, 7305-SPC2A, 7305-A01/A02)

**INSPECTION  
CERTIFICATE**  
TRACEABLE TO NIST

DATA  
OUTPUT



1130-150

Part No.	Range	Accuracy	L	a	b	c	d
1130-150*	0-6"/0-150mm	±.0012"	9.291"	.827"	.630"	.630"	1.575"
1130-200*	0-8"/0-200mm	±.0012"	11.260"	.945"	.748"	.630"	1.969"
1130-300*	0-12"/0-300mm	±.0012"	15.748"	.984"	.807"	.630"	2.362"

\* Supplied with manufacturer inspection certificate traceable to NIST

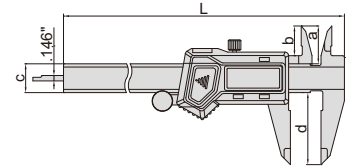

## MINI ELECTRONIC CALIPERS

- Resolution .0005"/0.01mm
- Buttons: zero, inch/mm, on/off
- Automatic power off, move the digital unit to turn on power
- Battery LR44
- Made of stainless steel

ATTENTION:  
NO DATA OUTPUT



1111-100A

Part No.	Range	Accuracy	L
1111-75A	0-3"/0-75mm	±.0008"	5.669"
1111-100A	0-4"/0-100mm	±.0008"	6.693"

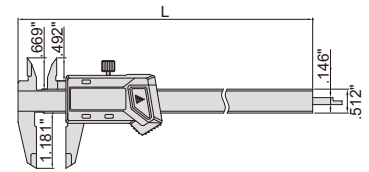

## ELECTRONIC CALIPER

- Resolution .0005"/0.01mm
- Buttons: on/off, zero, inch/mm
- Automatic power off, move the digital unit to turn on power
- Battery CR2032
- Data output
- Made of stainless steel
- Optional accessory: data output cable (part no. 7306-20, 7302-SPC5A/SPC5B, 7305-SPC2A, 7305-A01/A02)

DATA  
OUTPUT



1522-127

Part No.	Range	Accuracy
1522-127	0-12"/0-300mm	±.0016"

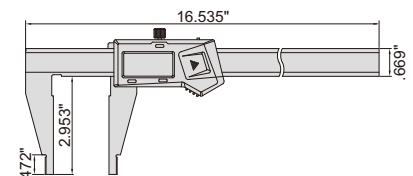
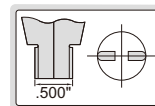

## ELECTRONIC CALIPER

- Resolution .0005"/0.01mm
- Buttons: on/off, zero, inch/mm
- Automatic power off, move the digital unit to turn on power
- Battery CR2032
- Data output
- Made of stainless steel
- Optional accessory: data output cable (part no. 7306-20, 7302-SPC5A/SPC5B, 7305-SPC2A, 7305-A01/A02)

DATA  
OUTPUT



1523-127

Part No.	Range	Accuracy
1523-127	0-12"/0-300mm	±.0016"

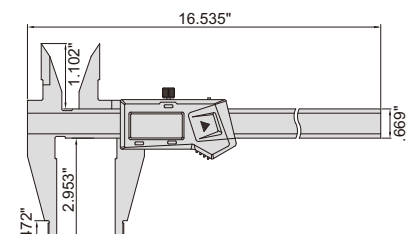
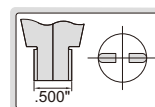



**ATTENTION:  
NO DATA OUTPUT**

- Made of hard plastic, non-magnetic and non electric conductive
- Prevent workpieces from scratching by calipers
- Resolution .0005"/0.01mm
- Buttons: on/off, zero, inch/mm
- Battery CR2032, automatic power off

## ELECTRONIC PLASTIC CALIPER



1139-150

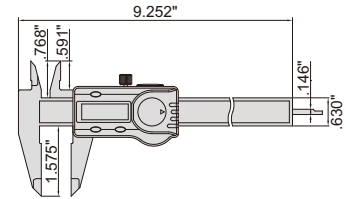

Part No.	Range	Accuracy
1139-150	0-6"/0-150mm	±.004"

**DATA OUTPUT**

- Resolution .0005"/0.01mm
- Button function: on/off, zero, inch/mm, ABS, data preset
- Battery CR2032, data output
- Made of stainless steel
- Optional accessory: data output cable (part no. 7306-20, 7302-SPC5A/SPC5B, 7305-SPC2A, 7305-A01/A02)

## ELECTRONIC CALIPERS



1131-24

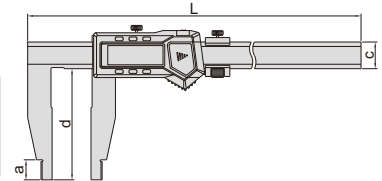

Part No.	Range	Accuracy	a	c	d	e	L
1131-24	0-24"/0-600mm	±.0020"	.709"	.945"	3.937"	.800"	30.315"
1131-40	0-40"/0-1000mm	±.0031"	.945"	1.220"	5.906"	.800"	48.031"
1131-60	0-60"/0-1500mm	±.0043"	.945"	1.654"	5.906"	.800"	70.079"
1131-80	0-80"/0-2000mm	±.0055"	.945"	1.654"	5.906"	.800"	90.157"

**DATA OUTPUT**

- Resolution .0005"/0.01mm
- Button function: on/off, zero, inch/mm, ABS, data preset
- Battery CR2032, data output
- Made of stainless steel
- Optional accessory: data output cable (part no. 7306-20, 7302-SPC5A/SPC5B, 7305-SPC2A, 7305-A01/A02)

## ELECTRONIC CALIPERS



1133-24

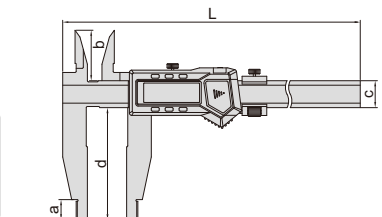

Part No.	Range	Accuracy	a	b	c	d	e	L
1133-24	0-24"/0-600mm	±.0020"	.709"	1.772"	.945"	3.937"	.800"	30.315"
1133-40	0-40"/0-1000mm	±.0031"	.945"	2.362"	1.220"	5.906"	.800"	48.031"

**SHOCK PROOF**

- Resolution .0005"/0.01mm
- Button function: on/off, zero, inch/mm, ABS, data preset
- Battery CR2032, data output
- Made of stainless steel
- Optional accessory: data output cable (part no. 7306-20, 7302-SPC5A/SPC5B, 7305-SPC2A, 7305-A01/A02)

## ELECTRONIC CALIPERS



1135-601

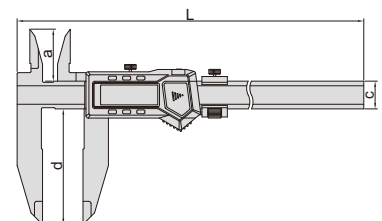

Part No.	Range	Accuracy	a	c	d	L
1135-451	0-18"/0-450mm	±.0020"	1.772"	.945"	3.937"	24.606"
1135-601	0-24"/0-600mm	±.0020"	1.772"	.945"	3.937"	30.315"
1135-1002	0-40"/0-1000mm	±.0031"	2.362"	1.220"	5.906"	48.031"

## DIAL CALIPERS

- Shockproof dial indicator
- Made of stainless steel



SHOCK PROOF

INSPECTION CERTIFICATE  
TRACEABLE TO NIST

### Dial indicator graduation .001"

1311-6

Part No.	Range	Accuracy	L	a	b	c	d	D	t
1311-4*	0-4"	±.0012"	6.496"	.709"	.472"	.512"	1.181"	1.260" DIA	.228"
1311-6*	0-6"	±.0015"	9.252"	.827"	.650"	.630"	1.575"	1.535" DIA	.256"
1311-8*	0-8"	±.0020"	11.339"	.945"	.748"	.630"	1.890"	1.535" DIA	.256"
1311-12*	0-12"	±.0020"	16.142"	1.102"	.866"	.787"	2.441"	1.752" DIA	.295"

### Dial indicator graduation 0.01mm

Part No.	Range	Accuracy	L	a	b	c	d	D	t
1311-150A*	0-150mm	±0.03mm	235mm	21mm	16.5mm	16mm	40mm	Ø39mm	6.5mm
1311-200A*	0-200mm	±0.03mm	288mm	24mm	19mm	16mm	48mm	Ø39mm	6.5mm
1311-300A*	0-300mm	±0.03mm	410mm	28mm	22mm	20mm	62mm	Ø44.5mm	7.5mm

\* Supplied with manufacturer inspection certificate traceable to NIST

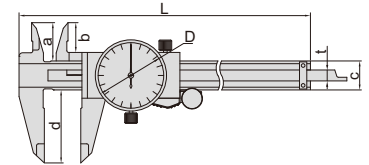

## DIAL CALIPERS

SHOCK PROOF



1316-18

- Shockproof dial indicator
- Graduation .001"
- Made of stainless steel

Part No.	Range	Accuracy	L
1316-18	0-18"	±.0020"	22.835"
1316-24	0-24"	±.0020"	28.740"

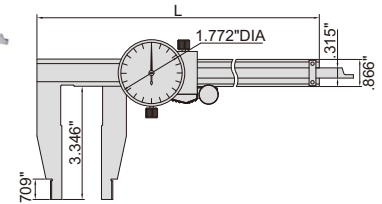
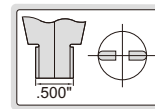

## VERNIER CALIPERS

- Graduation .001"/0.02mm
- Made of stainless steel
- Satin chrome plated reading surface



1205-1502E

Part No.	Range	Accuracy	L	a	b	c	d
1205-1502E	0-6"/0-150mm	±.0012"	9.252"	.807"	.610"	.630"	1.575"
1205-2002E	0-8"/0-200mm	±.0012"	11.417"	.925"	.748"	.669"	1.969"
1205-3002E	0-12"/0-300mm	±.0012"	16.299"	1.083"	.866"	.787"	2.520"

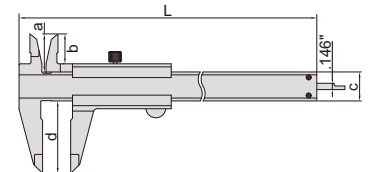

## VERNIER CALIPERS

- With fine adjustment
- Made of stainless steel
- Satin chrome plated reading surface



1211-24

Part No.	Range	Graduation	Accuracy	Graduation on scale	a	c	d	e	L
1211-12	0-12"	.001"	±.002"	inch on bottom and top	.394"	.787"	2.953"	.500"	16.142"
1211-24	0-24"/0-600mm	.001"/0.02mm	±.002"	inch on bottom, metric on top	.709"	.945"	3.937"	.800"	30.315"
1211-40	0-40"/0-1000mm	.001"/0.02mm	±.0031"	inch on bottom, metric on top	.945"	1.26"	5.512"	.800"	47.874"

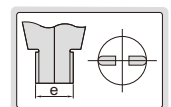
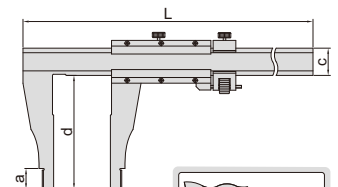

## DEPTH BASE ATTACHMENTS

- To increase the stability of depth measurement
- Suitable for electronic calipers and dial calipers
- Made of stainless steel



6140

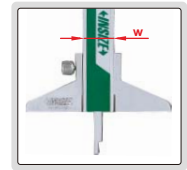
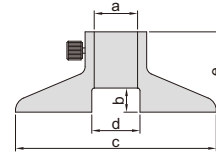

Part No.	a	b	c	d	e	Application
6140	.650"	.354"	2.953"	.709"	1.181"	Suitable for calipers with beam width (w) .630"
6140-300A	.787"	.591"	4.921"	.866"	1.339"	Suitable for calipers with beam width (w) .787"

## ACCESSORY SET FOR ELECTRONIC CALIPERS PART NO. 6144

measuring external groove diameter ( $h1 \leq .138"$ )

measuring internal groove diameter ( $h2 \leq .138"$ )

measuring center distance

spherical points for groove diameter (inside hole) measurement

flat points for external groove diameter measurement

6144

.374" DIA  
.146"  
1.969"  
.118" DIA  
2-M3x0.5mm  
.079" DIA  
.118"  
M3.0x0.5mm

.118" DIA  
1.969"  
.031"  
.394" DIA

disk points (stainless steel)

.394" DIA  
.118" DIA  
1.18"  
60°  
.394"

conical points (stainless steel)

.079" DIA  
.472"  
.079" SR

spherical/flat points (stainless steel)

- Suitable for 0-6"/0-150mm and 0-8"/0-200mm electronic calipers (thickness of lower jaws  $\leq .146"$ )



Part No.  
6144

## CUSTOM-MADE CALIPER

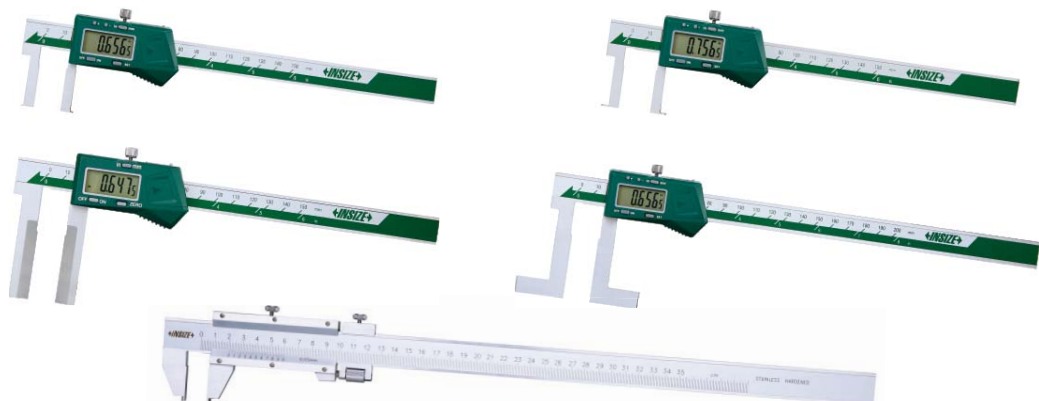

- We are able to make calipers according to the design from customers



## UNIVERSAL CALIPER PART NO. 1125-600

DATA  
OUTPUT

working with stands

working with measuring jaws



1125-600

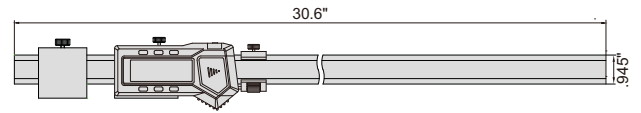

- Buttons: on/off, set, inch/mm, ABS, preset (+, -)
- Automatic power off, move the digital unit to turn on power
- Battery CR2032
- Data output
- Made of stainless steel
- Optional accessory: data output cable (part no. 7306-20, 7302-SPC5A/SPC5B, 7305-SPC2A, 7305-A01/A02)



Part No.	Range*	Resolution	Accuracy
1125-600	0-24"/0-600mm	.0005"/0.01mm	±.002"

\*The range changes according to different points

### Half disk points (included)

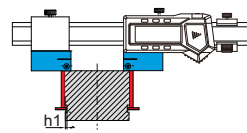
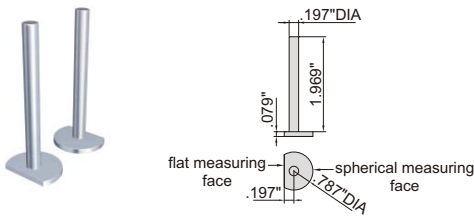

Measuring external groove diameter with flat measuring face (depth  $h1 \leq 0.098"$ )

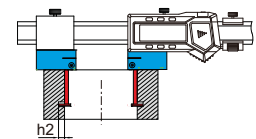

Measuring internal groove diameter with spherical measuring face (depth  $h2 \leq 0.295"$ )

### Conical points (optional)

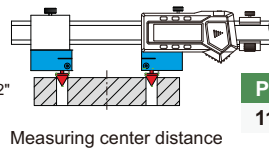
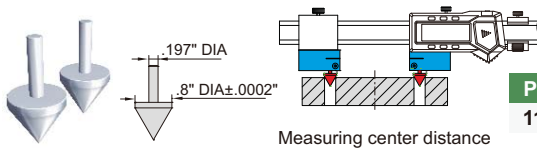

Measuring center distance

Part No.  
1125-T101-1

### Round shoulder points (optional)

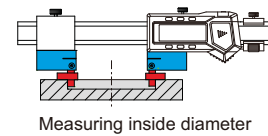
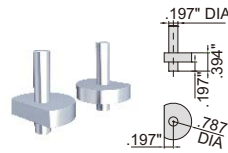

Measuring inside diameter

Part No.  
1125-T102

### Flat shoulder points (optional)

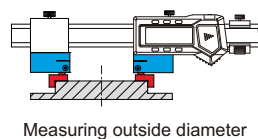
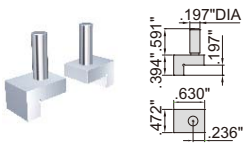

Measuring outside diameter

Part No.  
1125-T103

### Spherical points (included)

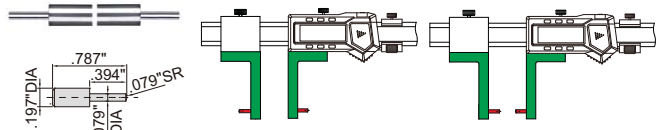

### Point sleeve (optional)

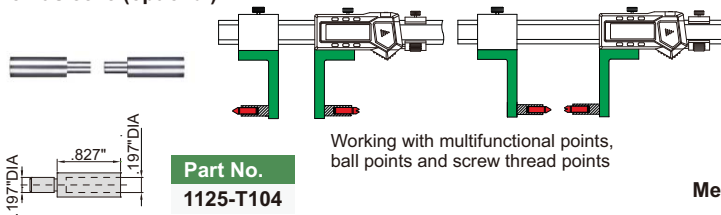

Part No.  
1125-T104

Working with multifunctional points, ball points and screw thread points

### Stands (included)

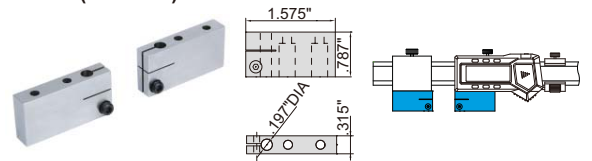

### Measuring jaws (included)

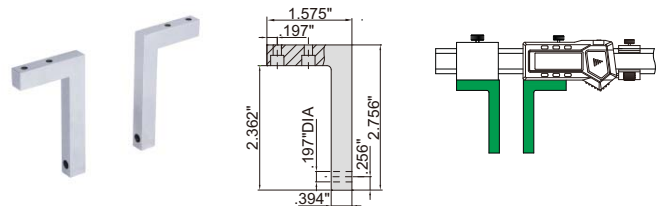

### Depth stop (included)

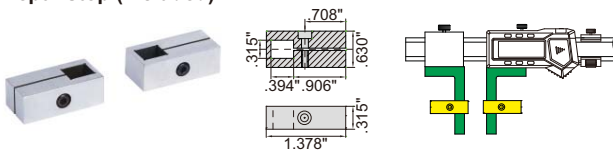

### Multifunctional points 7392 (optional, next page)



### Ball points 7391 (optional, next page)



### Screw thread points 7381, 7321 (optional, next page)



# ELECTRONIC CALIPER WITH INTERCHANGEABLE POINTS

## PART NO. 1526-200

short spherical points (included)



long spherical/flat points (included)

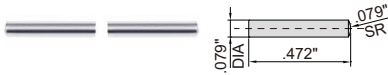

spherical blade points (included)

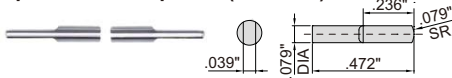

DATA OUTPUT



1526-200

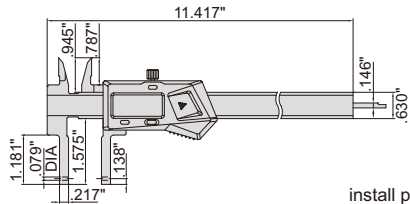

- Supplied with 3 pairs of points and zero setting block for external measurement
- Resolution .0005"/0.01mm
- Buttons: on/off, set, inch/mm, preset (+, -)
- Automatic power off, move the digital unit to turn on power
- Battery CR2032, data output
- Made of stainless steel
- Optional accessory: points (part no. 1526-T101, 7392, 7391, 7381, 7321), depth stop (part no. 6143), data output cable (part no. 7306-20, 7302-SPC5A/SPC5B, 7305-SPC2A, 7305-A01/A02)

preset buttons



install points

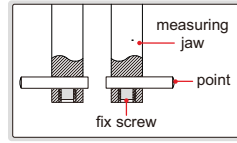

measure internal and external grooves

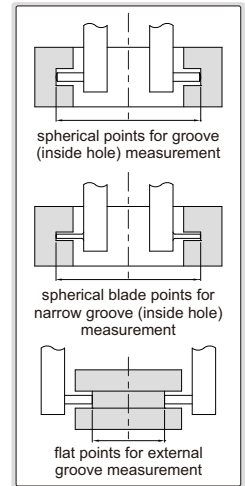

Point	Range	Accuracy	Application
short spherical points	.5-8.5"/12-212mm (internal)	±.0012"	for grooves inside small hole
long spherical/flat points	1-8.8"/24-224mm (internal) 0-7.5"/0-187mm (external)	±.0012"	spherical points for grooves inside hole flat points for external grooves
spherical blade points	1-8.8"/24-224mm (internal) 0-7.5"/0-187mm (external)	±.0012"	for narrow grooves inside hole

zero setting block for external measurement (included)



Depth stop (optional)

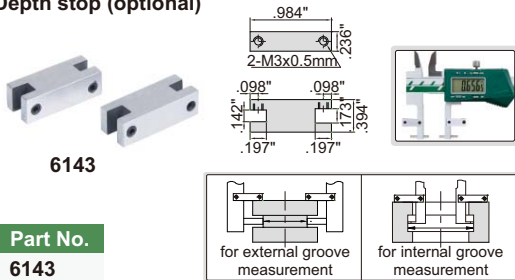

Multifunctional points (optional)

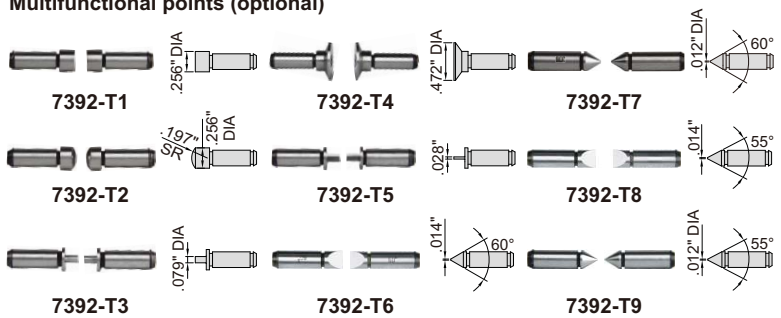

Part No.	Type	Part No.	Type	Part No.	Type
7392-T1*	flat	7392-T4*	disk	7392-T7*	point
7392-T2*	spherical	7392-T5*	blade	7392-T8*	knife-edge
7392-T3*	spline	7392-T6*	knife-edge	7392-T9*	point

\* It is necessary to use point sleeve (part no. 1526-T101) for these points

Point sleeve (optional)

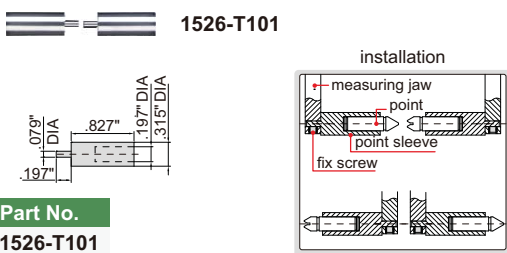

Screw thread points (optional)



Ball points (optional)

Part No.	Ball dia.(D)
7391-T3*	.079" DIA
7391-T4*	.098" DIA
7391-T5*	.118" DIA
7391-T6*	.138" DIA
7391-T7*	.157" DIA
7391-T8*	.177" DIA
7391-T9*	.197" DIA
7391-T10*	.236" DIA

7391-T5

7391-T10

\* It is necessary to use point sleeve (part no. 1526-T101) for these points

Internal thread (60° thread angle)

Part No.	Pitch
7321-T11*	64-48TPI/0.4-0.5mm
7321-T12*	44-28TPI/0.6-0.9mm
7321-T13*	24-14TPI/1-1.75mm
7321-T14*	13-9TPI/2-3mm
7321-T15*	8-5TPI/3.5-5mm
7321-T16*	4.5-3.5TPI/5.5-7mm
7321-T1S*	6 pairs/set, including all above points

External thread (60° thread angle)

Part No.	Pitch
7381-T11*	64-48TPI/0.4-0.5mm
7381-T12*	44-28TPI/0.6-0.9mm
7381-T13*	24-14TPI/1-1.75mm
7381-T14*	13-9TPI/2-3mm
7381-T15*	8-5TPI/3.5-5mm
7381-T16*	4.5-3.5TPI/5.5-7mm
7381-TS*	6 pairs/set, including all above points

## ELECTRONIC CALIPER WITH INTERCHANGEABLE POINTS PART NO. 1124-300A

DATA  
OUTPUT



2

short spherical/flat points (included)



long spherical/flat points (included)



short spherical blade points (included)

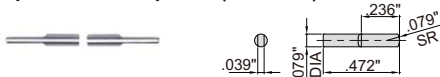

long spherical blade points (included)

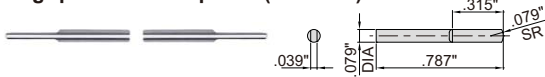

- Supplied with 4 pairs of points and zero setting block for external measurement
- Resolution .0005"/0.01mm
- Buttons: on/off, set, inch/mm, preset (+, -)
- Automatic power off, move the digital unit to turn on power
- Battery CR2032
- Data output
- Made of stainless steel
- Optional accessory: points (part no. 1526-T101, 7392, 7391, 7381, 7321), depth stop (part no. 6143), data output cable (part no. 7306-20, 7302-SPC5A/SPC5B, 7305-SPC2A, 7305-A01/A02)



1124-300A

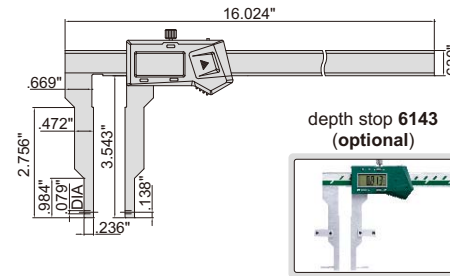

depth stop 6143  
(optional)

preset buttons

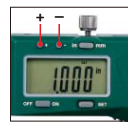

install points

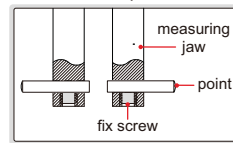

measure internal and  
external grooves

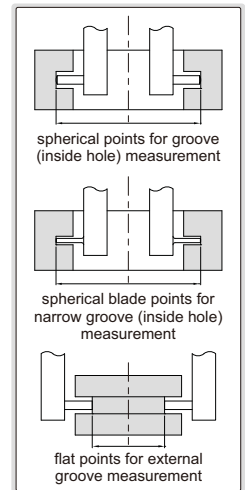

zero setting block for  
external measurement  
(included)



Point	Range	Accuracy	Application
short spherical/flat points	1-12.7"/24-324mm (internal) 0-11.3"/0-288mm (external)	±.0016"	spherical points for grooves inside hole (small hole) flat points for external grooves
long spherical/flat points	1.5-13.3"/40-340mm (internal) 0-10.7"/0-272mm (external)	±.0016"	spherical points for grooves inside hole (large hole) flat points for external grooves
short spherical blade points	1-12.7"/24-324mm (internal) 0-11.3"/0-288mm (external)	±.0016"	for narrow grooves inside hole (small hole)
long spherical blade points	1.5-13.3"/40-340mm(internal) 0-10.7"/0-272mm(external)	±.0016"	for narrow grooves inside hole (large hole)

Multifunctional points 7392  
(optional, refer to 1526-200 for more details)



Ball points 7391  
(optional, refer to 1526-200 for more details)



Screw thread points 7381, 7321  
(optional, refer to 1526-200 for more details)



## ELECTRONIC INSIDE GROOVE CALIPERS

DATA  
OUTPUT

- Measure groove diameter
- Resolution .0005"/0.01mm
- Buttons: on/off, set, inch/mm, preset (+, -)
- Automatic power off, move the digital unit to turn on power
- Battery CR2032, data output
- Made of stainless steel
- Optional accessory: depth stop (part no. 6143), data output cable (part no. 7306-20, 7302-SPC5A/SPC5B, 7305-SPC2A, 7305-A01/A02)



1120-150AE

preset buttons

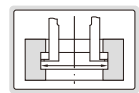
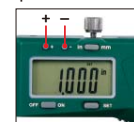

depth stop 6143  
(optional)

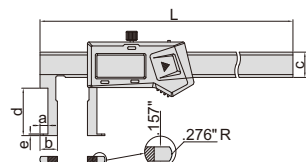

Part No.	Range	Accuracy	L	a	b	c	d	e
1120-150AE	1-6"/25.4-150mm	±.0016"	9.843"	.197"	.5000"	.630"	1.181"	.039"
1120-200A	1-8"/25-200mm	±.0016"	12.205"	.197"	.4921"	.630"	1.575"	.039"
1120-300A	1.2-12"/30-300mm	±.0020"	16.142"	.197"	.5906"	.669"	1.969"	.059"

**DATA OUTPUT**

## ELECTRONIC INSIDE POINT CALIPERS

2

- Measure groove diameter
- Resolution .0005"/0.01mm
- Buttons: on/off, set, inch/mm, preset (+, -)
- Automatic power off, move the digital unit to turn on power
- Battery CR2032, data output
- Made of stainless steel
- Optional accessory: depth stop (part no. 6143), data output cable (part no. 7306-20, 7302-SPC5A/SPC5B, 7305-SPC2A, 7305-A01/A02)



1121-150A

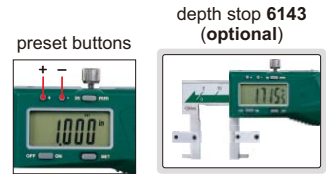

Part No.	Range	Accuracy	L	a	b	c	d	D
1121-150A	.9-6"/24-150mm	±.0016"	9.843"	.197"	.4724"	.630"	1.181"	.079" DIA
1121-200A	1-8"/25-200mm	±.0016"	12.205"	.197"	.4921"	.630"	1.575"	.079" DIA
1121-3001A	2-12"/50-300mm	±.0024"	16.142"	.315"	.9843"	.669"	3.150"	.118" DIA

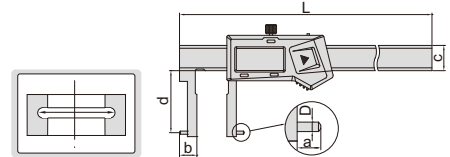

**DATA OUTPUT**

## ELECTRONIC INSIDE GROOVE CALIPER

depth stop 6143 (optional)



1176-150

- Measure diameter of grooves inside bores
- Resolution .0005"/0.01mm
- Buttons: on/off, set, inch/mm, preset (+, -)
- Automatic power off, move the digital unit to turn on power
- Battery CR2032
- Data output
- Made of stainless steel
- Optional accessory: depth stop (part no. 6143), data output cable (part no. 7306-20, 7302-SPC5A/SPC5B, 7305-SPC2A, 7305-A01/A02)

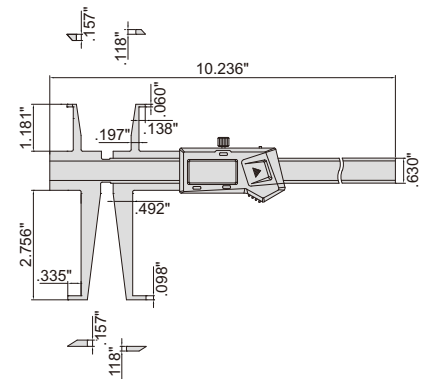

sizes to be measured (use upper jaws)

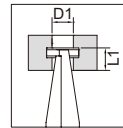

D1	L1
.354" DIA	<.315"
.394" DIA	<.591"
.433"-6" DIA	<1.181"

sizes to be measured (use lower jaws)

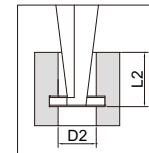

D2	L2
.590" DIA	<.394"
.630" DIA	<.709"
.669" DIA	<1.024"
.709" DIA	<1.339"
.748" DIA	<1.654"
.787" DIA	<1.969"
.827" DIA	<2.283"
.866"-6" DIA	<2.756"

Part No.	Range of upper jaw	Range of lower jaw	Accuracy
1176-150	.35-6"/9-150mm	.59-6"/15-150mm	±.0016"

**DATA OUTPUT**

## ELECTRONIC INSIDE GROOVE CALIPER

- Measure diameter of grooves inside bores
- Resolution .0005"/0.01mm
- Buttons: on/off, set, inch/mm, preset (+, -)
- Automatic power off, move the digital unit to turn on power
- Battery CR2032, data output
- Made of stainless steel
- Optional accessory: depth stop (part no. 6143), data output cable (part no. 7306-20, 7302-SPC5A/SPC5B, 7305-SPC2A, 7305-A01/A02)



1178-300

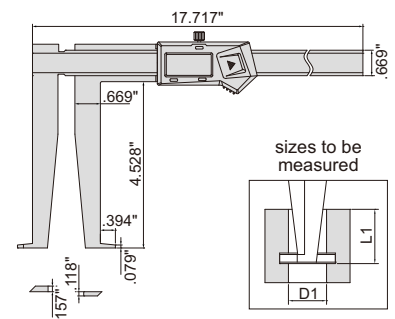
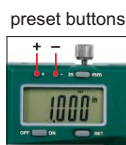

sizes to be measured

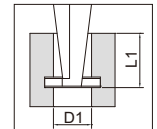

D1	L1
.984" DIA	<1.968"
1.024" DIA	<2.362"
1.063"-12" DIA	<4.331"

Part No.	Range	Accuracy
1178-300	1.18-12"/25-300mm	±.0020"



## ELECTRONIC INSIDE GROOVE CALIPER

- Measure diameter of grooves inside small bores
- Resolution .0005"/0.01mm
- Buttons: on/off, set, inch/mm, preset (+, -)
- Automatic power off, move the digital unit to turn on power
- Battery CR2032
- Data output
- Made of stainless steel
- Optional accessory: depth stop (part no. 6143), data output cable (part no. 7306-20, 7302-SPC5A/SPC5B, 7305-SPC2A, 7305-A01/A02)



1520-150

DATA OUTPUT

preset buttons



depth stop 6143 (optional)

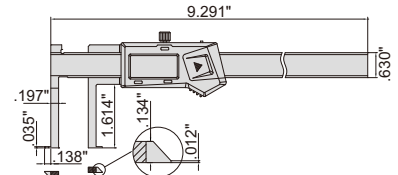
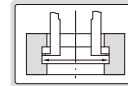

Part No.	Range	Accuracy
1520-150	.43-6"/11-150mm	±.0016"

## ELECTRONIC OUTSIDE NECK CALIPER

- Measure grooves and recesses
- Resolution .0005"/0.01mm
- Buttons: on/off, zero, inch/mm
- Automatic power off, move the digital unit to turn on power
- Battery CR2032
- Data output
- Made of stainless steel
- Optional accessory: depth stop (part no. 6143), data output cable (part no. 7306-20, 7302-SPC5A/SPC5B, 7305-SPC2A, 7305-A01/A02)



1187-150A

DATA OUTPUT

depth stop 6143 (optional)

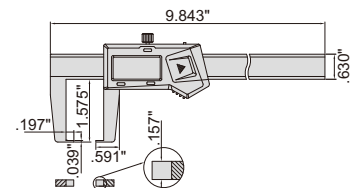
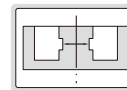

Part No.	Range	Accuracy
1187-150A	0-6"/0-150mm	±.0016"

## ELECTRONIC OUTSIDE POINT CALIPER

- Measure wall thickness inside bores and recesses
- Resolution .0005"/0.01mm
- Buttons: on/off, zero, inch/mm
- Automatic power off, move the digital unit to turn on power
- Battery CR2032
- Data output
- Made of stainless steel
- Optional accessory: depth stop (part no. 6143), data output cable (part no. 7306-20, 7302-SPC5A/SPC5B, 7305-SPC2A, 7305-A01/A02)



1185-150A

DATA OUTPUT

depth stop 6143 (optional)

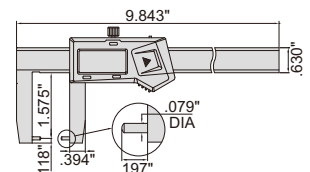
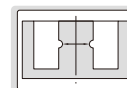

Part No.	Range	Accuracy
1185-150A	0-6"/0-150mm	±.0016"

## DEPTH STOP FOR CALIPERS

- Supplied in pair
- Made of stainless steel
- Suitable for caliper series 1124, 1526, 1520, 1176, 1178, 1120, 1121, 1187 and 1185



6143

Part No. 6143

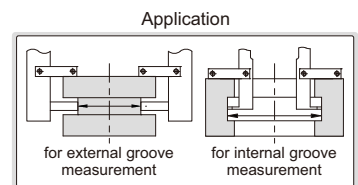
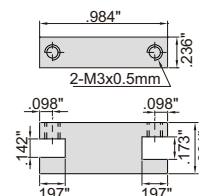

## DATA OUTPUT

## ELECTRONIC BLADE CALIPERS

- The blade jaws fit into small grooves
- Resolution .0005"/0.01mm
- Buttons: on/off, zero, inch/mm
- Automatic power off, move the digital unit to turn on power
- Battery CR2032, data output
- Made of stainless steel
- Optional accessory: data output cable (part no. 7306-20, 7302-SPC5A/SPC5B, 7305-SPC2A, 7305-A01/A02)



1188-150A

Part No.	Range	Accuracy	L	a	b	c	d	e	g
1188-150A	0-6"/0-150mm	±.0012"	9.291"	.827"	.630"	.630"	1.575"	.030"	.669"
1188-200A	0-8"/0-200mm	±.0012"	11.260"	.945"	.748"	.630"	1.969"	.030"	.669"
1188-300A	0-12"/0-300mm	±.0016"	15.748"	.984"	.807"	.669"	2.362"	.039"	.669"

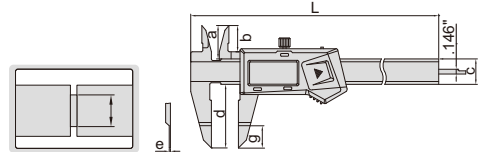

## DATA OUTPUT

## ELECTRONIC SMALL POINT CALIPER

- Small pointed jaws fit into small grooves and recesses
- Resolution .0005"/0.01mm
- Buttons: on/off, zero, inch/mm
- Automatic power off, move the digital unit to turn on power
- Battery CR2032, data output
- Made of stainless steel
- Optional accessory: data output cable (part no. 7306-20, 7302-SPC5A/SPC5B, 7305-SPC2A, 7305-A01/A02)



1169-150

Part No.	Range	Accuracy
1169-150	0-6"/0-150mm	±.0012"

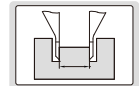
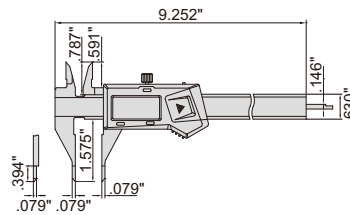

## DATA OUTPUT

## ELECTRONIC POINT CALIPER

- Pointed jaws fit into small grooves and recesses
- Resolution .0005"/0.01mm
- Buttons: on/off, zero, inch/mm
- Automatic power off, move the digital unit to turn on power
- Battery CR2032, data output
- Made of stainless steel
- Optional accessory: data output cable (part no. 7306-20, 7302-SPC5A/SPC5B, 7305-SPC2A, 7305-A01/A02)



1183-150A

Part No.	Range	Accuracy
1183-150A	0-6"/0-150mm	±.0012"

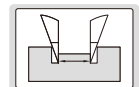
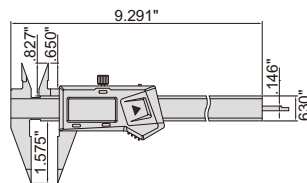

## DATA OUTPUT

## ELECTRONIC INSIDE KNIFE-EDGE CALIPER

- Measure diameter of deep step holes
- Resolution .0005"/0.01mm
- Buttons: on/off, zero, inch/mm
- Automatic power off, move the digital unit to turn on power
- Battery CR2032
- Data output
- Made of stainless steel
- Optional accessory: data output cable (part no. 7306-20, 7302-SPC5A/SPC5B, 7305-SPC2A, 7305-A01/A02)



1123-150A

Part No.	Range	Accuracy
1123-150A	.6-6"/15-150mm	±.0020"

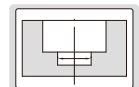
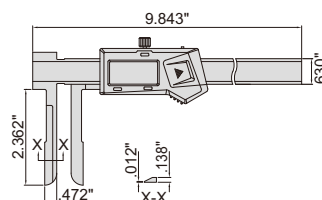

## ELECTRONIC OFFSET CENTERLINE CALIPERS

DATA OUTPUT

- Measure hole center distance in the same or offset planes
- Resolution .0005"/0.01mm
- Buttons: on/off, set, inch/mm, preset (+, -)
- Automatic power off, move the digital unit to turn on power
- Battery CR2032
- Data output
- Made of stainless steel
- Optional accessory: data output cable (part no. 7306-20, 7302-SPC5A/SPC5B, 7305-SPC2A, 7305-A01/A02)



1192-300AE

Part No.	Range	Accuracy	c	D (DIA)	L1	L2	L
1192-300AE	.4-12"/10.5-300mm	±.0035"	.630"	.4"	1.260"	2.559"	15.591"
1192-500AE	.8-20"/20.5-500mm	±.0035"	.945"	.8"	1.890"	3.465"	27.008"
1192-1000AE	1.2-40"/30.5-1000mm	±.0047"	1.220"	1.2"	1.890"	3.465"	48.898"
1192-1500AE	1.2-60"/30.5-1500mm	±.0059"	1.220"	1.2"	1.890"	3.465"	68.701"

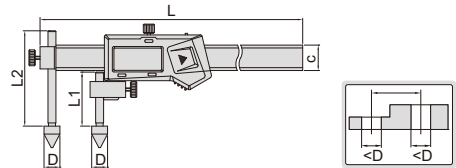

## ELECTRONIC BACK-JAW CENTERLINE CALIPERS

DATA OUTPUT

- Measure hole center distance in the same or offset planes
- Resolution .0005"/0.01mm
- Buttons: on/off, set, inch/mm, preset (+, -)
- Automatic power off, move the digital unit to turn on power
- Battery CR2032
- Data output
- Made of stainless steel
- Optional accessory: data output cable (part no. 7306-20, 7302-SPC5A/SPC5B, 7305-SPC2A, 7305-A01/A02)



1177-300E

Part No.	Range	Accuracy	c	D (DIA)	L1	L2	L
1177-300E	.4-12"/10.5-300mm	±.0039"	.630"	.4"	.709"	1.772"	16.142"
1177-500E	.8-20"/20.5-500mm	±.0039"	.945"	.8"	1.024"	2.756"	27.244"
1177-1000E	1.2-40"/30.5-1000mm	±.0047"	1.220"	1.2"	1.535"	2.756"	48.898"
1177-1500E	1.2-60"/30.5-1500mm	±.0059"	1.220"	1.2"	1.535"	2.756"	68.701"

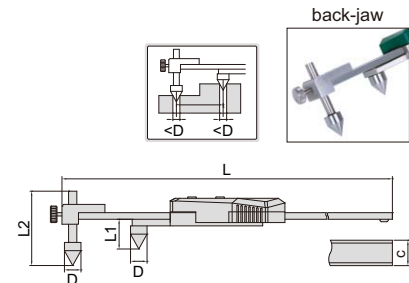

## ELECTRONIC CENTERLINE/EDGE TO CENTER CALIPERS

DATA OUTPUT

- Measure hole center distance or edge to hole center distance
- Resolution .0005"/0.01mm
- Buttons: on/off, set, inch/mm, preset (+, -)
- Automatic power off, move the digital unit to turn on power
- Battery CR2032
- Data output
- Made of stainless steel
- Optional accessory: data output cable (part no. 7306-20, 7302-SPC5A/SPC5B, 7305-SPC2A, 7305-A01/A02)



1525-300E

Part No.	Range of upper jaw (edge to center)	Range of lower jaw (center to center)	Accuracy	c	D (DIA)	L1	L2	L
1525-300E	.2-12"/5.5-300mm	.4-12"/10.5-300mm	±.0031"	.669"	.4"	1.752"	2.165"	16.142"
1525-500E	.4-20"/10.5-500mm	.8-20"/20.5-500mm	±.0035"	.945"	.8"	1.575"	1.969"	27.165"
1525-1000E	.6-40"/15.5-1000mm	1.2-40"/30.5-1000mm	±.0047"	1.220"	1.2"	2.362"	2.756"	49.409"
1525-1500E	.6-60"/15.5-1500mm	1.2-60"/30.5-1500mm	±.0059"	1.220"	1.2"	2.362"	2.756"	69.291"

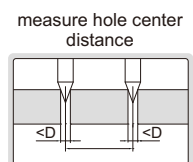
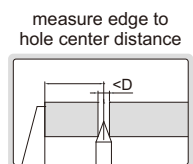
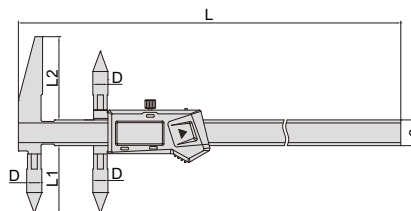

**DATA OUTPUT**

- Measure edge to hole center distance
- Resolution .0005"/0.01mm
- Buttons: on/off, set, inch/mm, preset (+, -)
- Automatic power off, move the digital unit to turn on power
- Battery CR2032, data output
- Made of stainless steel
- Optional accessory: data output cable (part no. **7306-20**, **7302-SPC5A/SPC5B**, **7305-SPC2A**, **7305-A01/A02**)

Part No.	Range	Accuracy
<b>1524-300E</b>	.2-12"/5.5-300mm	±.0039"

preset buttons

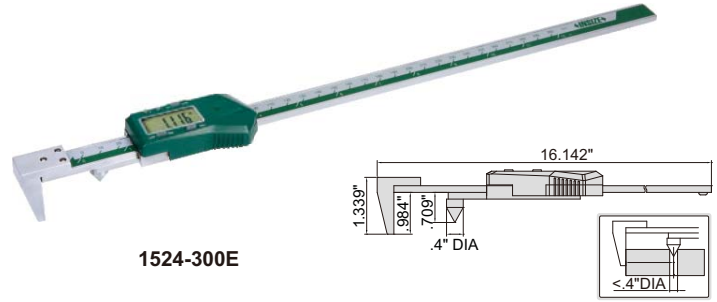

back-jaw

**ELECTRONIC BACK-JAW EDGE TO CENTER CALIPER**

**1524-300E**
**DATA OUTPUT**

- Measure width of groove inside bores
- Resolution .0005"/0.01mm
- Buttons: on/off, zero, inch/mm
- Automatic power off, move the digital unit to turn on power
- Battery CR2032, data output
- Made of stainless steel
- Optional accessory: data output cable (part no. **7306-20**, **7302-SPC5A/SPC5B**, **7305-SPC2A**, **7305-A01/A02**)

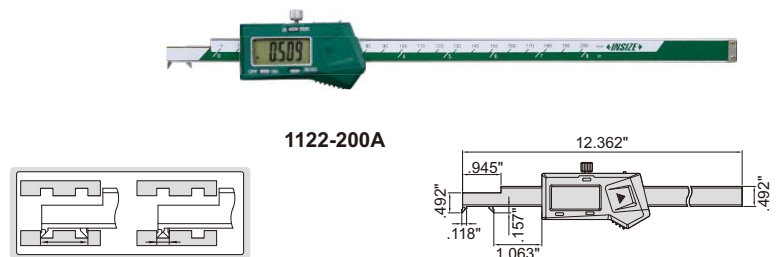
Part No.	Range	Accuracy
<b>1122-200A</b>	.12-8"/3-200mm	±.0012"

**ELECTRONIC HOOK CALIPER**

**1122-200A**
**DATA OUTPUT**

- Measure the radius of arc less than half round
- Resolution .0005"/0.01mm
- Buttons: on/off, zero, inch/mm
- Automatic power off, move the digital unit to turn on power
- Battery CR2032
- Data output
- Made of stainless steel
- Optional accessory: data output cable (part no. **7306-20**, **7302-SPC5A/SPC5B**, **7305-SPC2A**, **7305-A01/A02**)

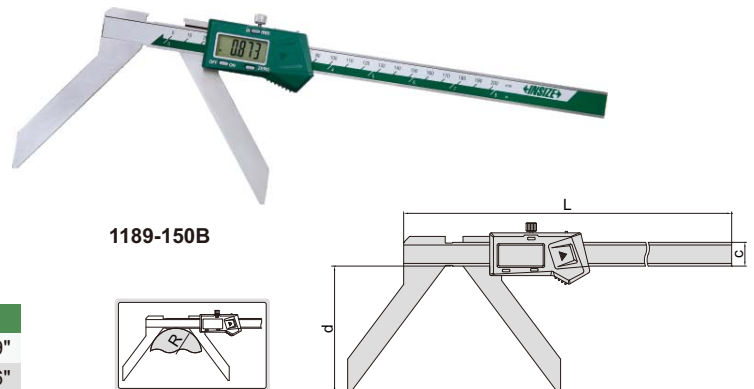
Part No.	Range (R)	Accuracy	L	c	d
<b>1189-150B</b>	.2-6"/5-150mm	±.0020"	10.354"	.630"	2.559"
<b>1189-200B</b>	.2-8"/5-200mm	±.0028"	12.323"	.630"	3.346"

**ELECTRONIC ARC RADIUS CALIPERS**

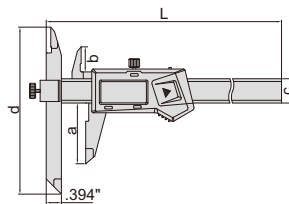
**1189-150B**
**DATA OUTPUT**

- The left jaw can slide up and down to facilitate measurement of stepped sections
- Resolution .0005"/0.01mm
- Buttons: on/off, zero, inch/mm
- Automatic power off, move the digital unit to turn on power
- Battery CR2032, data output
- Made of stainless steel
- Optional accessory: data output cable (part no. **7306-20**, **7302-SPC5A/SPC5B**, **7305-SPC2A**, **7305-A01/A02**)

**ELECTRONIC OFFSET CALIPERS**

**1186-150A**

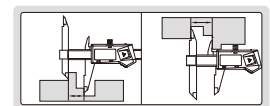
Part No.	Range	Accuracy	L	a	b	c	d
<b>1186-150A</b>	0-6"/0-150mm	±.0016"	9.409"	1.575"	.650"	.669"	4.331"
<b>1186-200A</b>	0-8"/0-200mm	±.0016"	11.378"	1.969"	.768"	.669"	4.724"
<b>1186-300A</b>	0-12"/0-300mm	±.0020"	15.315"	2.362"	.807"	.669"	5.118"





## ELECTRONIC TUBE THICKNESS CALIPER

- Measure wall thickness of tubes
- Resolution .0005"/0.01mm
- Buttons: on/off, zero, inch/mm
- Automatic power off, move the digital unit to turn on power
- Battery CR2032, data output
- Made of stainless steel
- Optional accessory: data output cable (part no. 7306-20, 7302-SPC5A/SPC5B, 7305-SPC2A, 7305-A01/A02)

DATA OUTPUT



1161-150A

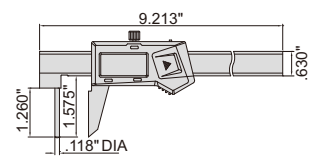
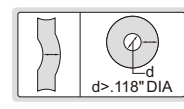

Part No.	Range	Accuracy
1161-150A	0-6"/0-150mm	±.0020"

## ELECTRONIC RTJ RING GROOVE CALIPERS

- Measure ring grooves of flange
- Resolution .0005"/0.01mm
- Button function: on/off, set, zero, inch/mm, data preset
- Battery CR2032, data output
- Made of stainless steel
- Optional accessory: data output cable (part no. 7306-20, 7302-SPC5A/SPC5B, 7305-SPC2A, 7305-A01/A02)

DATA OUTPUT



1179-300

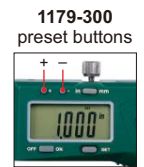

1179-300 preset buttons



1179-600

measure outside diameter of RTJ ring groove

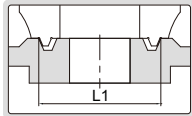

measure inside diameter of RTJ ring groove

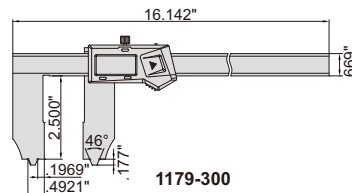
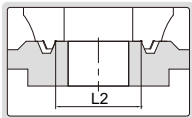

1179-300

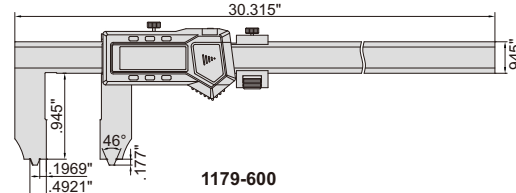

1179-600

applicable for RTJ ring grooves with angle 23°

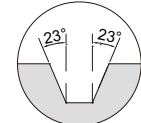

10mm and 25mm need to be added on the reading

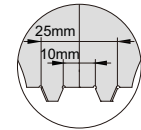

Part No.	Range (inside diameter of RTJ ring groove)	Range (outside diameter of RTJ ring groove)	Angle of RTJ ring groove	Accuracy
1179-300	.4-12"/10-300mm	1-12"/25-300mm	23°	±.0024"
1179-600	.4-24"/10-600mm	1-24"/25-600mm	23°	±.0028"

## ELECTRONIC CALIPER WITH INTERCHANGEABLE BALL TIPS

DATA OUTPUT

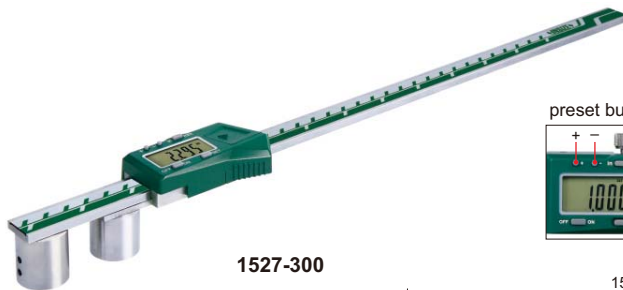

1527-300



ball tips (included, supplied in pair)



1/16" DIA

1/4" DIA

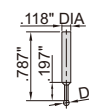

type A

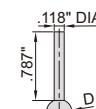

type B

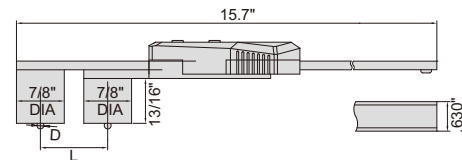

- Supplied with 6 pairs of ball tips
- Resolution .0005"/0.01mm
- Buttons: on/off, set, mm/inch, preset (+, -)
- Automatic power off, move the digital unit to turn on power
- Battery CR2032, data output
- Made of stainless steel
- Optional accessory: data output cable (part no. 7306-20A, 7302-SPC5A/SPC5B, 7305-SPC2A, 7305-A01/A02)

Part No.	Range	Accuracy
1527-300	(7/8"+D)~12" *	±.0012"

\*"D" is the diameter of ball tips.

Diameter (D)	Accuracy of diameter	Type	Material
1/16" DIA	.0002"	A	Ruby
1/8" DIA	.0002"	B	Stainless steel
3/16" DIA	.0002"	B	Stainless steel
1/4" DIA	.0002"	B	Stainless steel
3/8" DIA	.0002"	B	Stainless steel
1/2" DIA	.0002"	B	Stainless steel

DATA  
OUTPUT

## ELECTRONIC CALIPER WITH INTERCHANGEABLE BALL TIPS

2



1528-300

ball tips (included, supplied in pair)



preset buttons

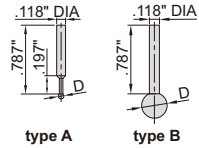
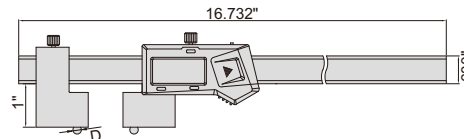

- Supplied with 6 pairs of ball tips
- Resolution .0005"/0.01mm
- Buttons: on/off, set, mm/inch, preset (+, -)
- Automatic power off, move the digital unit to turn on power
- Battery CR2032, data output
- Made of stainless steel
- Optional accessory: data output cable (part no. 7306-20, 7302-SPC5A/SPC5B, 7305-SPC2A, 7305-A01/A02)

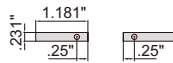

Part No.	Range	Accuracy
1528-300	(.5"+D)~12" *	±.0012"

\*"D" is the diameter of ball tips.

Diameter (D)	Accuracy of diameter	Type	Material
1/16" DIA	.0002"	A	Ruby
1/8" DIA	.0002"	B	Stainless steel
3/16" DIA	.0002"	B	Stainless steel
1/4" DIA	.0002"	B	Stainless steel
3/8" DIA	.0002"	B	Stainless steel
1/2" DIA	.0002"	B	Stainless steel

RELATIVE PRODUCT: CRIMP HEIGHT  
MICROMETER (PART NO. 3266-1B, 3566-25BE)

DATA  
OUTPUT

## ELECTRONIC CRIMP HEIGHT CALIPER

- Measure crimp height
- Resolution .0005"/0.01mm
- Buttons: on/off, zero, inch/mm
- Automatic power off, move the digital unit to turn on power
- Battery CR2032, data output
- Made of stainless steel
- Optional accessory: data output cable (part no. 7306-20, 7302-SPC5A/SPC5B, 7305-SPC2A, 7305-A01/A02)



1165-150A

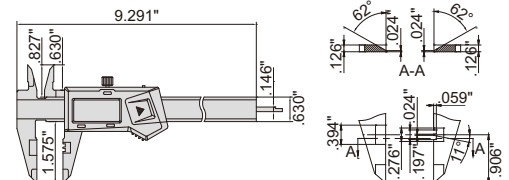

Part No.	Range	Accuracy
1165-150A	0-6"/0-150mm	±.0012"

DATA  
OUTPUT

## ELECTRONIC CALIPER WITH LARGE MEASURING FACES

- Measure diameter of wire ropes, and thickness of soft materials like rubber, sponge, etc.
- Resolution .0005"/0.01mm
- Buttons: on/off, zero, inch/mm
- Automatic power off, move the digital unit to turn on power
- Battery CR2032, data output
- Made of stainless steel
- Optional accessory: data output cable (part no. 7306-20, 7302-SPC5A/SPC5B, 7305-SPC2A, 7305-A01/A02)



1172-200

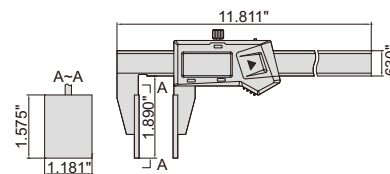

measure diameter of wire ropes

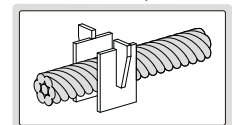

measure thickness of rubber, sponge, etc.

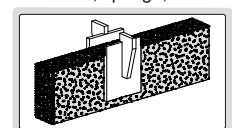

Part No.	Range	Accuracy
1172-200	0-8"/0-200mm	±.0028"

## ELECTRONIC GEAR TOOTH CALIPERS

ATTENTION:  
NO DATA OUTPUT

- Resolution .0005"/0.01mm
- Carbide tips
- Buttons: zero, on/off, inch/mm
- Automatic power off, move the digital unit to turn on power
- Battery CR2032
- Made of stainless steel

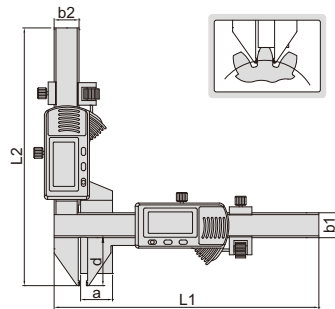

1181-M25A

Part No.	Range	Accuracy	L1	L2	a	b1	b2	d
1181-M25A	P1-P24	±.0016"	6.693"	6.516"	.827"	.630"	.630"	1.201"
1181-M50A	P1/2-P5	±.0016"	8.661"	7.480"	1.988"	.630"	.630"	2.165"

## ELECTRONIC DISK BRAKE CALIPER

RELATIVE PRODUCT: DISK BRAKE  
MICROMETER (PART NO. 3288-, 3588-)

DATA  
OUTPUT

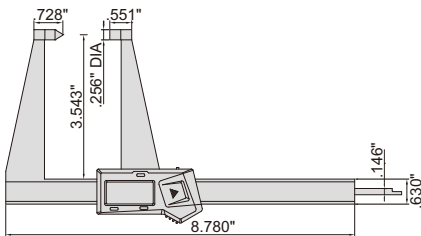

1162-125A



- Measure thickness of disk brakes
- Resolution .0005"/0.01mm
- Buttons: on/off, zero, inch/mm
- Automatic power off, move the digital unit to turn on power
- Battery CR2032, data output
- Made of stainless steel
- Optional accessory: data output cable (part no. 7306-20, 7302-SPC5A/SPC5B, 7305-SPC2A, 7305-A01/A02)

Part No.	Range	Accuracy
1162-125A	0-5"/0-125mm	±.0020"

## ELECTRONIC DISK BRAKE AND PAD CALIPER

RELATIVE PRODUCT: DISK BRAKE  
MICROMETER (PART NO. 3288-, 3588-)

DATA  
OUTPUT

- Measure thickness of disk brakes and pad wear
- Resolution .0005"/0.01mm
- Buttons: on/off, zero, inch/mm
- Automatic power off, move the digital unit to turn on power
- Battery CR2032
- Data output
- Made of stainless steel
- Optional accessory: data output cable (part no. 7306-20, 7302-SPC5A/SPC5B, 7305-SPC2A, 7305-A01/A02)

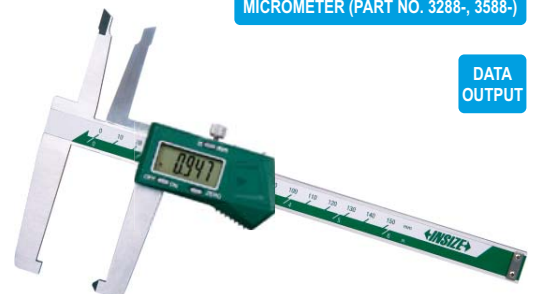
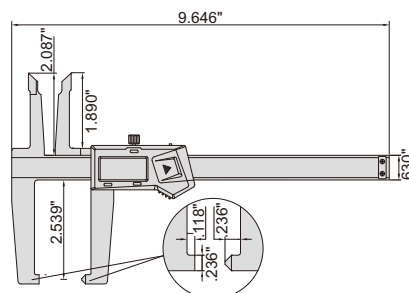

1167-150A

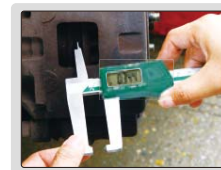

Part No.	Range	Accuracy
1167-150A	0-6"/0-150mm	±.0028"

RELATIVE PRODUCT: DISK BRAKE MICROMETER (PART NO. 3288-, 3588-)

DATA OUTPUT

- Measure internal and external diameter of drum brakes
- Resolution .0005"/0.01mm
- Buttons: on/off, zero, inch/mm
- Automatic power off, move the digital unit to turn on power
- Battery CR2032
- Data output
- Made of stainless steel
- Optional accessory: data output cable (part no. 7306-20, 7302-SPC5A/SPC5B, 7305-SPC2A, 7305-A01/A02)



Part No.	Range	Accuracy
1168-300A	0-12"/0-300mm	±.0028"

## ELECTRONIC DRUM BRAKE CALIPER



1168-300A

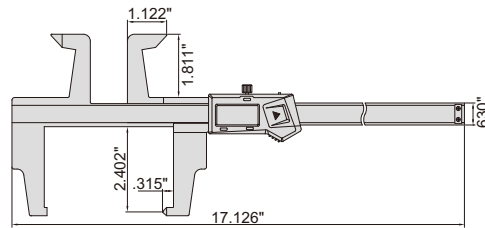

ATTENTION: NO DATA OUTPUT

ATTENTION: IT IS NECESSARY TO SET ZERO AFTER POWER ON EACH TIME

IP67 WATERPROOF

- Ip67 dust/waterproof
- Resolution .0005"/0.01mm
- Button function: zero, on/off, inch/mm, ABS/REL, hold
- Meet DIN862
- Battery CR2032
- Made of stainless steel

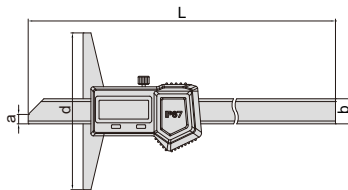

## ELECTRONIC WATERPROOF DEPTH GAGES



1149-150

Part No.	Range	Accuracy	L	a	b	d
1149-150	0-6"/0-150mm	±.0012"	9.449"	.236"	.630"	3.937"
1149-200	0-8"/0-200mm	±.0012"	11.417"	.236"	.630"	3.937"
1149-300	0-12"/0-300mm	±.0012"	15.354"	.236"	.630"	5.906"

DATA OUTPUT

## ELECTRONIC DEPTH GAGES (STANDARD MODEL)

- Resolution .0005"/0.01mm
- Buttons: on/off, zero, inch/mm
- Automatic power off, move the digital unit to turn on power
- Battery CR2032, data output
- Made of stainless steel
- Optional accessory: data output cable (part no. 7306-20, 7302-SPC5A/SPC5B, 7305-SPC2A, 7305-A01/A02)



1141-150A

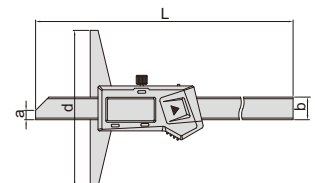

Part No.	Range	Accuracy	L	a	b	d
1141-150A	0-6"/0-150mm	±.0012"	9.055"	.236"	.571"	3.937"
1141-200A	0-8"/0-200mm	±.0012"	11.024"	.236"	.571"	3.937"
1141-300A	0-12"/0-300mm	±.0012"	14.961"	.236"	.571"	5.906"
1141-500A	0-20"/0-500mm	±.0020"	23.031"	.276"	.591"	5.906"



## ELECTRONIC DEPTH GAGES WITH MOUNTING HOLES FOR EXTENSION BASE

DATA  
OUTPUT

3

- Resolution .0005"/0.01mm
- Buttons: on/off, zero, inch/mm
- Automatic power off, move the digital unit to turn on power
- Battery CR2032
- Data output
- Made of stainless steel
- Optional accessory: data output cable (part no. 7306-20, 7302-SPC5A/SPC5B, 7305-SPC2A, 7305-A01/A02), extension base (part no. 6141)



1147-300

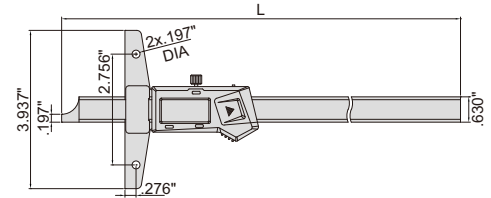

Part No.	Range	Accuracy	L
1147-150	0-6"/0-150mm	±.0012"	9.331"
1147-200	0-8"/0-200mm	±.0012"	11.299"
1147-300	0-12"/0-300mm	±.0012"	15.866"

## ELECTRONIC POINT DEPTH GAGE

DATA  
OUTPUT

- Resolution .0005"/0.01mm
- Buttons: on/off, zero, inch/mm
- Automatic power off, move the digital unit to turn on power
- Battery CR2032
- Data output
- Made of stainless steel
- Optional accessory: data output cable (part no. 7306-20, 7302-SPC5A/SPC5B, 7305-SPC2A, 7305-A01/A02)



1143-200A

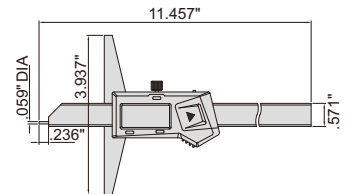
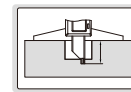

Part No.	Range	Accuracy
1143-200A	0-8"/0-200mm	±.0012"

## ELECTRONIC HOOK DEPTH GAGES

DATA  
OUTPUT

- Resolution .0005"/0.01mm
- Buttons: on/off, zero, inch/mm
- Automatic power off, move the digital unit to turn on power
- Battery CR2032
- Data output
- Made of stainless steel
- Optional accessory: data output cable (part no. 7306-20, 7302-SPC5A/SPC5B, 7305-SPC2A, 7305-A01/A02)



1142-150A

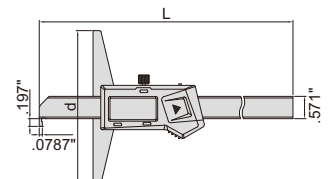
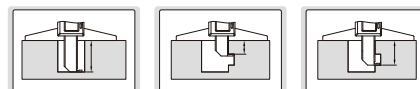

Part No.	Range	Accuracy	L	d
1142-150A	0-6"/0-150mm	±.0012"	9.055"	3.937"
1142-200A	0-8"/0-200mm	±.0012"	11.024"	3.937"
1142-300A	0-12"/0-300mm	±.0016"	14.961"	5.906"

**DATA OUTPUT**

- Resolution .0005"/0.01mm
- Buttons: on/off, zero, inch/mm
- Automatic power off, move the digital unit to turn on power
- Battery CR2032
- Data output
- Made of stainless steel
- Optional accessory: data output cable (part no. **7306-20**, **7302-SPC5A/SPC5B**, **7305-SPC2A**, **7305-A01/A02**)

Part No.	Range	Accuracy	L	d
<b>1144-150A</b>	0-6"/0-150mm	±.0012"	9.173"	3.937"
<b>1144-200A</b>	0-8"/0-200mm	±.0012"	11.142"	3.937"
<b>1144-300A</b>	0-12"/0-300mm	±.0012"	15.079"	5.906"

**ELECTRONIC DOUBLE HOOK DEPTH GAGES**

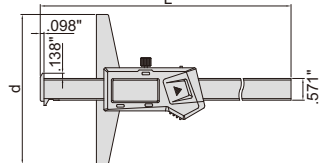
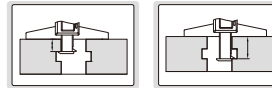
**1144-150A**

**MEASURE WIDTH AND DEPTH OF GROOVES INSIDE BORE**
**DATA OUTPUT**
**MEASURE DEPTH OF SMALL HOLES (>.157"DIA)**

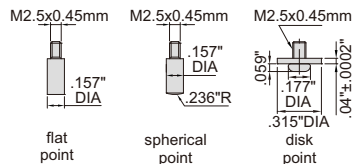
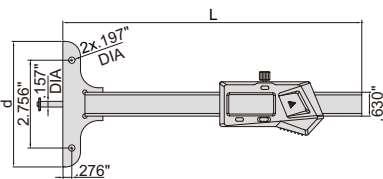
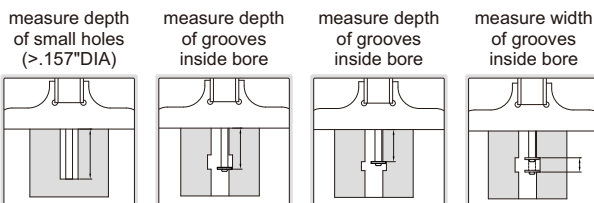
- Resolution .0005"/0.01mm
- Supplied with three interchangeable points (flat, spherical, disk)
- Buttons: on/off, set, inch/mm, preset (+, -)
- Automatic power off, move the digital unit to turn on power
- Battery CR2032, data output
- Made of stainless steel
- Optional accessory: data output cable (part no. **7306-20**, **7302-SPC5A/SPC5B**, **7305-SPC2A**, **7305-A01/A02**), disk points (see below table), extension base (part no. **6141**, for **1148-120E**, **1148-200E** and **1148-300E**)

 one-hand use of **1148-120E**

 extension base for **1148-120E**, **1148-200E** and **1148-300E** (optional)

Part No.	Range*	Accuracy	L	d	Remark
<b>1148-100SE</b>	0-4"/0-100mm	±.0008"	7.874"	1.772"	
<b>1148-100E</b>	0-4"/0-100mm	±.0008"	7.874"	3.346"	
<b>1148-120E</b>	0-4.7"/0-120mm	±.0012"	11.811"	3.976"	one-hand use, with mounting holes for extension base
<b>1148-200E</b>	0-8"/0-200mm	±.0012"	11.811"	3.976"	with mounting holes for extension base
<b>1148-300E</b>	0-12"/0-300mm	±.0012"	15.748"	3.976"	with mounting holes for extension base

\* When disk points are used, the range is reduced by .394"

**OPTIONAL DISK POINT**

Part No.	Description	Remark
<b>1148-P103E</b>	.04" disk point	for grooves inside blind hole

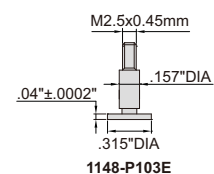
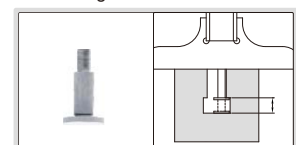
**1148-P103E** (optional), measure width of bottom grooves inside blind hole

## EXTENSION BASES

3

- Supplied with two screws
- Made of stainless steel
- Suitable for depth gages series 1147 and 1148

Part No.	Length
6141-180	7.087"
6141-260	10.236"
6141-320	12.598"

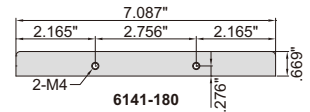

6141-260

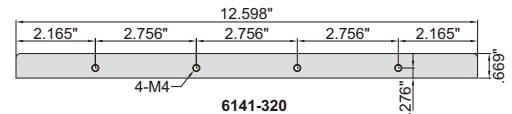
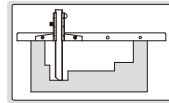
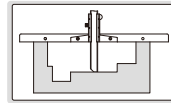
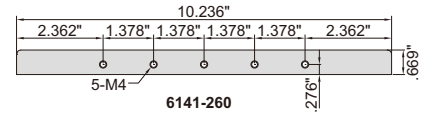

## MINI ELECTRONIC DEPTH GAGE

DATA OUTPUT

- Measure depth of small groove and hole, also measure depth of tire tread
- Resolution .0005"/0.01mm
- Buttons: on/off, zero, inch/mm
- Supplied with zero set surface
- Automatic power off, move the digital unit to turn on power
- Battery CR2032
- Data output
- Made of stainless steel
- Optional accessory: data output cable (part no. 7306-20, 7302-SPC5A/SPC5B, 7305-SPC2A, 7305-A01/A02)

Part No.	Range	Accuracy
1145-25A	0-1"/0-25mm	±.0012"



1145-25A

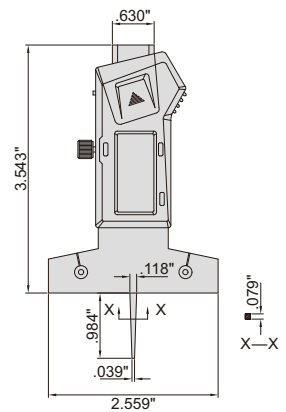

## MINI ELECTRONIC DEPTH GAGES WITH ROUND BAR

DATA OUTPUT

- Measure depth of small groove and hole
- Resolution .0005"/0.01mm
- Buttons: on/off, set, inch/mm, preset (+,-)
- Automatic power off, move the digital unit to turn on power
- Battery CR2032
- Data output
- Made of stainless steel
- Optional accessory: data output cable (part no. 7306-20, 7302-SPC5A/SPC5B, 7305-SPC2A, 7305-A01/A02)

Part No.	Range	Accuracy	L
1140-25	0-1"/0-25mm	±.0008"	4.488"
1140-50	0-2"/0-50mm	±.0008"	5.512"



1140-25

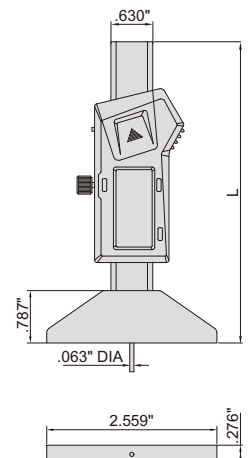

**DATA OUTPUT**

**ELECTRONIC DEPTH GAGES**

- Button function: on/off, zero, inch/mm, ABS, data preset, change measuring direction
- CR2032 battery, automatic power off
- Data output
- Stainless steel base
- Pointed tip
- Optional accessory: data output cable (part no. 7306-40, 7302-SPC3A, 7305-SPC1A, 7305-C01)

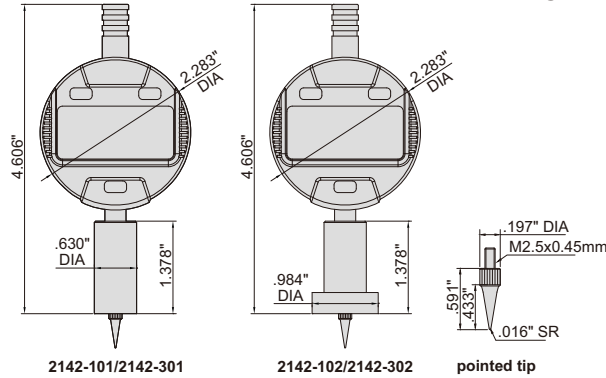

2142-102

Part No.	Range	Digital indicator stroke	Digital indicator resolution	Accuracy	Base
2142-101	0-.5"/0-12.7mm	.5"/12.7mm	.0005"/0.01mm	±.0008"	.630" DIA
2142-102	0-.5"/0-12.7mm	.5"/12.7mm	.0005"/0.01mm	±.0008"	.984" DIA
2142-301	0-.5"/0-12.7mm	.5"/12.7mm	.00005"/0.001mm	±.0002"	.630" DIA
2142-302	0-.5"/0-12.7mm	.5"/12.7mm	.00005"/0.001mm	±.0002"	.984" DIA

- Stainless steel base
- Supplied with pointed tip and ball tip

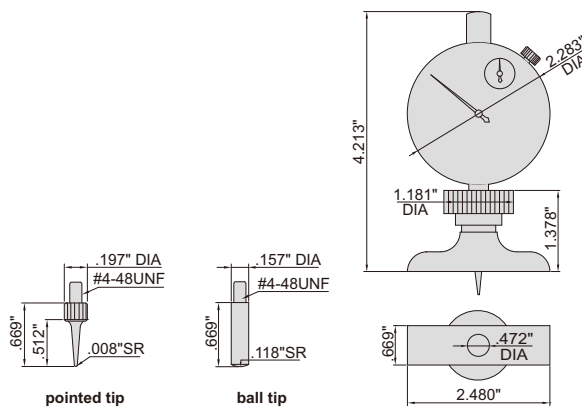

**DIAL DEPTH GAGE**



2341-E1

Part No.	Range	Dial indicator stroke	Dial indicator graduation	Accuracy
2341-E1	0-1.2"	.5"	.001"	±.0012"

**DIAL DEPTH GAGE WITH 60° BASE**

- Dial indicator graduation .001"
- Stainless steel base

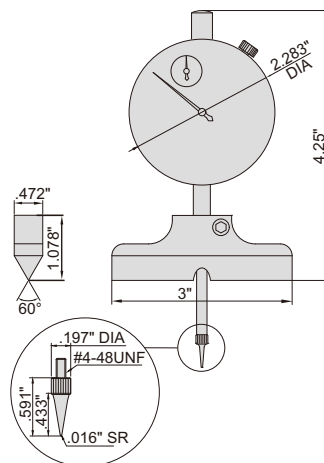

front view

2345-E1

side view

Part No.	Range	Accuracy
2345-E1	0-1"	±.002"



## DIAL DEPTH GAGES

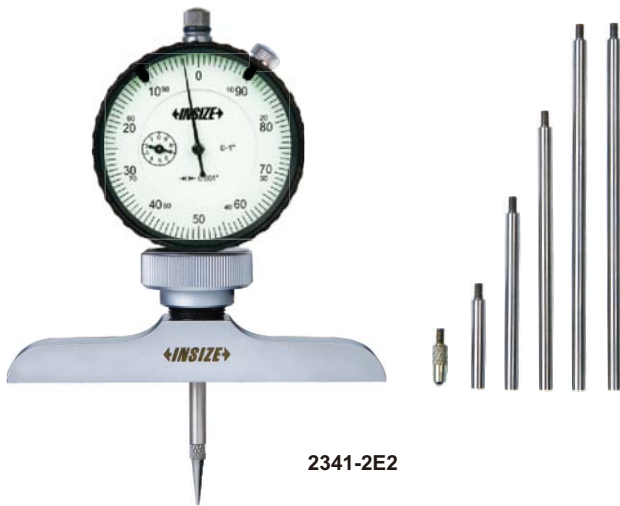

2341-2E2

- Dial indicator graduation .001"
- Accuracy:  $\pm .002$ "
- Stainless steel base
- Extension rods: 1" (1 pc), 2" (1 pc), 3" (1 pc), 4" (2 pcs)
- Supplied with pointed tip and ball tip

Part No.	Range	Dial indicator stroke	Base
2341-2E1	0-12"	1"	2.480 x .669"
2341-2E2	0-12"	1"	3.996 x .669"

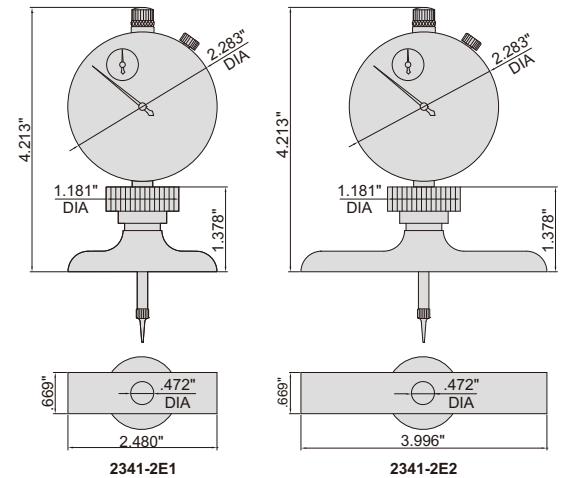

2341-2E1

2341-2E2

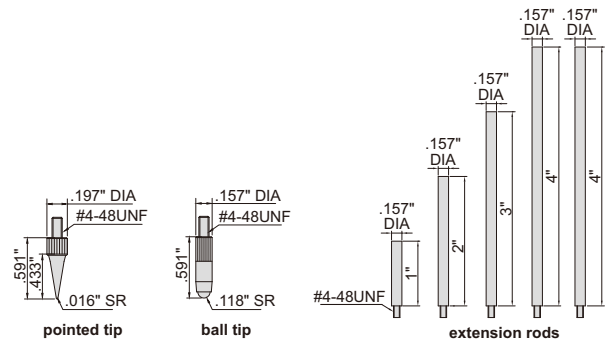

pointed tip

ball tip

extension rods

## ELECTRONIC DEPTH GAGES

DATA OUTPUT



2141-202A

- Button function: on/off, zero, inch/mm, ABS, data preset, change measuring direction
- CR2032 battery, automatic power off
- Data output
- Stainless steel base
- Supplied with pointed tip and ball tip
- Optional accessory: data output cable (part no. 7306-40, 7302-SPC3A, 7305-SPC1A, 7305-C01)

Part No.	Range	Digital indicator stroke	Digital indicator resolution	Accuracy	Base
2141-201A	0-12"/0-300mm	.5"/12.7mm	.0005"/0.01mm	$\pm .0008$ "	2.480 x .669"
2141-202A	0-12"/0-300mm	.5"/12.7mm	.0005"/0.01mm	$\pm .0008$ "	3.996 x .669"
2141-301	0-12"/0-300mm	.5"/12.7mm	.00005"/0.001mm	$\pm .0002$ "	2.480 x .669"
2141-302	0-12"/0-300mm	.5"/12.7mm	.00005"/0.001mm	$\pm .0002$ "	3.996 x .669"

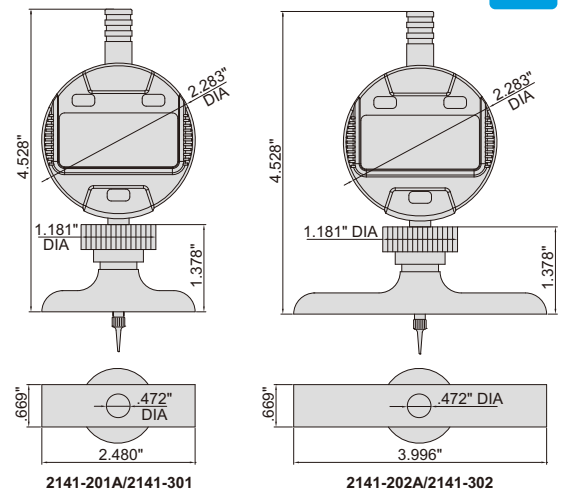

2141-201A/2141-301

2141-202A/2141-302

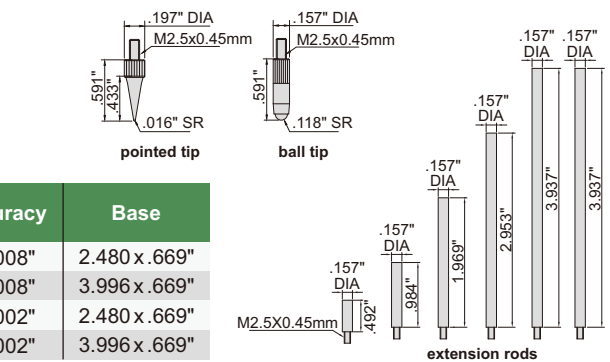

pointed tip

ball tip

extension rods

**IP65**  
WATERPROOF

**DATA**  
OUTPUT

## ELECTRONIC DEPTH MICROMETERS

- Resolution .0005"/0.01mm
- Micrometer head accuracy:  $\pm 0.00012"$
- Rod accuracy:  $\pm [0.001 + 0.0005(L/3)]"$ , L is the measuring range in inch
- Button function: on/off, set, inch/mm, ABS/INC
- IP65 dust/waterproof
- Data output
- LR44 battery, automatic power off
- Rods with flat end
- Ratchet stop
- Optional accessory: data output cable (part no. **7306-30A**, **7302-SPC6**, **7305-SPC3A**, **7305-B01**)

Part No.	Range	Rods
<b>3540-50E</b>	0-2"/0-50mm	2 pcs
<b>3540-150E</b>	0-6"/0-150mm	6 pcs
<b>3540-300E</b>	0-12"/0-300mm	12 pcs



**3540-150E**

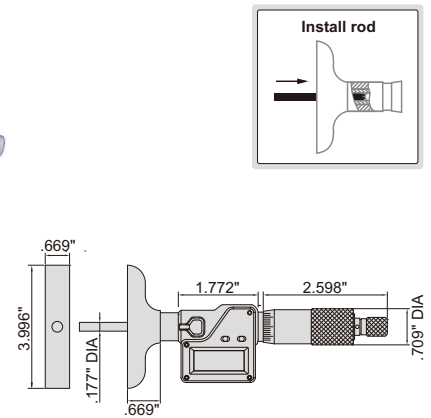

3

## DEPTH MICROMETERS

- Graduation .001"
- Micrometer head accuracy:  $\pm 0.00012"$
- Rod accuracy:  $\pm [0.001 + 0.0005(L/3)]"$ , L is the measuring range in inch
- Rods with flat end
- Ratchet stop

Part No.	Range	Rods
<b>3240-1</b>	0-1"	1 pc
<b>3240-4</b>	0-4"	2 pcs
<b>3240-6</b>	0-6"	6 pcs



**3240-6**

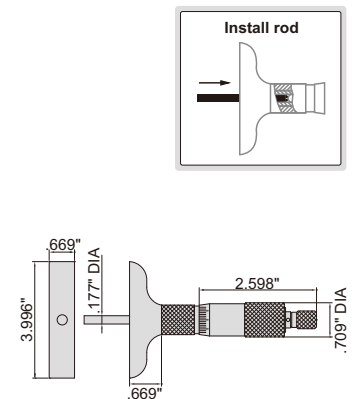

## DEPTH MICROMETERS

- Graduation .001"
- Micrometer head accuracy:  $\pm 0.00012"$
- Rod accuracy:  $\pm [0.001 + 0.0005(L/3)]"$ , L is the measuring range in inch
- Rods with flat end
- Ratchet stop

Base: HxW=3.996x.669"

Part No.	Range	Rods
<b>3241-1</b>	0-1"	1 pc
<b>3241-2</b>	0-2"	2 pcs
<b>3241-3</b>	0-3"	3 pcs
<b>3241-4</b>	0-4"	4 pcs
<b>3241-6</b>	0-6"	6 pcs
<b>3241-8</b>	0-8"	8 pcs
<b>3241-12</b>	0-12"	12 pcs



**3241-4**

Base: HxW=2.480x.669"

Part No.	Range	Rods
<b>3241-B1</b>	0-1"	1 pc
<b>3241-B4</b>	0-4"	4 pcs

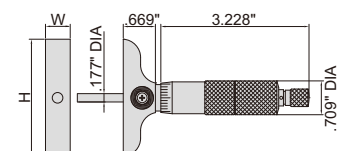
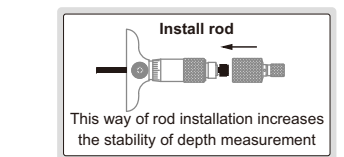

## ELECTRONIC HEIGHT GAGES (ECONOMIC MODEL)

- Resolution .0005"/0.01mm
- Buttons: on/off, zero, inch/mm, ABS/INC, data hold, TOL, set
- ABS/INC is for absolute and incremental measurement
- TOL is for tolerance measurement
- Carbide tipped scriber
- Made of stainless steel (except the base)
- LR44 battery, data output
- Supplied with dial test indicator holder
- Supplied with dust cover (except 1150-1500E/2000E)
- Optional accessory: data output cable (part no. 7301-SPC5)

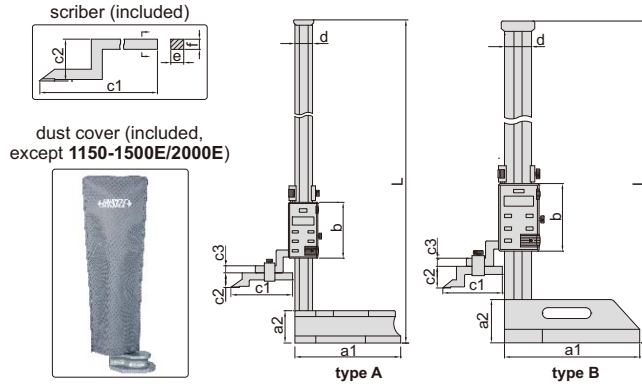

dial test indicator holder (included)

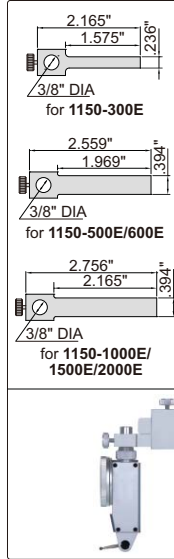

ATTENTION: LOW ACCURACY

ATTENTION: CAN NOT USE CLAMP FOR PROTRACTORS (PART NO.2372-CLAMP)

DATA OUTPUT



1150-500E

1150-1000E

Part No.	Range	Type	Accuracy	L	a1	a2	b	c1	c2	c3	d	e	f
1150-300E	0-12"/0-300mm	A	±.0020"	18.504"	5.315"	1.772"	3.150"	2.992"	.984"	.394"	.906"	.236"	.315"
1150-500E	0-20"/0-500mm	A	±.0024"	28.346"	7.087"	2.165"	3.740"	4.055"	.984"	.472"	1.181"	.394"	.472"
1150-600E	0-24"/0-600mm	B	±.0024"	32.283"	7.087"	2.165"	3.740"	4.055"	.984"	.472"	1.181"	.394"	.472"
1150-1000E	0-40"/0-1000mm	B	±.0031"	50.197"	9.843"	3.150"	4.921"	4.331"	1.535"	.591"	1.969"	.394"	.591"
1150-1500E	0-60"/0-1500mm	B	±.0047"	70.472"	11.024"	3.150"	4.921"	4.331"	1.535"	.591"	1.969"	.394"	.591"
1150-2000E	0-80"/0-2000mm	B	±.0063"	90.157"	11.024"	3.150"	4.921"	4.331"	1.535"	.591"	1.969"	.394"	.591"

## ELECTRONIC HEIGHT GAGES WITH DRIVING WHEEL

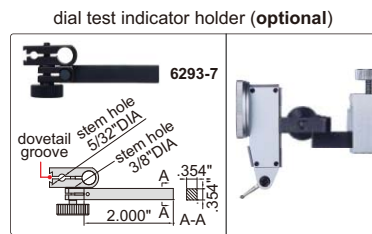

DATA OUTPUT



- Resolution .0005"/0.01mm
- Buttons: on/off, zero, inch/mm, preset (+, -), hold
- Automatic power off, move the digital unit to turn on power
- Carbide tipped scriber
- Made of stainless steel
- Battery CR2032, data output
- Supplied with dust cover
- Optional accessory: data output cable (part no. 7306-20, 7302-SPC5A/SPC5B, 7305-SPC2A, 7305-A01/A02), dial test indicator holder (part no. 6293-7), clamp for protractors (part no. 2372-CLAMP)

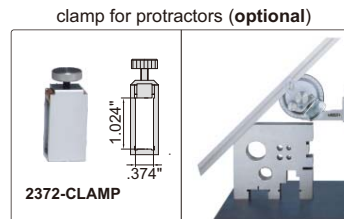
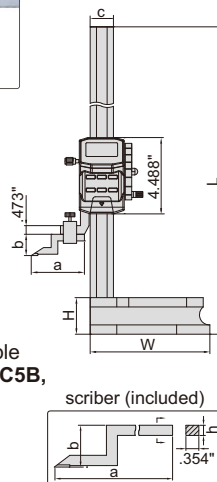

1156-300

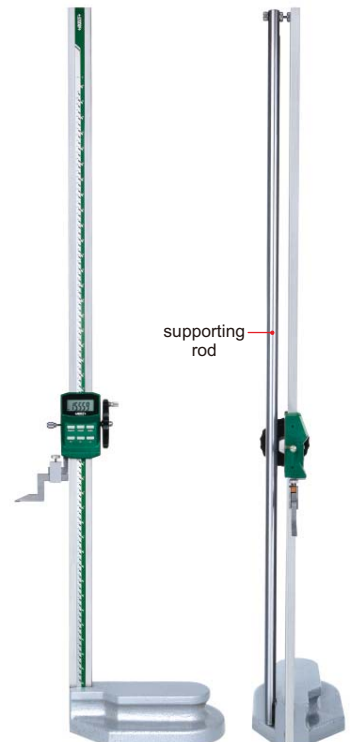

front

side

1156-1000

Part No.	Range	Accuracy	L	W	H	a	b	c	h
1156-300	0-12"/0-300mm	±.0012"	20.276"	7.087"	2.165"	3.150"	1.181"	1.378"	.354"
1156-600	0-24"/0-600mm	±.0020"	32.087"	7.087"	2.165"	3.150"	1.181"	1.378"	.354"
1156-1000	0-40"/0-1000mm	±.0028"	48.031"	10.433"	2.756"	3.622"	1.890"	1.575"	.472"

DATA OUTPUT

ATTENTION: CAN NOT USE CLAMP FOR PROTRACTORS (PART NO. 2372-CLAMP)

## ELECTRONIC HEIGHT GAGE (LIGHT DUTY)

- Resolution .0005"/0.01mm
- Buttons: on/off, zero, inch/mm
- Automatic power off, move the digital unit to turn on power
- Carbide tipped scriber
- With fine adjustment
- Made of stainless steel
- Battery CR2032, data output
- Optional accessory: data output cable (part no. 7306-20, 7302-SPC5A/SPC5B, 7305-SPC2A, 7305-A01/A02), dial test indicator holder (part no. 7151-CL2)

Part No.	Range	Accuracy
1154-150	0-6"/0-150mm	±.0012"

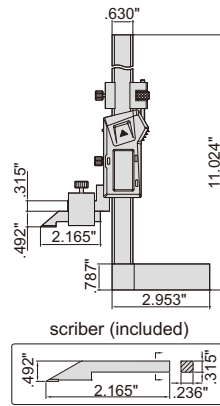

1154-150

dial test indicator holder (optional)

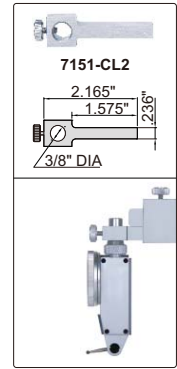

driving wheel on the back

- Dial indicator graduation .001"
- One counter reads in the plus direction and another in the minus direction, so incremental measurement can be made in either direction
- Carbide tipped scriber
- Made of stainless steel (except the base)
- With driving wheel
- Supplied with dust cover
- Optional accessory: dial test indicator holder (part no. 6293-7), clamp for protractors (part no. 2372-CLAMP)

dust cover (included)

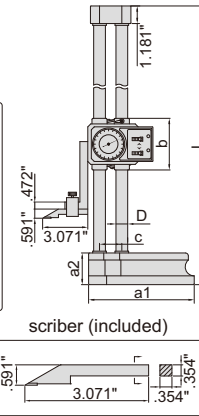

1351-12

## DIAL HEIGHT GAGES

dial test indicator holder (optional)

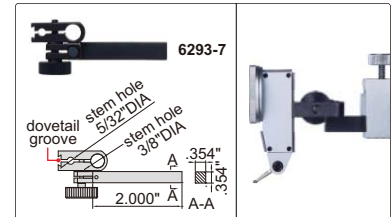

clamp for protractors (optional)

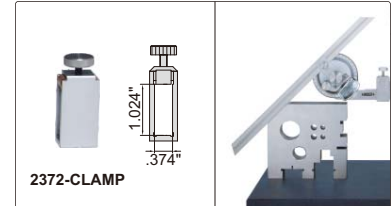

Part No.	Range	Accuracy	L	a1	a2	b	c	D
1351-12	0-12"	±.0016"	18.701"	5.315"	1.693"	3.307"	1.299"	.591" DIA
1351-18	0-18"	±.0020"	25.984"	7.087"	2.126"	3.465"	1.496"	.787" DIA
1351-24	0-24"	±.0020"	31.890"	7.087"	2.126"	3.465"	1.496"	.787" DIA

scriber (included)

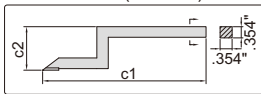

- Graduation .001"/0.02mm
- Adjustable main scale to set zero
- Carbide tipped scriber
- Made of stainless steel (except the base)
- Satin chrome plated scale
- Supplied with magnifier
- With fine adjustment
- Supplied with dust cover
- Optional accessory: dial test indicator holder (part no. 6293-7), clamp for protractors (part no. 2372-CLAMP)

dust cover (included)

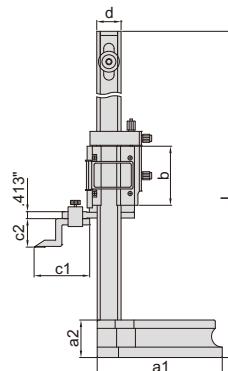

1250-300

dial test indicator holder (optional)

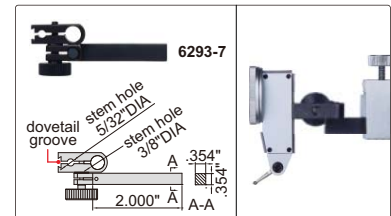

clamp for protractors (optional)

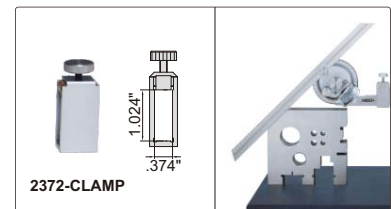

Part No.	Range	Accuracy	L	a1	a2	b	c1	c2	d
1250-300	0-12"/0-300mm	±.0016"	21.457"	5.315"	1.693"	2.953"	3.150"	1.181"	1.102"
1250-450	0-18"/0-450mm	±.0020"	28.346"	7.087"	2.126"	3.346"	3.150"	1.614"	1.378"
1250-600	0-24"/0-600mm	±.0020"	34.252"	7.087"	2.126"	3.346"	3.150"	1.614"	1.378"



## VERNIER HEIGHT GAGES (LIGHT DUTY)

ATTENTION: CAN NOT USE CLAMP FOR PROTRACTORS (PART NO. 2372-CLAMP)

- Graduation .001"/0.02mm
- Carbide tipped scriber
- Made of stainless steel (except the base)
- Satin chrome plated scale
- Optional accessory: dial test indicator holder (part no. **7151-CL2**)
- Supplied in fitted storage case

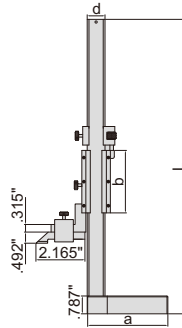
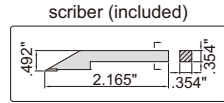

1253-200

dial test indicator holder (optional)

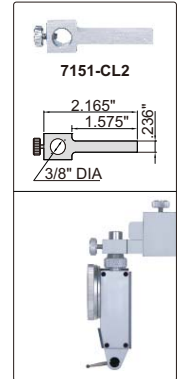

Part No.	Range	Accuracy	L	a	b	d
1253-150	0-6"/0-150mm	±.0012"	10.433"	2.953"	2.244"	.630"
1253-200	0-8"/0-200mm	±.0012"	12.795"	3.543"	2.756"	.787"

## MINI ELECTRONIC HEIGHT GAGES

DATA OUTPUT

application of 1146-20A

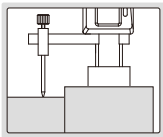

application of 1146-20B

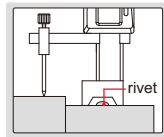

- Measure height difference of two surfaces (1146-20B suitable for surfaces with barrier, such as rivet)
- Resolution .0005"/0.01mm
- Buttons: on/off, zero, inch/mm
- Automatic power off, move the digital unit to turn on power
- Battery CR2032, data output
- Made of stainless steel
- Optional accessory: data output cable (part no. **7306-20**, **7302-SPC5A/SPC5B**, **7305-SPC2A**, **7305-A01/A02**)



1146-20A



1146-20B

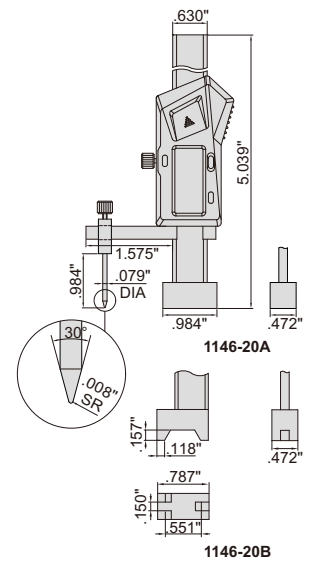

Part No.	Range	Accuracy
1146-20A	0-.8"/0-20mm	±.0008"
1146-20B	0-.8"/0-20mm	±.0008"

## SCRIBERS FOR HEIGHT GAGES

- Carbide tipped



7150-SC1

Part No.	For height gages	Type	c1	c2	D	E
7150-SC1	1150-300E	A	2.992"	.984"	.236"	.315"
7150-SC2	1150-500E, 1150-600E	A	4.055"	.984"	.394"	.472"
7150-SC3	1150-1000E, 1150-1500E, 1150-2000E	A	4.331"	1.535"	.394"	.591"
7150-SC4	1351-12, 1351-18, 1351-24	B	3.071"	.591"	.354"	.354"
7150-SC6	1250-300, 1156-300, 1156-600	A	3.150"	1.181"	.354"	.354"
7150-SC7	1250-450, 1250-600	A	3.150"	1.614"	.354"	.354"
7150-SC9	1253-150, 1253-200, 1154-150	B	2.165"	.492"	.236"	.315"
7150-SC10	1156-1000	A	3.622"	1.890"	.354"	.472"

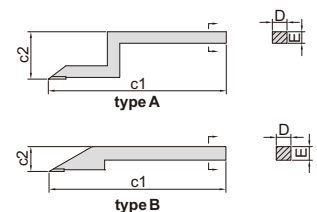



DATA OUTPUT

IP65 WATERPROOF

## ELECTRONIC OUTSIDE MICROMETERS (WITH DATA OUTPUT)

- Resolution .00005"/0.001mm (resolution of 3101-275E and 3101-300E is .0001"/0.001mm)
- IP65 dust/waterproof
- Button function: on/off, set, inch/mm, ABS/INC
- Data output
- LR44 battery, automatic power off
- Carbide measuring faces
- Supplied with spherical anvil
- Setting standards are included (except 0-1"/0-25mm)
- Optional accessory: data output cable (part no. 7306-30A, 7302-SPC6, 7305-SPC3A, 7305-B01)



3101-25E

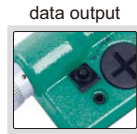

### Individual (ratchet stop type)

Part No.	Range	Accuracy	L	a	b	c
3101-25E*	0-1"/0-25mm	±.00008"	1.358"	.236"	.984"	.118"
3101-50E*	1-2"/25-50mm	±.00008"	2.343"	.315"	1.260"	.118"
3101-75E*	2-3"/50-75mm	±.00012"	3.327"	.315"	1.752"	.118"
3101-100E*	3-4"/75-100mm	±.00012"	4.311"	.315"	2.244"	.118"
3101-125E	4-5"/100-125mm	±.00012"	5.315"	.394"	2.756"	.118"
3101-150E	5-6"/125-150mm	±.00012"	6.319"	.394"	3.228"	.118"
3101-175E	6-7"/150-175mm	±.00016"	7.323"	.472"	3.720"	.217"
3101-200E	7-8"/175-200mm	±.00016"	8.327"	.472"	4.213"	.217"
3101-225E	8-9"/200-225mm	±.00016"	9.291"	.906"	5.098"	.217"
3101-250E	9-10"/225-250mm	±.00016"	10.295"	.906"	5.610"	.217"
3101-275E	10-11"/250-275mm	±.00020"	11.299"	.906"	6.102"	.217"
3101-300E	11-12"/275-300mm	±.00020"	12.303"	.906"	6.594"	.217"

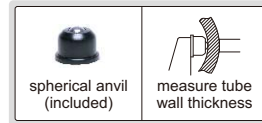
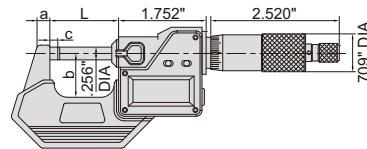

### Individual (friction thimble type)

Part No.	Range	Accuracy	L	a	b	c
3101-25FE*	0-1"/0-25mm	±.00008"	1.358"	.236"	.984"	.118"

\* Supplied with manufacturer inspection certificate traceable to NIST

### Set (ratchet stop type)

Part No.	Range	Micrometers included	Packaging
3101-44E*	0-4"/0-100mm	3101-25E, 3101-50E, 3101-75E, 3101-100E	blow mould case
3101-66E	0-6"/0-150mm	3101-25E, 3101-50E, 3101-75E, 3101-100E, 3101-125E, 3101-150E	aluminum box



ATTENTION: NO DATA OUTPUT

IP65 WATERPROOF

## ELECTRONIC OUTSIDE MICROMETERS (WITHOUT DATA OUTPUT)

- Resolution .00005"/0.001mm
- IP65 dust/waterproof
- Button function: on/off, set, inch/mm, ABS/INC
- Without data output
- LR44 battery, automatic power off
- Carbide measuring faces
- Supplied with spherical anvil
- Setting standards are included (except 0-1"/0-25mm)



3108-1



### Ratchet stop type

Part No.	Range	Accuracy	L	a	b	c
3108-1*	0-1"/0-25mm	±.00008"	1.358"	.236"	.984"	.118"
3108-2*	1-2"/25-50mm	±.00008"	2.343"	.315"	1.260"	.118"
3108-3*	2-3"/50-75mm	±.00012"	3.327"	.315"	1.752"	.118"
3108-4*	3-4"/75-100mm	±.00012"	4.311"	.315"	2.244"	.118"
3108-5	4-5"/100-125mm	±.00012"	5.315"	.394"	2.756"	.118"
3108-6	5-6"/125-150mm	±.00012"	6.319"	.394"	3.228"	.118"
3108-7	6-7"/150-175mm	±.00016"	7.323"	.472"	3.720"	.217"
3108-8	7-8"/175-200mm	±.00016"	8.327"	.472"	4.213"	.217"

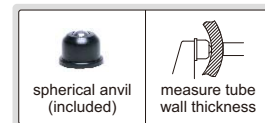
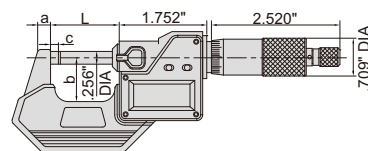

### Friction thimble type

Part No.	Range	Accuracy	L	a	b	c
3108-1F*	0-1"/0-25mm	±.00008"	1.358"	.236"	.984"	.118"

\* Supplied with manufacturer inspection certificate traceable to NIST

←INSIZE→		Inspection Certificate		
Product name	Outside Micrometer	Unit: inch		
Code No.	3203-1A	Measuring Length	Permissible Error	Error
Measuring range	0-1"	0.000	0.00015	0.0000
Graduation	0.0001"	0.210		0.0001
Serial No.	0910120004	0.420		-0.0001
Standard temperature	68 °F	0.605		0.0000
Based on	ASME B89.1.13-2013	0.815		-0.0001
Traceable to	USA NIST No.821/279484-10	1.000		0.0001
Inspector	<i>Paulo</i>	Judgement: Passed		

## MANUFACTURER INSPECTION CERTIFICATE TRACEABLE TO NIST, FOR MICROMETERS

5

### ELECTRONIC OUTSIDE MICROMETERS

- Resolution .00005"/0.001mm
- Button functions: on/off, set, inch/mm, ABS/INC
- No data output
- LR44 battery, automatic power off
- Carbide measuring faces
- Friction thimble
- Supplied with spherical anvil
- Setting standards are included (except 0-1"/0-25mm)

ATTENTION: NO  
DATA OUTPUT

**INSPECTION  
CERTIFICATE**  
TRACEABLE TO NIST



3109-25E

Part No.	Range	Accuracy	L	a	b
3109-25E *	0-1"/0-25mm	±.00010"	1.260"	.236"	1.083"
3109-50E *	1-2"/25-50mm	±.00015"	2.244"	.315"	1.457"
3109-75E *	2-3"/50-75mm	±.00015"	3.228"	.315"	1.969"
3109-100E *	3-4"/75-100mm	±.00015"	4.213"	.394"	2.402"

\* Supplied with manufacturer inspection certificate traceable to NIST

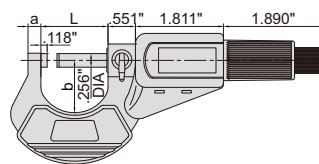

### OUTSIDE MICROMETERS WITH COUNTER

- Counter resolution .001"
- Thimble graduation .0001"
- Carbide measuring faces
- Ratchet stop
- Supplied with setting standards (except 0-1")

**INSPECTION  
CERTIFICATE**  
TRACEABLE TO NIST



3400-1

Part No.	Range	Accuracy	L	a	b
3400-1 *	0-1"	.00016"	1.260"	.236"	1.024"
3400-2 *	1-2"	.00016"	2.244"	.315"	1.260"
3400-3 *	2-3"	.00020"	3.228"	.315"	1.752"
3400-4 *	3-4"	.00020"	4.213"	.315"	2.244"

\* Supplied with manufacturer inspection certificate traceable to NIST

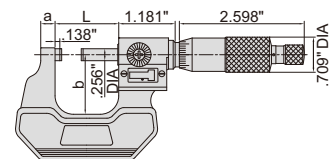

### OUTSIDE MICROMETERS FOR LEFT OR RIGHT HAND

- Graduation .001"
- Graduations on two sides
- Ratchet stop
- Carbide measuring faces
- Supplied with setting standards (except 0-1")

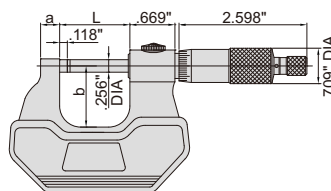

3236-1B

Part No.	Range	Accuracy	L	a	b
3236-1B	0-1"	.00016"	1.260"	.236"	.945"
3236-2B	1-2"	.00016"	2.244"	.315"	1.260"
3236-3B	2-3"	.00020"	3.228"	.315"	1.752"

## OUTSIDE MICROMETERS

- Graduation: imperial .0001"  
metric 0.01mm
- Carbide measuring faces
- Supplied with setting standards (except 0-1" and 0-25mm)

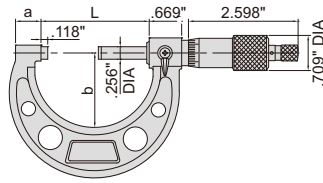

3203-1A



3203-2A



3203-44A



3203-126A

### Imperial (ratchet stop type)

Part No.	Range	Accuracy	L	a	b
3203-1A *	0-1"	.00016"	1.260"	.354"	1.102"
3203-2A *	1-2"	.00016"	2.244"	.551"	1.496"
3203-3A *	2-3"	.00020"	3.228"	.591"	1.929"
3203-4A *	3-4"	.00020"	4.213"	.591"	2.362"
3203-5A *	4-5"	.00024"	5.236"	.650"	2.874"
3203-6A *	5-6"	.00024"	6.220"	.650"	3.346"
3203-7A	6-7"	.00028"	7.205"	.764"	4.094"
3203-8A	7-8"	.00028"	8.228"	.764"	4.606"
3203-9A	8-9"	.00031"	9.213"	.764"	5.118"
3203-10A	9-10"	.00031"	10.236"	.764"	5.591"
3203-11A	10-11"	.00035"	11.220"	.764"	6.102"
3203-12A	11-12"	.00035"	12.205"	.764"	6.614"

### Metric (ratchet stop type)

Part No.	Range	Accuracy	L	a	b
3203-25A *	0-25mm	±2µm	32mm	9mm	28mm
3203-50A *	25-50mm	±2µm	57mm	14mm	38mm
3203-75A *	50-75mm	±2µm	82mm	15mm	49mm
3203-100A *	75-100mm	±3µm	107mm	15mm	60mm
3203-125A	100-125mm	±3µm	133mm	16.5mm	73mm
3203-150A	125-150mm	±3µm	158mm	16.5mm	85mm
3203-175A	150-175mm	±4µm	183mm	19.4mm	104mm
3203-200A	175-200mm	±4µm	209mm	19.4mm	117mm
3203-225A	200-225mm	±4µm	234mm	19.4mm	130mm
3203-250A	225-250mm	±5µm	260mm	19.4mm	142mm
3203-275A	250-275mm	±5µm	285mm	19.4mm	155mm
3203-300A	275-300mm	±5µm	310mm	19.4mm	168mm

\* Supplied with manufacturer inspection certificate traceable to NIST or DKD Germany

### Imperial micrometer set (ratchet stop type)

Part No.	Range	Micrometers included	Packaging
3203-33A *	0-3"	3203-1A, 3203-2A, 3203-3A	blow mould case
3203-44A *	0-4"	3203-1A, 3203-2A, 3203-3A, 3203-4A	blow mould case
3203-66A *	0-6"	3203-1A, 3203-2A, 3203-3A, 3203-4A, 3203-5A, 3203-6A	blow mould case
3203-126A	6-12"	3203-7A, 3203-8A, 3203-9A, 3203-10A, 3203-11A, 3203-12A	aluminum box
3203-1212A	0-12"	3203-1A, 3203-2A, 3203-3A, 3203-4A, 3203-5A, 3203-6A, 3203-7A, 3203-8A, 3203-9A, 3203-10A, 3203-11A, 3203-12A	aluminum box

### Imperial (friction thimble type)

Part No.	Range	Accuracy	L	a	b
3203-1FA *	0-1"	.00016"	1.260"	.354"	1.102"
3203-2FA *	1-2"	.00016"	2.244"	.551"	1.496"
3203-3FA *	2-3"	.00020"	2.244"	.591"	1.929"

### Metric micrometer set (ratchet stop type)

Part No.	Range	Micrometers included	Packaging
3203-753A *	0-75mm	3203-25A, 3203-50A, 3203-75A	blow mould case
3203-1004A *	0-100mm	3203-25A, 3203-50A, 3203-75A, 3203-100A	blow mould case
3203-1506A	0-150mm	3203-25A, 3203-50A, 3203-75A, 3203-100A, 3203-125A, 3203-150A	blow mould case
3203-3006A	150-300mm	3203-175A, 3203-200A, 3203-225A, 3203-250A, 3203-275A, 3203-300A	aluminum box
3203-3012A	0-300mm	3203-25A, 3203-50A, 3203-75A, 3203-100A, 3203-125A, 3203-150A, 3203-175A, 3203-200A, 3203-225A, 3203-250A, 3203-275A, 3203-300A	aluminum box



## OUTSIDE MICROMETERS WITH INTERCHANGEABLE ANVILS

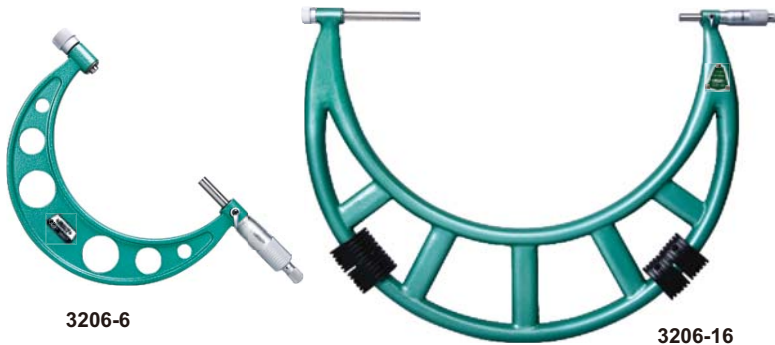

- Graduation .0001" (within 12")  
.001" (over 12")
- Ratchet stop
- Carbide measuring faces
- Supplied with setting standards

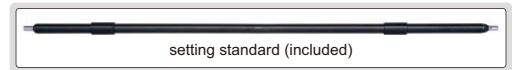

Part No.	Range	Type	Accuracy	L	b	Setting standard (included)
3206-2	0-2"	A	.00016"	2.283"	1.378"	1"
3206-4	0-4"	A	.00020"	4.252"	2.244"	1", 2", 3"
3206-6	0-6"	A	.00024"	6.220"	3.228"	1", 2", 3", 4", 5"
3206-61	2-6"	A	.00024"	6.220"	3.228"	2", 3", 4", 5"
3206-8	4-8"	A	.00028"	8.189"	4.488"	4", 5", 6", 7"
3206-12	6-12"	A	.00035"	12.126"	6.496"	6", 7", 8", 9", 10", 11"
3206-121	8-12"	A	.00035"	12.126"	6.496"	8", 9", 10", 11"
3206-16	12-16"	B	.00043"	16.102"	8.819"	13", 15"
3206-20	16-20"	B	.00051"	20.039"	10.827"	17", 19"
3206-24	20-24"	B	.00055"	23.976"	12.638"	21", 23"
3206-28	24-28"	B	.00063"	27.913"	14.606"	25", 27"
3206-32	28-32"	B	.00071"	31.850"	16.772"	29", 31"
3206-36	32-36"	B	.00079"	35.787"	18.740"	33", 35"
3206-40	36-40"	B	.00087"	39.724"	22.677"	37", 39"

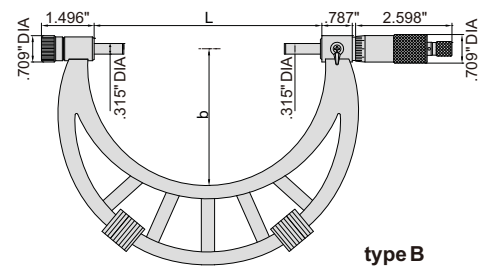
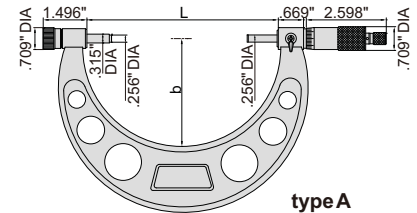

## ELECTRONIC OUTSIDE MICROMETERS WITH INTERCHANGEABLE ANVILS

**IP65**  
WATERPROOF

**DATA**  
OUTPUT

- Resolution .0001"/0.001mm (resolution of 3506-100E and 3506-150E is .00005"/0.001mm)
- IP65 dust/waterproof
- Button function: on/off, set, inch/mm, ABS/INC
- Data output
- LR44 battery, automatic power off
- Ratchet stop
- Carbide measuring faces
- Supplied with setting standards
- Optional accessory: data output cable (part no. 7306-30A, 7302-SPC6, 7305-SPC3A, 7305-B01)



3506-100E



3506-400E

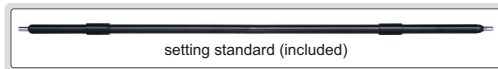

Part No.	Range	Type	Accuracy	L	b	Setting standard (included)
3506-100E	0-4"/0-100mm	A	±.00020"	4.134"	2.244"	1", 2", 3"
3506-150E	0-6"/0-150mm	A	±.00024"	6.102"	3.228"	1", 2", 3", 4", 5"
3506-300E	6-12"/150-300mm	A	±.00031"	12.008"	6.496"	1", 2", 3", 4", 5"
3506-301E	8-12"/200-300mm	A	±.00031"	12.008"	6.496"	8", 9", 10", 11"
3506-400E	12-16"/300-400mm	B	±.00035"	15.945"	8.819"	13", 15"
3506-500E	16-20"/400-500mm	B	±.00043"	19.882"	10.827"	17", 19"
3506-600E	20-24"/500-600mm	B	±.00047"	23.819"	12.638"	21", 23"
3506-700E	24-28"/600-700mm	B	±.00051"	27.756"	14.606"	25", 27"
3506-800E	28-32"/700-800mm	B	±.00059"	31.693"	16.772"	29", 31"
3506-900E	32-36"/800-900mm	B	±.00063"	35.630"	18.740"	33", 35"
3506-1000E	36-40"/900-1000mm	B	±.00067"	39.567"	22.677"	37", 39"

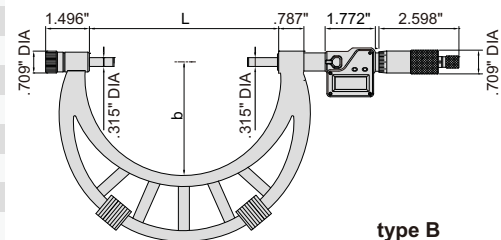
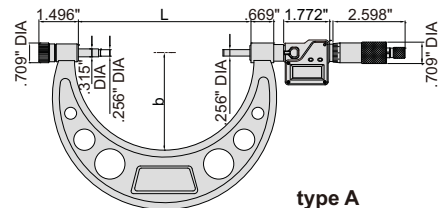

## OUTSIDE MICROMETERS WITH EXTENSION ANVIL COLLAR

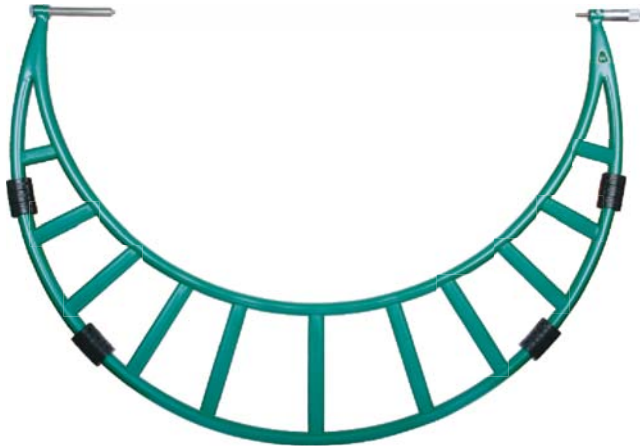

3205-56



adjust collars for different measuring ranges

- Graduation .0005"
- Adjust collars for different measuring ranges
- Ratchet stop
- Carbide measuring faces
- Supplied with setting standards

Part No.	Range	Accuracy	L	b	Setting standard (included)
3205-48	40-48"	.00087"	47.638"	25.394"	42", 46"
3205-56	48-56"	.00094"	55.512"	29.331"	50", 54"
3205-64	56-64"	.00110"	63.386"	33.268"	58", 62"
3205-72	64-72"	.00122"	71.260"	37.205"	66", 70"
3205-80	72-80"	.00134"	79.134"	41.142"	74", 78"

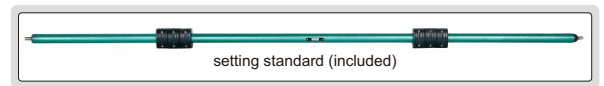
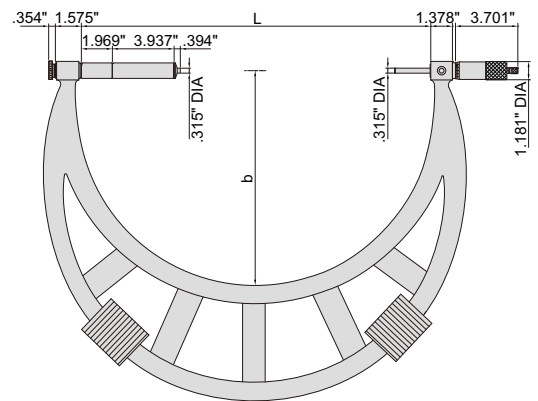

setting standard (included)

## INDICATING MICROMETERS

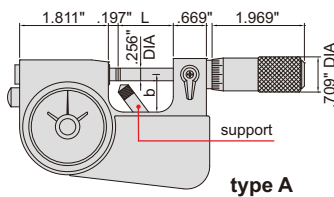

type A

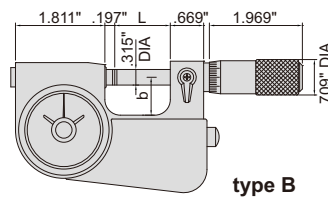

type B



3332-1



3332-1B

- Micrometer head graduation .0001"
- Dial indicator: range  $\pm 0.0015"$ , graduation .00005", accuracy .00005"
- Carbide measuring faces
- Supplied with setting standards (except 0-1")

Part No.	Micrometer head range	Micrometer head accuracy	Type	L	b	Remark
3332-1	0-1"	.00016"	A	1.122"	.748"	with support
3332-2	1-2"	.00016"	A	2.106"	1.181"	with support
3332-1B	0-1"	.00016"	B	1.122"	.748"	without support

## LIMIT MICROMETERS

- Used as Go/No-Go gauge by setting upper and lower limits
- Graduation .0001"
- Carbide measuring faces
- Supplied with setting standard (except 0-1")

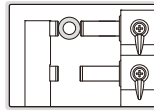

3235-1

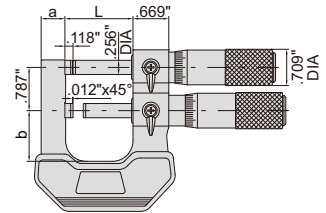

Part No.	Range	Accuracy	L	a	b
3235-1	0-1"	.00016"	1.260"	.472"	.945"
3235-2	1-2"	.00016"	2.244"	.591"	1.260"

5

## GROOVE MICROMETERS

ATTENTION: NO RACHET STOP

- Graduation .001"
- Measure width of grooves inside bores
- Non-rotating spindle
- Two graduations for inside and outside measurement



3287-1

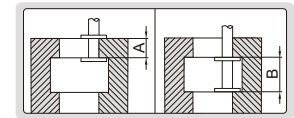

Part No.	Range (outside A)	Range (inside B)	Accuracy
3287-1	0-1"	.06-1.05"	.00039"
3287-2	1-2"	1.05-2.05"	.00039"
3287-3	2-3"	2.05-3.05"	.00039"
3287-4	3-4"	3.05-4.05"	.00039"

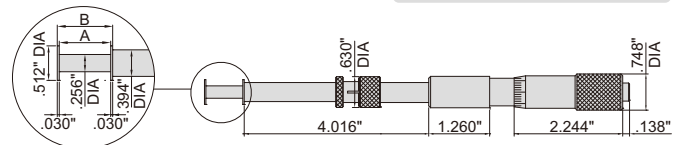

## MEASURING TIPS FOR SCREW THREAD MICROMETERS

- Supplied in pair
- Suitable for 3281, 3581 series micrometers



7381-T13

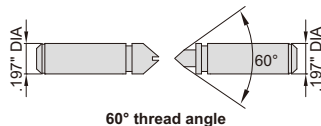

60° thread angle

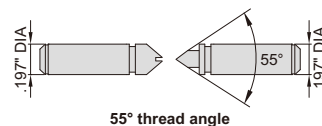

55° thread angle

### Unified and metric thread (60° thread angle)

Part No.	Pitch
7381-T11	64-48TPI/0.4-0.5mm
7381-T12	44-28TPI/0.6-0.9mm
7381-T13	24-14TPI/1-1.75mm
7381-T14	13-9TPI/2-3mm
7381-T15	8-5TPI/3.5-5mm
7381-T16	4.5-3.5TPI/5.5-7mm
7381-TS	6 pairs/set, including all above tips

### Whitworth thread (55° thread angle)

Part No.	Pitch
7381-T21	60-48TPI
7381-T22	48-40TPI
7381-T23	40-32TPI
7381-T24	32-24TPI
7381-T25	24-18TPI
7381-T26	18-14TPI
7381-T27	14-10TPI
7381-T28	10-7TPI
7381-T29	7-4.5TPI
7381-T210	4.5-3.5TPI
7381-T2S	10 pairs/set, including all above tips

**NON-ROTATING SPINDLE**

**SCREW THREAD MICROMETERS**

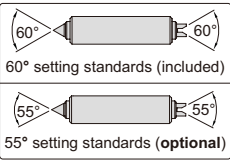

measuring tips are not included



3281-1

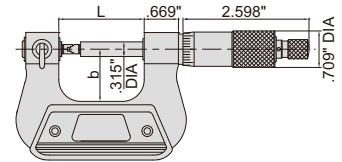
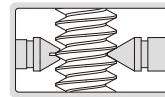

- Measure pitch diameter of screw threads
- Graduation .001"
- Non-rotating spindle
- Ratchet stop
- Supplied with 60° setting standards
- Optional accessory: 55° setting standards, measuring tips (part no. 7381)

Part No.	Range	L	b	55° setting standard (optional)
3281-1	0-1"	1.654"	1.024"	-
3281-2	1-2"	2.638"	1.496"	3281-SPE1
3281-3	2-3"	3.622"	1.969"	3281-SPE2
3281-4	3-4"	4.630"	2.441"	3281-SPE3
3281-5	4-5"	5.630"	2.756"	3281-SPE4
3281-6	5-6"	6.622"	3.228"	3281-SPE5
3281-7	6-7"	7.559"	3.720"	3281-SPE6
3281-8	7-8"	8.543"	4.213"	3281-SPE7

accuracy of micrometers with tips

Pitch	Range					
	0-1"	1-2"	2-3"	3-4"	4-5"	5-8"
64~48TPI	±394µin	-	-	-	-	-
44~32TPI	±394µin	±512µin	-	-	-	-
28~20TPI	±472µin	±591µin	±670µin	±670µin	-	-
18~13TPI	±551µin	±670µin	±748µin	±748µin	±787µin	±906µin
12~7TPI	±630µin	±748µin	±827µin	±827µin	±906µin	±984µin
6~3.5TPI	-	±827µin	±906µin	±906µin	±984µin	±1102µin

**DATA OUTPUT**

**NON-ROTATING SPINDLE**

**ELECTRONIC SCREW THREAD MICROMETERS**

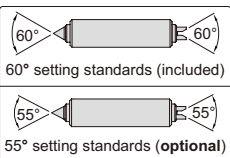

measuring tips are not included



3581-25E

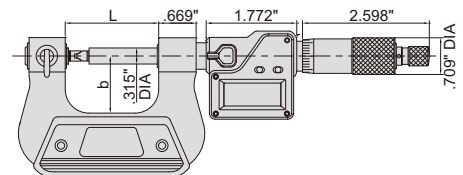
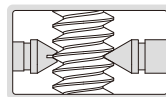

- Measure pitch diameter of screw threads
- Resolution .00005"/0.001mm
- Button function: on/off, set, inch/mm, ABS/INC
- Data output
- LR44 battery, automatic power off
- Non-rotating spindle
- Ratchet stop
- Supplied with 60° setting standards
- Optional accessory: 55° setting standards, measuring tips (part no. 7381), data output cable (part no. 7306-30A, 7302-SPC6, 7305-SPC3A, 7305-B01)

Part No.	Range	L	b	55° setting standard (optional)
3581-25E	0-1"/0-25mm	1.654"	1.024"	-
3581-50E	1-2"/25-50mm	2.638"	1.496"	3281-SPE1
3581-75E	2-3"/50-75mm	3.622"	1.969"	3281-SPE2
3581-100E	3-4"/75-100mm	4.630"	2.441"	3281-SPE3

accuracy of micrometers with tips

Pitch	Range			
	0-1"	1-2"	2-3"	3-4"
64~48TPI	±394µin	-	-	-
44~32TPI	±394µin	±512µin	-	-
28~20TPI	±472µin	±591µin	±670µin	±670µin
18~13TPI	±551µin	±670µin	±748µin	±748µin
12~7TPI	±630µin	±748µin	±827µin	±827µin
6~3.5TPI	-	±827µin	±906µin	±906µin



## POINT MICROMETERS

- Measure the web thickness of drills, small grooves and keyways
- Graduation .0001"
- Ratchet stop
- Carbide tips
- Supplied with setting standards (except 0-1")



3230-1

Part No.	Range	Type	Accuracy	L	b
3230-1	0-1"	A	.00016"	2.244"	1.260"
3230-2	1-2"	A	.00016"	3.228"	1.752"
3230-3	2-3"	A	.00020"	4.213"	2.244"
3230-4	3-4"	A	.00020"	5.220"	2.736"
3230-1B	0-1"	B	.00016"	2.244"	1.260"

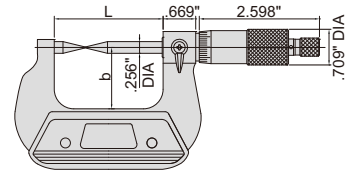
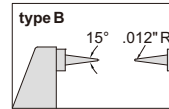
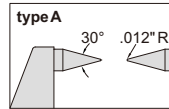

5

## ELECTRONIC POINT MICROMETERS

IP65  
WATERPROOF

DATA  
OUTPUT

- Measure the web thickness of drills, small grooves and keyways
- Resolution .00005"/0.001mm
- IP65 dust/waterproof
- Button function: on/off, set, inch/mm, ABS/INC
- Data output
- LR44 battery, automatic power off
- Ratchet stop
- Carbide tips
- Supplied with setting standards (except 0-1"/0-25mm)
- Optional accessory: data output cable (part no. 7306-30A, 7302-SPC6, 7305-SPC3A, 7305-B01)



3530-25E

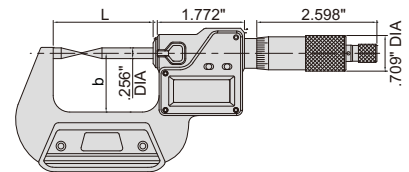
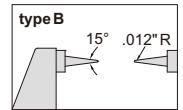
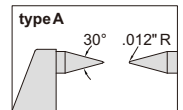

Part No.	Range	Type	Accuracy	L	b
3530-25E	0-1"/0-25mm	A	±.00016"	2.244"	1.260"
3530-25BE	0-1"/0-25mm	B	±.00016"	2.244"	1.260"
3530-50BE	1-2"/25-50mm	B	±.00016"	3.228"	1.752"

## BLADE MICROMETERS

NON-ROTATING  
SPINDLE

- Measure the groove diameter of shafts and keyways
- Graduation .0001"
- Non-rotating spindle
- Ratchet stop
- Supplied with setting standards (except 0-1")



3232-1

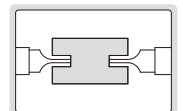

Part No.	Range	Type	Accuracy	L	b
3232-1	0-1"	A	.00016"	2.244"	1.260"
3232-2	1-2"	A	.00016"	3.228"	1.752"
3232-3	2-3"	A	.00020"	4.213"	2.244"
3232-4	3-4"	A	.00020"	5.220"	2.736"
3232-5	4-5"	A	.00024"	6.220"	3.228"
3232-6	5-6"	A	.00024"	7.220"	3.720"
3232-7	6-7"	A	.00028"	8.220"	4.213"
3232-1B	0-1"	B	.00016"	2.244"	1.260"
3232-2B	1-2"	B	.00016"	3.228"	1.752"

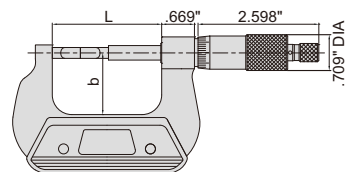
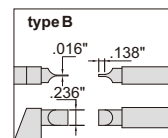
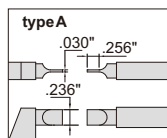

DATA  
OUTPUT

NON-ROTATING  
SPINDLE

## ELECTRONIC BLADE MICROMETERS

- Measure the groove diameter of shafts and keyways
- Resolution .00005"/0.001mm
- Non-rotating spindle
- Button function: on/off, set, inch/mm, ABS/INC
- Data output
- LR44 battery, automatic power off
- Ratchet stop
- Supplied with setting standards (except 0-1"/0-25mm)
- Optional accessory: data output cable (part no. 7306-30A, 7302-SPC6, 7305-SPC3A, 7305-B01)



3532-25E

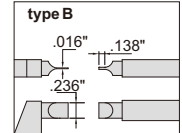
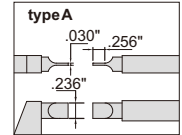

Part No.	Range	Type	Accuracy	L	b
3532-25E	0-1"/0-25mm	A	±.00016"	2.244"	1.260"
3532-50E	1-2"/25-50mm	A	±.00016"	3.228"	1.752"
3532-75E	2-3"/50-75mm	A	±.00020"	4.213"	2.244"
3532-100E	3-4"/75-100mm	A	±.00020"	5.220"	2.736"
3532-25BE	0-1"/0-25mm	B	±.00016"	2.244"	1.260"

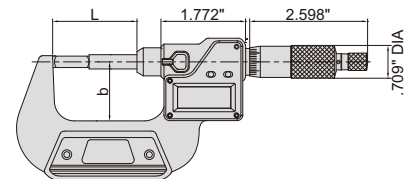
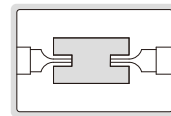

RELATIVE PRODUCT: ELECTRONIC CRIMP  
HEIGHT CALIPER (PART NO. 1165-150A)

## CRIMP HEIGHT MICROMETER



3266-1B

- Measure the height of crimp contact
- Graduation .0001"
- Ratchet stop

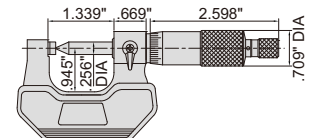
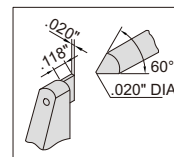
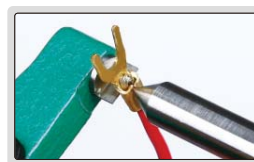

Part No.	Range	Accuracy
3266-1B	0-1"	.00016"

IP65  
WATERPROOF

DATA  
OUTPUT

RELATIVE PRODUCT: ELECTRONIC CRIMP  
HEIGHT CALIPER (PART NO. 1165-150A)

## ELECTRONIC CRIMP HEIGHT MICROMETER

- Measure the height of crimp contact
- Resolution .00005"/0.001mm
- IP65 dust/waterproof
- Button function: on/off, set, inch/mm, ABS/INC
- Data output
- LR44 battery, automatic power off
- Ratchet stop
- Optional accessory: data output cable (part no. 7306-30A, 7302-SPC6, 7305-SPC3A, 7305-B01)



3566-25BE

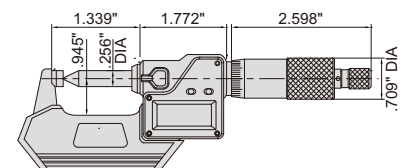
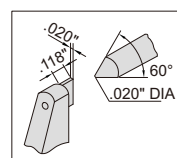
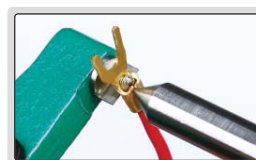

Part No.	Range	Accuracy
3566-25BE	0-1"/0-25mm	±.00016"

## SPLINE MICROMETERS

- Measure splined shafts, slots and keyways
- Graduation .0001"
- Ratchet stop
- Carbide measuring faces
- Supplied with setting standards (except 0-1")

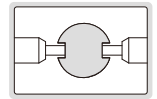

Part No.	Range	Type	Accuracy	L	b
3233-1	0-1"	A	.00016"	2.244"	1.260"
3233-1B	0-1"	B	.00016"	2.244"	1.260"
3233-2B	1-2"	B	.00016"	3.228"	1.752"
3233-3B	2-3"	B	.00020"	4.213"	2.244"
3233-4B	3-4"	B	.00020"	5.220"	2.736"
3233-5B	4-5"	B	.00024"	6.220"	3.228"
3233-6B	5-6"	B	.00024"	7.220"	3.720"
3233-7B	6-7"	B	.00028"	8.220"	4.213"

3233-1

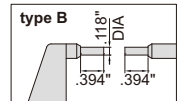
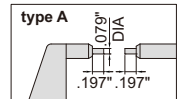
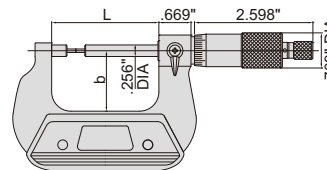

5

## ELECTRONIC SPLINE MICROMETERS

**IP65**  
WATERPROOF

DATA  
OUTPUT

- Measure splined shafts, slots and keyways
- Resolution .00005"/0.001mm
- IP65 dust/waterproof
- Button function: on/off, set, inch/mm, ABS/INC
- Data output
- LR44 battery, automatic power off
- Ratchet stop
- Carbide measuring faces
- Supplied with setting standards (except 0-1"/0-25mm)
- Optional accessory: data output cable (part no. 7306-30A, 7302-SPC6, 7305-SPC3A, 7305-B01)

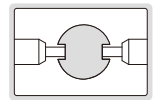

3533-25E

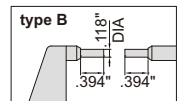
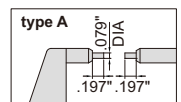
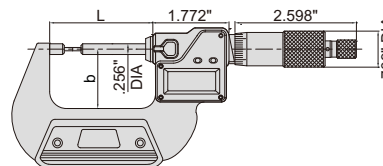

Part No.	Range	Type	Accuracy	L	b
3533-25E	0-1"/0-25mm	A	±.00016"	2.244"	1.260"
3533-25BE	0-1"/0-25mm	B	±.00016"	2.244"	1.260"
3533-50BE	1-2"/25-50mm	B	±.00016"	3.228"	1.752"

## CYLINDRICAL ANVIL TUBE MICROMETERS

- Measure wall thickness of tubes
- Graduation .0001"
- Ratchet stop
- Carbide spindle tip
- Supplied with setting standards (except 0-1")

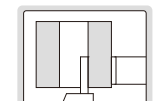

3261-1

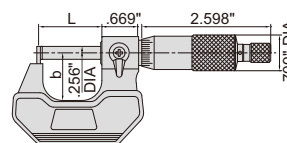

Part No.	Range	Type	Accuracy	L	b
3261-1	0-1"	A	.00024"	1.220"	.945"
3261-2	1-2"	A	.00024"	2.244"	1.260"
3261-1B	0-1"	B	.00024"	1.220"	.945"
3261-2B	1-2"	B	.00024"	2.244"	1.260"
3261-1C	0-1"	C	.00024"	1.220"	.945"
3261-1D	0-1"	D	.00024"	1.220"	.945"

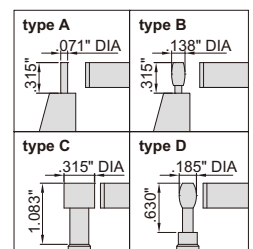

**IP65**  
WATERPROOF

**DATA**  
OUTPUT

## ELECTRONIC CYLINDRICAL ANVIL TUBE MICROMETERS

- Measure wall thickness of tubes
- Resolution .00005"/0.001mm
- IP65 dust/waterproof
- Button function: on/off, set, inch/mm, ABS/INC
- Data output
- LR44 battery, automatic power off
- Ratchet stop
- Carbide spindle tip
- Optional accessory: data output cable (part no. **7306-30A**, **7302-SPC6**, **7305-SPC3A**, **7305-B01**)



3561-25E

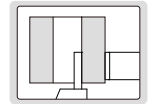

Part No.	Range	Type	Accuracy
3561-25E	0-1"/0-25mm	A	±.00024"
3561-25DE	0-1"/0-25mm	D	±.00024"

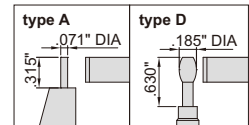
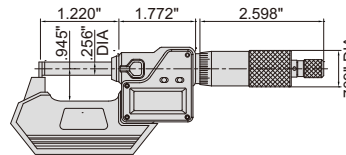

5

## SPHERICAL ANVIL TUBE MICROMETERS

- Measure wall thickness of tubes
- Graduation .0001"
- Ratchet stop
- Carbide measuring faces
- Supplied with setting standards (except 0-1")

Part No.	Range	Type	Accuracy	L	b
3260-1	0-1"	A	.00016"	1.260"	.945"
3260-2	1-2"	A	.00016"	2.244"	1.260"
3260-3	2-3"	A	.00020"	3.228"	1.752"
3260-4	3-4"	A	.00020"	4.213"	2.244"
3260-1S	0-1"	B	.00016"	1.260"	.945"
3260-2S	1-2"	B	.00016"	2.244"	1.260"
3260-3S	2-3"	B	.00020"	3.228"	1.752"
3260-4S	3-4"	B	.00020"	4.213"	2.244"



3260-1

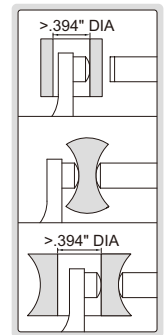
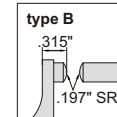
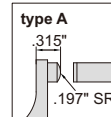
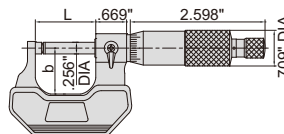

**IP65**  
WATERPROOF

**DATA**  
OUTPUT

## ELECTRONIC SPHERICAL ANVIL TUBE MICROMETERS

- Measure wall thickness of tubes
- Resolution .00005"/0.001mm
- IP65 dust/waterproof
- Button function: on/off, set, inch/mm, ABS/INC
- Data output
- LR44 battery, automatic power off
- Ratchet stop
- Carbide measuring faces
- Supplied with setting standards (except 0-1"/0-25mm)
- Optional accessory: data output cable (part no. **7306-30A**, **7302-SPC6**, **7305-SPC3A**, **7305-B01**)



3560-25E

Part No.	Range	Type	Accuracy	L	b
3560-25E	0-1"/0-25mm	A	±.00016"	1.260"	.945"
3560-50E	1-2"/25-50mm	A	±.00016"	2.244"	1.260"
3560-25SE	0-1"/0-25mm	B	±.00016"	1.260"	.945"
3560-50SE	1-2"/25-50mm	B	±.00016"	2.244"	1.260"

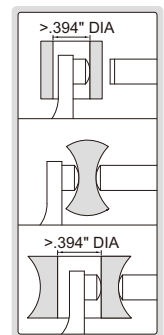
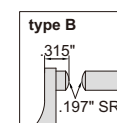
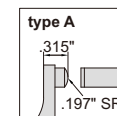
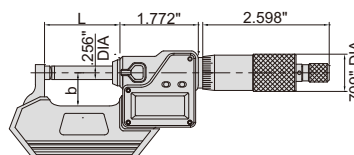



## DISK BRAKE MICROMETERS

RELATIVE PRODUCT: ELECTRONIC DISK BRAKE AND PAD CALIPER  
ELECTRONIC DRUM BRAKE CALIPER (PART NO. 1162-125A, 1167-150A, 1168-300A)

- Measure thickness of disk brakes
- Graduation .0001"
- Ratchet stop
- Carbide measuring faces
- Supplied with setting standards



3288-1

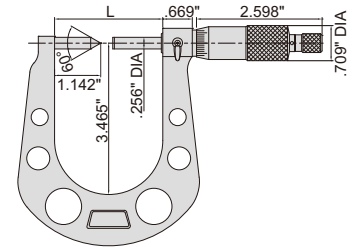

Part No.	Range	Accuracy	L
3288-1	.3-1.3"	.00020"	2.539"
3288-2	1-2"	.00020"	3.228"

## ELECTRONIC DISK BRAKE MICROMETERS

RELATIVE PRODUCT: ELECTRONIC DISK BRAKE AND PAD CALIPER  
ELECTRONIC DRUM BRAKE CALIPER (PART NO. 1162-125A, 1167-150A, 1168-300A)

- Measure thickness of disk brakes
- Resolution .00005"/0.001mm
- IP65 dust/waterproof
- Button function: on/off, set, inch/mm, ABS/INC
- Data output
- LR44 battery, automatic power off
- Ratchet stop
- Carbide measuring faces
- Supplied with setting standards
- Optional accessory: data output cable (part no. 7306-30A, 7302-SPC6, 7305-SPC3A, 7305-B01)

**IP65**  
WATERPROOF

DATA  
OUTPUT



3588-33E

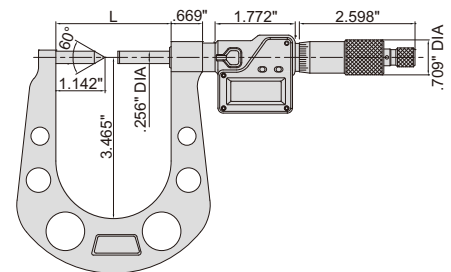

Part No.	Range	Accuracy	L
3588-33E	.3-1.3"/7.6-33mm	±.00020"	2.539"
3588-50E	1-2"/25-50mm	±.00020"	3.228"

## SHEET METAL MICROMETERS

- Deep frame suitable for sheet metal, paper and plastic
- Graduation .0001"
- Ratchet stop
- Carbide measuring faces

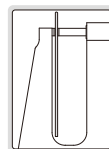

3239-13

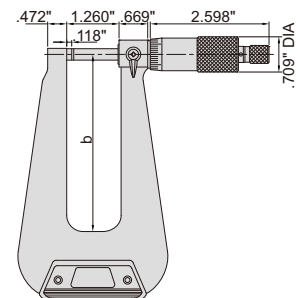

Part No.	Range	Type	Accuracy	b
3239-13	0-1"	A	.00028"	6.102"
3239-13F	0-1"	B	.00028"	6.102"
3239-14F	0-1"	B	.00040"	12.205"
3239-13S	0-1"	C	.00028"	6.102"

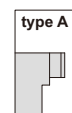

type A

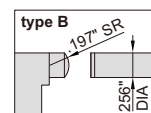

type B

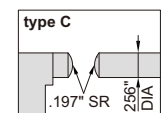

type C

**IP65**  
WATERPROOF

**DATA**  
OUTPUT

## ELECTRONIC SHEET METAL MICROMETER

- Deep frame suitable for sheet metal, paper and plastic
- Resolution .00005"/0.001mm
- IP65 dust/waterproof
- Button function: on/off, set, inch/mm, ABS/INC
- Data output
- LR44 battery, automatic power off
- Ratchet stop
- Carbide measuring faces
- Optional accessory: data output cable (part no. **7306-30A**, **7302-SPC6**, **7305-SPC3A**, **7305-B01**)



**3539-253SE**

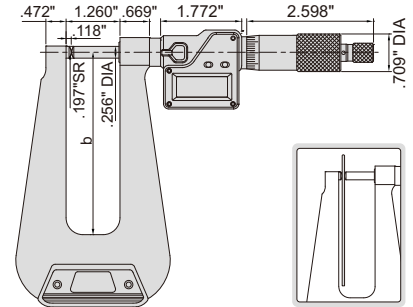

Part No.	Range	Accuracy	b
<b>3539-253SE</b>	0-1"/0-25mm	±.00028"	6.102"

5

## INTERCHANGEABLE ANVIL MICROMETERS

- Measure tube thickness, shoulder edge distance, rivet head height, etc.
- Supplied with flat anvil and rod anvil
- Graduation .0001"
- Ratchet stop
- Carbide spindle tip
- Setting standards are included (except 0-1")



**3262-2**

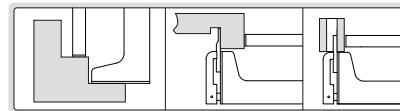

Part No.	Range	Accuracy	L	d
<b>3262-1</b>	0-1"	.00016"	1.122"	.118" DIA
<b>3262-2</b>	1-2"	.00016"	2.106"	.197" DIA

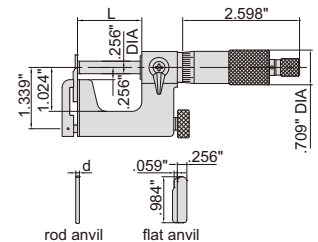

**IP65**  
WATERPROOF

**DATA**  
OUTPUT

## ELECTRONIC INTERCHANGEABLE ANVIL MICROMETERS

- Measure tube thickness, shoulder edge distance, rivet head height, etc.
- Supplied with flat anvil and rod anvil
- Resolution .00005"/0.001mm
- IP65 dust/waterproof
- Button function: on/off, set, inch/mm, ABS/INC
- Data output
- LR44 battery, automatic power off
- Ratchet stop
- Carbide spindle tip
- Setting standards are included (except 0-1"/0-25mm)
- Optional accessory: data output cable (part no. **7306-30A**, **7302-SPC6**, **7305-SPC3A**, **7305-B01**)



**3562-25E**

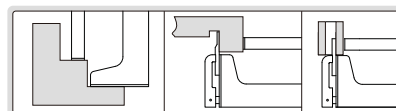

Part No.	Range	Accuracy	L	d
<b>3562-25E</b>	0-1"/0-25mm	±.00016"	1.122"	.118" DIA
<b>3562-50E</b>	1-2"/25-50mm	±.00016"	2.106"	.197" DIA

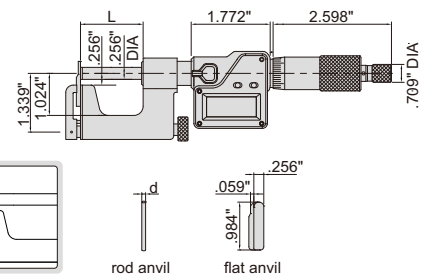

## V-ANVIL MICROMETERS



3290-063

- Measure the outside diameter of cutting tools (such as taps, reamers, end mills) with 3, 5 flutes or 7 flutes
- Graduation .0001"
- Ratchet stop
- Carbide measuring faces
- Supplied with setting standards

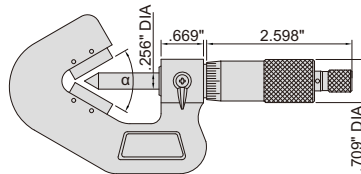

Part No.	Range	Flutes	$\alpha$	Accuracy
3290-063	.04-.6"	3	60°	.00016"
3290-083	.2-.8"	3	60°	.00016"
3290-143	.8-1.4"	3	60°	.00020"
3290-203	1.4-2"	3	60°	.00020"
3290-263	2-2.6"	3	60°	.00024"
3290-323	2.6-3.2"	3	60°	.00024"
3290-383	3.2-3.8"	3	60°	.00028"
3290-105	.2-1"	5	108°	.00016"
3290-185	1-1.8"	5	108°	.00020"
3290-265	1.8-2.6"	5	108°	.00024"
3290-345	2.6-3.4"	5	108°	.00028"
3290-107	.2-1"	7	128°34'17"	.00016"
3290-187	1-1.8"	7	128°34'17"	.00020"
3290-267	1.8-2.6"	7	128°34'17"	.00024"
3290-347	2.6-3.4"	7	128°34'17"	.00028"

5

## ELECTRONIC V-ANVIL MICROMETERS

IP65  
WATERPROOF

DATA  
OUTPUT



3590-153E

- Measure the outside diameter of cutting tools (such as taps, reamers, end mills) with 3 flutes or 7 flutes
- Resolution .00005"/0.001mm
- IP65 dust/waterproof
- Button function: on/off, set, inch/mm, ABS/INC
- Data output
- LR44 battery, automatic power off
- Ratchet stop
- Carbide measuring faces
- Supplied with setting standards
- Optional accessory: data output cable (part no. 7306-30A, 7302-SPC6, 7305-SPC3A, 7305-B01)

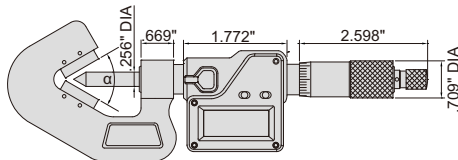

Part No.	Range	Flutes	$\alpha$	Accuracy
3590-153E	.04-.6"/1-15mm	3	60°	±.00016"
3590-203E	.2-.8"/5-20mm	3	60°	±.00016"
3590-353E	.8-1.4"/20-35mm	3	60°	±.00020"
3590-503E	1.4-2"/35-50mm	3	60°	±.00020"
3590-257E	.2-1"/5-25mm	7	128°34'17"	±.00016"
3590-457E	1-1.8"/25-45mm	7	128°34'17"	±.00016"
3590-657E	1.8-2.6"/45-65mm	7	128°34'17"	±.00020"
3590-857E	2.6-3.4"/65-85mm	7	128°34'17"	±.00020"

## NON-ROTATING SPINDLE UNIVERSAL MICROMETERS

NON-ROTATING  
SPINDLE

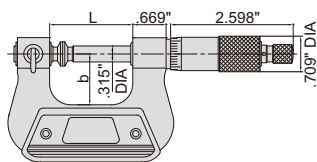

3280-1

- Graduation .0001"
- Non-rotating spindle
- Ratchet stop
- Supplied with 7 pairs of anvil/spindle tip
- Setting standards are included (except 0-1")
- Optional accessory: 55° anvil/spindle tip (part no. 3280-SP1 and 3280-SP2)

Part No.	Range	Accuracy	L	b
3280-1	0-1"	.00016"	1.654"	1.024"
3280-2	1-2"	.00016"	2.638"	1.496"

55° anvil/spindle tip (optional)

Part No. 3280-SP1 Knife-edge		
Part No. 3280-SP2 Point		

Anvil/spindle tip (included)

Flat		
Spherical		
Spline		
Disk		
Blade		
Knife-edge		
Point		

NON-ROTATING SPINDLE

DATA OUTPUT

## ELECTRONIC UNIVERSAL MICROMETERS

- Resolution .00005"/0.001mm
- Non-rotating spindle
- Button function: on/off, set, inch/mm, ABS/INC
- Data output
- LR44 battery, automatic power off
- Ratchet stop
- Supplied with 7 pairs of anvil/spindle tip (same as series 3280)
- Setting standards are included (except 0-1"/0-25mm)
- Optional accessory: 55° anvil/spindle tip part no. **3280-SP1** and **3280-SP2** (same as series 3280), data output cable (part no. **7306-30A**, **7302-SPC6**, **7305-SPC3A**, **7305-B01**)



3580-25E

supplied with 7 pairs of anvil/spindle tip (same as series 3280)

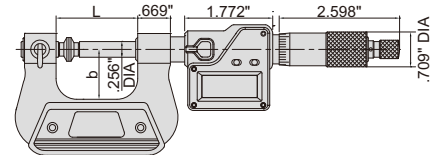

Part No.	Range	Accuracy	L	b
3580-25E	0-1"/0-25mm	±.00016"	1.654"	1.024"
3580-50E	1-2"/25-50mm	±.00016"	2.638"	1.496"

5

NON-ROTATING SPINDLE

## NON-ROTATING SPINDLE DISK MICROMETERS

- Measure root tangent length of gear
- Graduation .0001"
- Non-rotating spindle
- Ratchet stop
- Supplied with setting standards

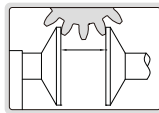

3294-1

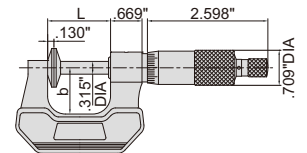
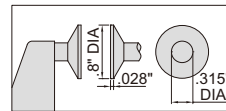

Part No.	Range	Accuracy	Parallelism	L	b
3294-1	0-1"	.00016"	.00020"	1.339"	.945"
3294-2	1-2"	.00016"	.00020"	2.323"	1.260"
3294-3	2-3"	.00020"	.00020"	3.346"	1.772"
3294-4	3-4"	.00020"	.00020"	4.331"	2.244"

NON-ROTATING SPINDLE

DATA OUTPUT

## ELECTRONIC NON-ROTATING SPINDLE DISK MICROMETERS

- Measure root tangent length of gear
- Resolution .00005"/0.001mm
- Non-rotating spindle
- Button function: on/off, set, inch/mm, ABS/INC
- Data output
- LR44 battery, automatic power off
- Ratchet stop
- Supplied with setting standards
- Optional accessory: data output cable (part no. **7306-30A**, **7302-SPC6**, **7305-SPC3A**, **7305-B01**)

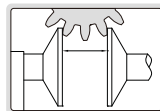

3594-1

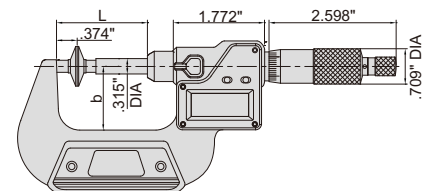
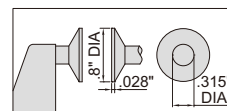

Part No.	Range	Accuracy	Parallelism	L	b
3594-1	0-1"/0-25mm	±.00016"	±.00020"	1.693"	1.260"
3594-2	1-2"/25-50mm	±.00016"	±.00020"	2.677"	1.752"
3594-3	2-3"/50-75mm	±.00020"	±.00020"	3.661"	2.244"
3594-4	3-4"/75-100mm	±.00020"	±.00020"	4.665"	2.756"



## DISK MICROMETERS

- Measure root tangent length of gear
- Graduation .0001"
- Ratchet stop
- Supplied with setting standards

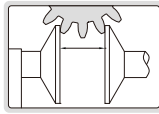

3282-1

Part No.	Range	Accuracy	Parallelism	L	b
3282-1	0-1"	.00016"	.00020"	1.339"	.945"
3282-2	1-2"	.00016"	.00020"	2.323"	1.260"
3282-3	2-3"	.00020"	.00020"	3.346"	1.772"
3282-4	3-4"	.00020"	.00020"	4.331"	2.244"

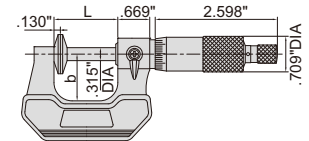
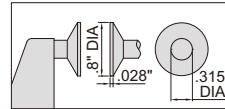

5

## CALIPER TYPE MICROMETERS

- Graduation .001"
- Non-rotating spindle
- Ratchet stop
- Carbide measuring faces
- Supplied with setting standards (except 0-1")



3238-1

Part No.	Range	Accuracy	L
3238-1	0-1"	.00020"	2.205"
3238-2	1-2"	.00024"	3.189"

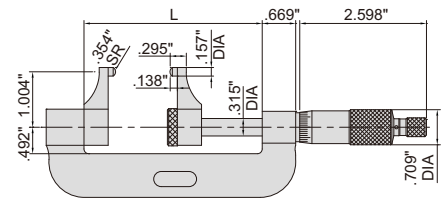
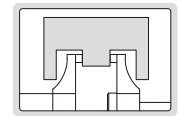

## SHEET METAL MICROMETER

- Measure thickness of sheet metal, paper, plastic and rubber parts
- Graduation .001"
- Ratchet stop
- Carbide measuring faces

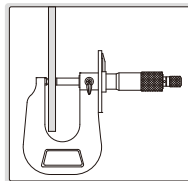

3263-1

Part No.	Range	Accuracy
3263-1	0-1"	.00016"

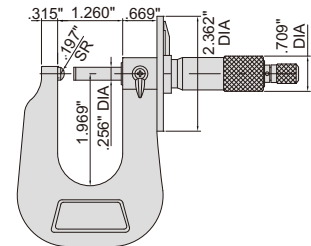

## HUB MICROMETERS

- Measure hub thickness and shoulder inside a bore
- Graduation .0001"
- Ratchet stop
- Carbide measuring faces
- Supplied with setting standards (except 0-1")



3292-1

Part No.	Range	Accuracy	h1	h2	H
3292-1	0-1"	.00016"	.236"	.354"	.736"
3292-2	1-2"	.00016"	.256"	.433"	.835"
3292-3	2-3"	.00020"	.256"	.433"	.835"
3292-4	3-4"	.00020"	.256"	.433"	.835"

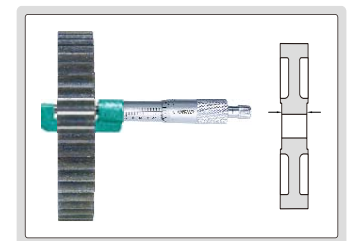
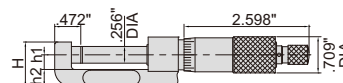

## WIRE MICROMETER

- Measure diameter of wires and small balls
- Graduation .0001"
- Ratchet stop
- Carbide measuring faces



3285-4

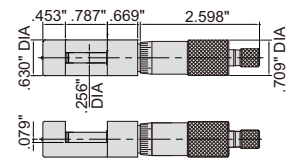
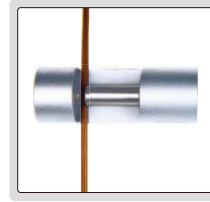

Part No.	Range	Accuracy
3285-4	0-.4"	.00016"

## CAN SEAM MICROMETERS

5



3293-061



3293-062



3293-063

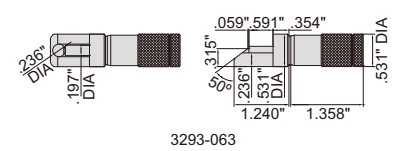
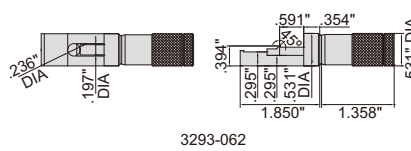
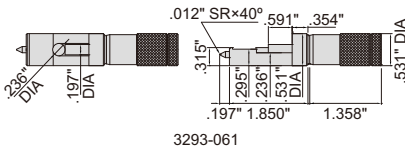

- Measure the width, height and depth of can seams
- Graduation .001"

Part No.	Range	Accuracy
3293-061	0-.5"	.00016"
3293-062	0-.5"	.00016"
3293-063	0-.5"	.00016"

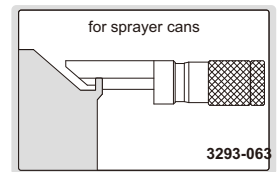
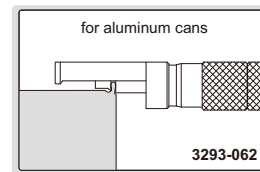
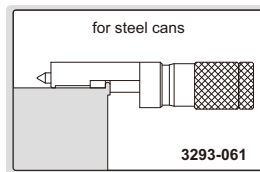

## MICROMETER MEASURING FORCE DETECTOR

- For outside micrometers  
0-1"/0-25mm, 1-2"/25-50mm,  
2-3"/50-75mm and 3-4"/75-100mm

Part No.	Measuring force
6315	5-12N



6315

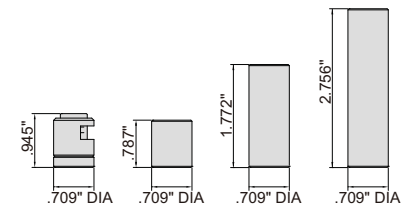

## MICROMETER STAND

- Suitable for micrometers up to 4"

Part No.
6300



6300

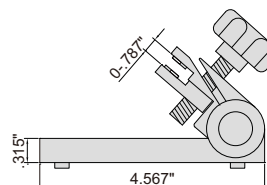

## MICROMETER STAND

- Suitable for micrometers up to 4"

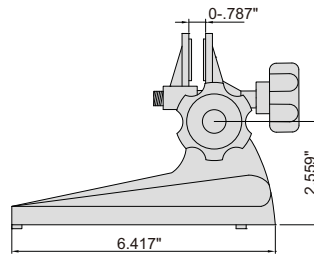

6301

Part No.  
6301

- Suitable for inside micrometers

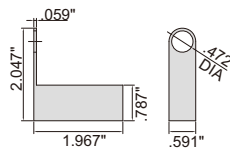

6301-1

Part No.	Description	Applicable products
6301-1	clamp for inside micrometers	all sizes of 3220 series

- Suitable for three points internal micrometers

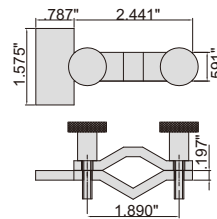

6301-2

Part No.	Description	Applicable products
6301-2	clamp for three points internal micrometers	up to 4" of 3127 and 3227 series

## MICROMETER SETTING STANDARDS

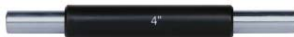

6311-4



6311-12

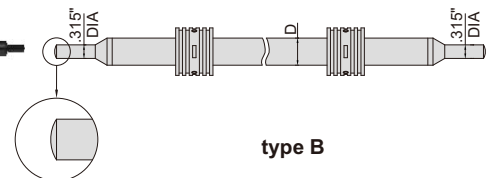

type B



type A

Part No.	Length	Type	Accuracy	D (DIA)
6311-1	1"	A	±.00006"	.276"
6311-2	2"	A	±.00008"	.276"
6311-3	3"	A	±.00010"	.276"
6311-4	4"	A	±.00012"	.315"
6311-5	5"	A	±.00014"	.315"
6311-6	6"	A	±.00016"	.315"
6311-7	7"	A	±.00018"	.315"
6311-8	8"	A	±.00020"	.315"
6311-9	9"	A	±.00022"	.315"
6311-10	10"	A	±.00024"	.315"
6311-11	11"	A	±.00026"	.315"
6311-12	12"	B	±.00028"	.630"
6311-13	13"	B	±.00030"	.630"
6311-14	14"	B	±.00031"	.630"
6311-15	15"	B	±.00033"	.630"

Part No.	Length	Type	Accuracy	D (DIA)
6311-16	16"	B	±.00035"	.630"
6311-17	17"	B	±.00037"	.630"
6311-18	18"	B	±.00039"	.630"
6311-19	19"	B	±.00041"	.630"
6311-20	20"	B	±.00043"	.630"
6311-21	21"	B	±.00045"	.630"
6311-23	23"	B	±.00049"	.630"
6311-25	25"	B	±.00053"	.630"
6311-27	27"	B	±.00057"	.630"
6311-29	29"	B	±.00061"	.630"
6311-31	31"	B	±.00065"	.630"
6311-33	33"	B	±.00069"	.630"
6311-35	35"	B	±.00073"	.630"
6311-37	37"	B	±.00077"	.630"
6311-39	39"	B	±.00081"	.630"



**IP65**  
WATERPROOF

**DATA**  
OUTPUT

## ELECTRONIC MICROMETER HEADS

- Resolution .00005"/0.001mm
- IP65 dust/waterproof
- Button function: on/off, set, inch/mm, ABS/INC
- Data output
- LR44 battery, automatic power off
- Ratchet stop
- Optional accessory: data output cable (part no. 7306-30A, 7302-SPC6, 7305-SPC3A, 7305-B01)



6353-25W

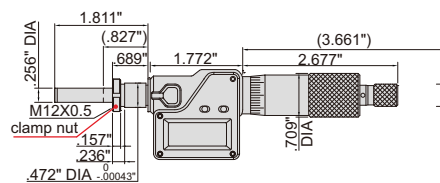

6353-25

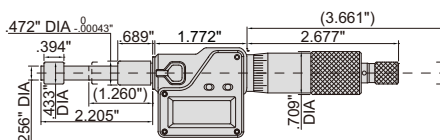

6353-25W

### Rotating spindle

Part No.	Range	Stem	Spindle tip	Accuracy
6353-25	0-1"/0-25mm	with clamp nut	flat (carbide)	±.00008"
6353-25W	0-1"/0-25mm	plain	flat (carbide)	±.00008"

### Non-rotating spindle

Part No.	Range	Stem	Spindle tip	Accuracy
6354-25W	0-1"/0-25mm	plain	flat	±.00008"

5

## MICROMETER HEADS



6381-1W

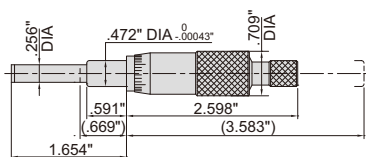

6381-1W



6381-25W

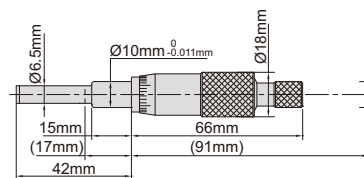

6381-25W

- Ratchet stop

Part No.	Range	Graduation	Spindle tip	Accuracy
6381-1W	0-1"	.001"	flat (carbide)	.00012"
6381-25W	0-25mm	0.01mm	flat (carbide)	3µm

## NON-ROTATING SPINDLE MICROMETER HEAD



6377-1

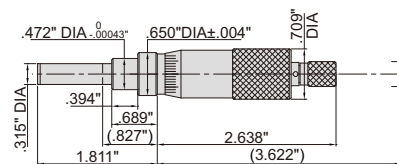

- Graduation .001"
- Ratchet stop
- Non-rotating spindle

Part No.	Range	Spindle tip	Accuracy
6377-1	0-1"	flat (carbide)	.00012"



# PISTOL GRIP THREE POINTS BORE GAGES

**INSIZE**  
INSPECTION  
CERTIFICATE

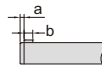
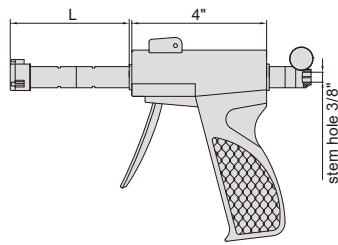

**Type A**  
.275-.5", steel  
measuring points



2124-E035

electronic indicator  
is not included

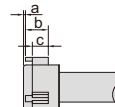

**Type B**  
.5-2", carbide  
measuring points



2124-E1

electronic indicator  
is not included

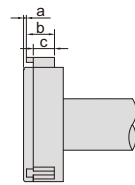

**Type C**  
2-12", carbide  
measuring points



2124-E5

electronic indicator  
is not included

**Manufacturer Inspection Certificate**

Actual Ring Size (inch)		Permissible Error (without digital indicator)	Measured Deviation	Unit: inch
1.02260			0	
1.10228	.00016	.00010		
1.18107		.00010		

**Individual**

Part No.	Range	Type	Accuracy (without electronic indicator)	Setting ring	Extension rod	L	a	b	c
2124-E035 *	.275-.35"	A	.00016"	.275" DIA (included)	4" (included)	2"	.059"	.098"	—
2124-E0425 *	.35-.425"	A	.00016"	.35" DIA (included)	4" (included)	2"	.059"	.098"	—
2124-E05 *	.425-.5"	A	.00016"	.5" DIA (included)	4" (included)	2"	.059"	.098"	—
2124-E065 *	.5-.65"	B	.00016"	.65" DIA (included)	6" (included)	2.6"	.020"	.236"	.177"
2124-E08 *	.65-.8"	B	.00016"	.65" DIA (included)	6" (included)	2.6"	.020"	.236"	.177"
2124-E1 *	.8-1"	B	.00016"	1" DIA (included)	6" (included)	3.64"	.020"	.315"	.236"
2124-E112 *	1-1.2"	B	.00016"	1" DIA (included)	6" (included)	3.64"	.020"	.315"	.236"
2124-E16 *	1.2-1.6"	B	.00016"	1.6" DIA (included)	6" (included)	3.88"	.020"	.551"	.472"
2124-E2 *	1.6-2"	B	.00020"	1.6" DIA (included)	6" (included)	3.88"	.020"	.551"	.472"
2124-E25 *	2-2.5"	C	.00020"	2.5" DIA (included)	6" (included)	4.48"	.020"	.689"	.571"
2124-E3 *	2.5-3"	C	.00020"	2.5" DIA (included)	6" (included)	4.48"	.020"	.689"	.571"
2124-E35 *	3-3.5"	C	.00020"	3.5" DIA (included)	6" (included)	4.48"	.020"	.689"	.571"
2124-E4 *	3.5-4"	C	.00020"	3.5" DIA (included)	6" (included)	4.48"	.020"	.689"	.571"
2124-E5 *	4-5"	C	.00024"	(optional)	6" (included)	5.51"	.035"	1.142"	.984"
2124-E6 *	5-6"	C	.00024"	(optional)	6" (included)	5.51"	.035"	1.142"	.984"
2124-E7 *	6-7"	C	.00028"	(optional)	6" (included)	5.51"	.035"	1.142"	.984"
2124-E8 *	7-8"	C	.00028"	(optional)	6" (included)	5.51"	.035"	1.142"	.984"
2124-E9	8-9"	C	.00032"	(optional)	6" (included)	5.51"	.035"	1.142"	.984"
2124-E10	9-10"	C	.00032"	(optional)	6" (included)	5.51"	.035"	1.142"	.984"
2124-E11	10-11"	C	.00036"	(optional)	6" (included)	5.51"	.035"	1.142"	.984"
2124-E12	11-12"	C	.00036"	(optional)	6" (included)	5.51"	.035"	1.142"	.984"

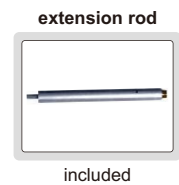

**Set**

Part No.	Range	Probes included	Setting ring (included)	Extension rod (included)
2124-E053 *	.275-.5"	.275-.35", .35-.425", .425-.5"	.275" DIA, .35" DIA, .5" DIA	4"
2124-E082 *	.5-.8"	.5-.65", .65-.8"	.65" DIA	6"
2124-E24 *	.8-2"	.8-1", 1-1.2", 1.2-1.6", 1.6-2"	1" DIA, 1.6" DIA	6"
2124-E44 *	2-4"	2-2.5", 2.5-3", 3-3.5", 3.5-4"	2.5" DIA, 3.5" DIA	6"



2124- E24

\* Supplied with manufacturer inspection certificate

### THREE POINTS INTERNAL MICROMETERS

- .275-.5": graduation .0001"
- .5-12": graduation .0002"
- Ratchet stop
- Optional accessory: setting rings (part no. 6313), micrometer stand and clamp (part no. 6301 and 6301-2)

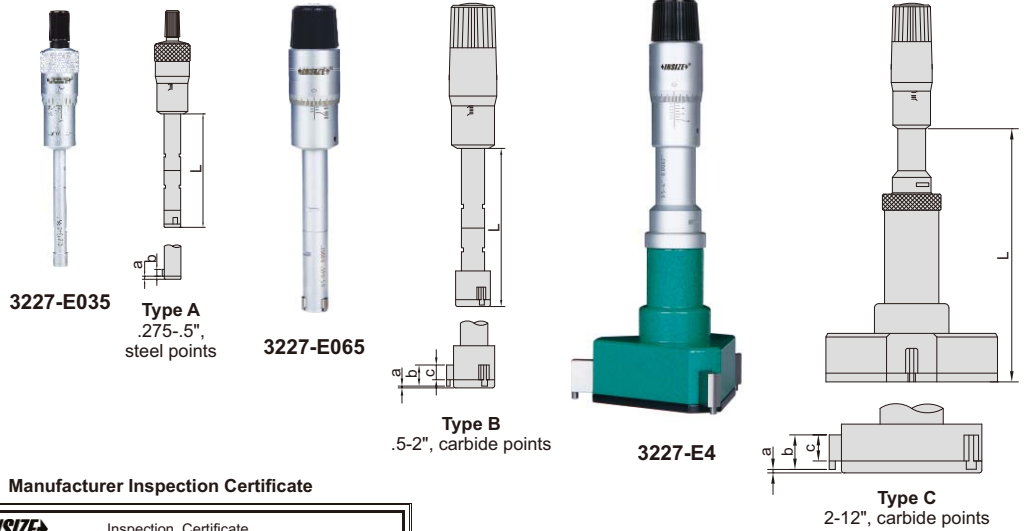

micrometer stand with clamp (optional)



#### Manufacturer Inspection Certificate

Actual Ring Sizes (inch)		Permissible Error	Measured Deviation
1.02360			0
1.10228	.00016		.00010
1.18107			.00019

#### Individual

Part No.	Range	Type	Accuracy	Setting ring	Extension rod (included)	L	a	b	c
3227-E035*	.275-.35"	A	.00016"	.275" DIA (included)	4"	2.146"	.059"	.098"	—
3227-E0425*	.35-.425"	A	.00016"	.35" DIA (included)	4"	2.146"	.059"	.098"	—
3227-E05*	.425-.5"	A	.00016"	.5" DIA (included)	4"	2.146"	.059"	.098"	—
3227-E065*	.5-.65"	B	.00016"	.65" DIA (included)	6"	3.150"	.020"	.236"	.177"
3227-E08*	.65-.8"	B	.00016"	.65" DIA (included)	6"	3.150"	.020"	.236"	.177"
3227-E1*	.8-1"	B	.00016"	1" DIA (included)	6"	3.543"	.020"	.315"	.236"
3227-E112*	1-1.2"	B	.00016"	1" DIA (included)	6"	3.543"	.020"	.315"	.236"
3227-E16*	1.2-1.6"	B	.00016"	1.6" DIA (included)	6"	3.819"	.020"	.551"	.472"
3227-E2*	1.6-2"	B	.00020"	1.6" DIA (included)	6"	3.819"	.020"	.551"	.472"
3227-E25*	2-2.5"	C	.00020"	2.5" DIA (included)	6"	4.488"	.020"	.689"	.571"
3227-E3*	2.5-3"	C	.00020"	2.5" DIA (included)	6"	4.488"	.020"	.689"	.571"
3227-E35*	3-3.5"	C	.00020"	3.5" DIA (included)	6"	4.488"	.020"	.689"	.571"
3227-E4*	3.5-4"	C	.00020"	3.5" DIA (included)	6"	4.488"	.020"	.689"	.571"
3227-E5*	4-5"	C	.00024"	(optional)	6"	5.512"	.035"	1.142"	.984"
3227-E6*	5-6"	C	.00024"	(optional)	6"	5.512"	.035"	1.142"	.984"
3227-E7*	6-7"	C	.00028"	(optional)	6"	5.512"	.035"	1.142"	.984"
3227-E8*	7-8"	C	.00028"	(optional)	6"	5.512"	.035"	1.142"	.984"
3227-E9	8-9"	C	.00032"	(optional)	6"	5.512"	.035"	1.142"	.984"
3227-E10	9-10"	C	.00032"	(optional)	6"	5.512"	.035"	1.142"	.984"
3227-E11	10-11"	C	.00036"	(optional)	6"	5.512"	.035"	1.142"	.984"
3227-E12	11-12"	C	.00036"	(optional)	6"	5.512"	.035"	1.142"	.984"

setting ring



.275-4": included  
4-12": optional

extension rod



included

#### Set

Part No.	Range	Micrometers included	Setting ring (included)	Extension rod (included)
3227-E053*	.275-.5"	.275-.35", .35-.425", .425-.5"	.275" DIA, .35" DIA, .5" DIA	4"
3227-E082*	.5-.8"	.5-.65", .65-.8"	.65" DIA	6"
3227-E24*	.8-2"	.8-1", 1-1.2", 1.2-1.6", 1.6-2"	1" DIA, 1.6" DIA	6"
3227-E44*	2-4"	2-2.5", 2.5-3", 3-3.5", 3.5-4"	2.5" DIA, 3.5" DIA	6"



3227-E24

\* Supplied with manufacturer inspection certificate

# ELECTRONIC THREE POINTS INTERNAL MICROMETERS

**IP54**  
WATERPROOF

**DATA**  
OUTPUT

**INSPECTION**  
CERTIFICATE

- Resolution .00005"/0.001mm
- IP54 dust/waterproof
- Buttons: on/off, set, inch/mm, ABS/INC
- Data output
- LR44 battery, automatic power off
- Ratchet stop
- Optional accessory:  
data output cable (part no. **7306-30A**,  
**7302-SPC6**, **7305-SPC3A**, **7305-B01**),  
setting ring (part no. **6313**),  
micrometer stand and clamp  
(part no. **6301** and **6301-2**)



**3127-E05**

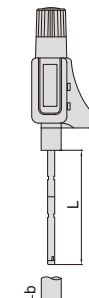

**Type A**  
.275-.5",  
steel points



**3127-E16**

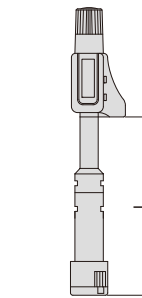

**Type B**  
.5-2", carbide points



**3127-E5**

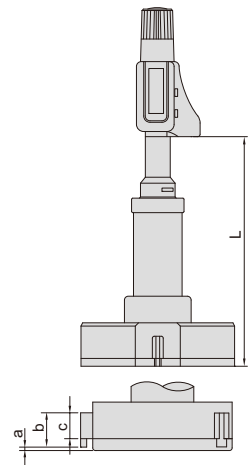

**Type C**  
2-12", carbide points

micrometer stand  
with clamp (optional)



### Manufacturer Inspection Certificate

INSIZE Inspection Certificate		
Product name	Electronic Three Points Internal Micrometer	Traceable to Germany 10339D-K-15015-01-02/2012-09
Code No.	3127-E12	Germany 31-02303KD-K-0001/2012-09
Measuring range	1-1.2"/25-30mm	Inspector <i>Paulo</i>
Resolution	.00005"/0.001mm	Judgement <i>Passed</i>
Serial No.	0910120004	
Standard temperature	68 °F	
Actual Ring Size(Inch)	Permissible Error	Measured Deviation
1.02360		.00005
1.10520	.00016	.00005
1.18107		.00010

### Individual

Part No.	Range	Type	Accuracy	Setting ring	Extension rod (included)	L	a	b	c
<b>3127-E035 *</b>	.275-.35"/7-9mm	A	.00016"	.275" DIA (included)	4"	2.18"	.059"	.098"	—
<b>3127-E0425 *</b>	.35-.425"/9-11mm	A	.00016"	.35" DIA (included)	4"	2.18"	.059"	.098"	—
<b>3127-E05 *</b>	.425-.5"/11-13mm	A	.00016"	.5" DIA (included)	4"	2.18"	.059"	.098"	—
<b>3127-E065 *</b>	.5-.65"/13-17mm	B	.00016"	.65" DIA (included)	6"	3.2"	.020"	.236"	.177"
<b>3127-E08 *</b>	.65-.8"/17-20mm	B	.00016"	.65" DIA (included)	6"	3.2"	.020"	.236"	.177"
<b>3127-E1 *</b>	.8-1"/20-25mm	B	.00016"	1" DIA (included)	6"	3.6"	.020"	.315"	.236"
<b>3127-E112 *</b>	1-1.2"/25-30mm	B	.00016"	1" DIA (included)	6"	3.6"	.020"	.315"	.236"
<b>3127-E16 *</b>	1.2-1.6"/30-40mm	B	.00016"	1.6" DIA (included)	6"	3.88"	.020"	.551"	.472"
<b>3127-E2 *</b>	1.6-2"/40-51mm	B	.00020"	1.6" DIA (included)	6"	3.88"	.020"	.551"	.472"
<b>3127-E25 *</b>	2-2.5"/51-63mm	C	.00020"	2.5" DIA (included)	6"	4.56"	.020"	.689"	.571"
<b>3127-E3 *</b>	2.5-3"/63-76mm	C	.00020"	2.5" DIA (included)	6"	4.56"	.020"	.689"	.571"
<b>3127-E35 *</b>	3-3.5"/76-89mm	C	.00020"	3.5" DIA (included)	6"	4.56"	.020"	.689"	.571"
<b>3127-E4 *</b>	3.5-4"/89-101mm	C	.00020"	3.5" DIA (included)	6"	4.56"	.020"	.689"	.571"
<b>3127-E5 *</b>	4-5"/101-127mm	C	.00024"	(optional)	6"	6"	.035"	1.142"	.984"
<b>3127-E6 *</b>	5-6"/127-152mm	C	.00024"	(optional)	6"	6"	.035"	1.142"	.984"
<b>3127-E7 *</b>	6-7"/152-178mm	C	.00028"	(optional)	6"	6"	.035"	1.142"	.984"
<b>3127-E8 *</b>	7-8"/178-203mm	C	.00028"	(optional)	6"	6"	.035"	1.142"	.984"
<b>3127-E9</b>	8-9"/203-228mm	C	.00032"	(optional)	6"	6"	.035"	1.142"	.984"
<b>3127-E10</b>	9-10"/228-254mm	C	.00032"	(optional)	6"	6"	.035"	1.142"	.984"
<b>3127-E11</b>	10-11"/254-279mm	C	.00036"	(optional)	6"	6"	.035"	1.142"	.984"
<b>3127-E12</b>	11-12"/279-305mm	C	.00036"	(optional)	6"	6"	.035"	1.142"	.984"

setting ring



.275-4": included  
4-12": optional

extension rod



included

### Set

Part No.	Range	Micrometers (included)	Setting ring (included)	Extension rod
<b>3127-E053 *</b>	.275-.5"/7-13mm	.275-.35"/7-9mm, .35-.425"/9-11mm, .425-.5"/11-13mm	.275" DIA, .35" DIA, .5" DIA	4" (included)
<b>3127-E082 *</b>	.5-.8"/13-20mm	.5-.65"/13-17mm, .65-.8"/17-20mm	.65" DIA	6" (included)
<b>3127-E24 *</b>	.8-2"/20-51mm	.8-1"/20-25mm, 1-1.2"/25-30mm, 1.2-1.6"/30-40mm, 1.6-2"/40-51mm	1" DIA, 1.6" DIA	6" (included)
<b>3127-E44 *</b>	2-4"/51-101mm	2-2.5"/51-63mm, 2.5-3"/63-76mm, 3-3.5"/76-89mm, 3.5-4"/89-101mm	2.5" DIA, 3.5" DIA	6" (included)



**3127-E24**

\* Supplied with manufacturer inspection certificate



## WIDE RANGE THREE POINTS INTERNAL MICROMETERS

- Graduation .0001"
- Carbide measuring faces
- Ratchet stop
- Setting rings are included (except part no. 3228-12)

Part No.	Range	Accuracy	Setting ring
3228-28*	2-2.8"	.00020"	2" DIA (included)
3228-4*	2.8-4"	.00020"	2.8" DIA (included)
3228-6*	4-6"	.00024"	4" DIA (included)
3228-10*	6-10"	.00032"	6" DIA (included)
3228-12*	8-12"	.00036"	8" DIA (optional)

\* Supplied with manufacturer inspection certificate



3228-28

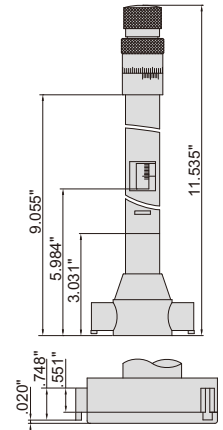

6



## ELECTRONIC WIDE RANGE THREE POINTS INTERNAL MICROMETERS

IP54  
WATERPROOF

DATA  
OUTPUT

- Resolution .00005"/0.001mm
- IP54 dust/waterproof
- Buttons: on/off, set, inch/mm, ABS/INC
- Data output
- LR44 battery, automatic power off
- Carbide measuring faces
- Ratchet stop
- Supplied with extension rods
- Setting rings are included (except part no. 3128-12)
- Optional accessory: data output cable (part no. 7306-30A, 7302-SPC6, 7305-SPC3A, 7305-B01)

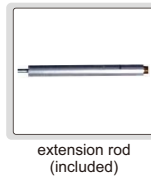

3128-28

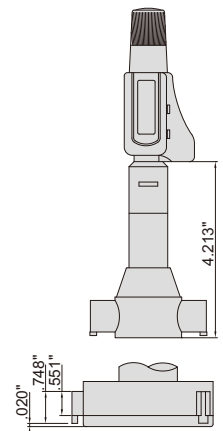

Part No.	Range	Accuracy	Setting ring	Extension rod (included)
3128-28*	2-2.8"/51-71mm	.00020"	2" DIA (included)	6"
3128-4*	2.8-4"/71-101mm	.00020"	2.8" DIA (included)	6"
3128-6*	4-6"/101-152mm	.00024"	4" DIA (included)	6"
3128-10*	6-10"/152-254mm	.00032"	6" DIA (included)	6"
3128-12*	8-12"/203-305mm	.00036"	8" DIA (optional)	6"

\* Supplied with manufacturer inspection certificate

## INSIDE MICROMETERS

- Graduation .001"
- Ratchet stop
- Carbide measuring faces
- Optional accessory: setting ring (part no. 6313), micrometer stand and clamp (part no. 6301 and 6301-1)



3220-2

micrometer stand with clamp (optional)

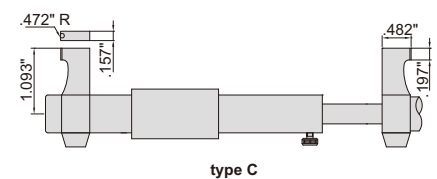
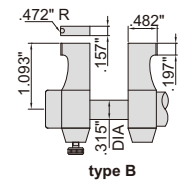
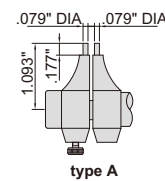

Part No.	Range	Type	Setting ring	Accuracy
3220-1	.2-1.2"	A	.2" DIA (included)	.00028"
3220-2	1-2"	B	1" DIA (included)	.00032"
3220-3	2-3"	B	2" DIA (optional)	.00036"
3220-4	3-4"	C	3" DIA (optional)	.00040"



## ELECTRONIC INSIDE MICROMETERS

DATA  
OUTPUT

- Resolution .00005"/0.001mm
- Button function: on/off, set, inch/mm, ABS/INC
- Data output
- LR44 battery, automatic power off
- Ratchet stop
- Carbide measuring faces
- Optional accessory: data output cable (part no. 7306-30A, 7302-SPC6, 7305-SPC3A, 7305-B01), setting ring (part no. 6313)



3520-30E

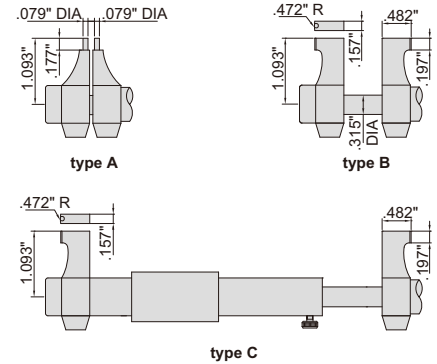

Part No.	Range	Type	Setting ring	Accuracy
3520-30E	.2-1.2"/5-30mm	A	.2" DIA (included)	±.00020"
3520-50E	1-2"/25-50mm	B	1" DIA (included)	±.00024"
3520-75E	2-3"/50-75mm	B	2" DIA (optional)	±.00028"
3520-100E	3-4"/75-100mm	C	3" DIA (optional)	±.00032"

6

## TUBULAR INSIDE MICROMETERS

- Graduation .001"
- Carbide measuring faces

Part No.	Range	Type	Accuracy
3229-3	2-3"	A	.00020"
3229-4	3-4"	B	.00020"
3229-5	4-5"	C	.00024"
3229-6	5-6"	C	.00024"
3229-7	6-7"	C	.00028"
3229-8	7-8"	C	.00028"
3229-9	8-9"	C	.00032"
3229-10	9-10"	C	.00032"
3229-11	10-11"	C	.00036"
3229-12	11-12"	C	.00036"
3229-13	12-13"	C	.00036"
3229-14	13-14"	C	.00036"
3229-15	14-15"	C	.00040"
3229-16	15-16"	C	.00040"
3229-17	16-17"	C	.00040"
3229-18	17-18"	C	.00040"
3229-19	18-19"	C	.00043"
3229-20	19-20"	C	.00043"



3229-7

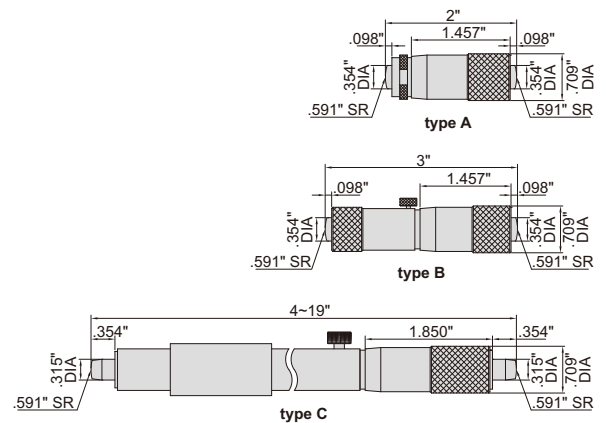

## TUBULAR INSIDE MICROMETERS

- Graduation .001"
- Accuracy: [.0003+.00005(L/2)]"  
L=maximum measuring length (inch)
- Optional accessory: setting ring (part no. 6313)

Part No.	Range	Travel of micrometer head	Extension rods
3221-125	1-1.25"	.25"	—
3221-2	1-2"	.25"	2 pcs
3221-25	2-2.5"	.5"	—
3221-8	2-8"	.5"	6 pcs
3221-12	2-12"	.5"	10 pcs
3221-9	8-9"	1"	—
3221-20	8-20"	1"	3 pcs
3221-40	8-40"	1"	8 pcs



3221-8

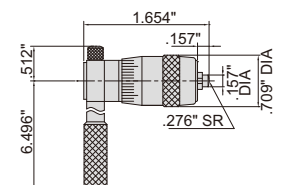



## TUBULAR INSIDE MICROMETERS

- Graduation .001"
- Accuracy:  $[\frac{.00005(3+n+L/2)}{1}]$ "  
n=number of rods,  
L=maximum measuring length (inch)
- Supplied with setting standards
- Carbide measuring faces

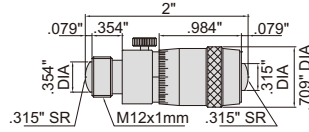

3222-6

Part No.	Range	Travel of micrometer head	Extension rods
3222-25	2-2.5"	.5"	—
3222-6	2-6"	.5"	.5", 1", 2"
3222-12	2-12"	.5"	.5", 1", 2" (2 pcs), 4"
3222-20	2-20"	.5"	.5", 1", 2" (2 pcs), 4", 8"
3222-24	2-24"	.5"	.5", 1", 2", 4", 6", 8"
3222-40	2-40"	.5"	.5", 1", 2" (2 pcs), 4", 8" (2 pcs), 12"
3222-60	2-60"	.5"	.5", 1", 2" (2 pcs), 4", 8" (3 pcs), 12" (2 pcs)

## TUBULAR INSIDE MICROMETERS

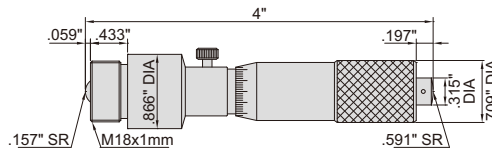

- Graduation .001"
- Accuracy:  $[\frac{.00005(3+n+L/2)}{1}]$ "  
n=number of rods,  
L=maximum measuring length (inch)
- Supplied with setting standards
- Carbide measuring faces



3225-20

Part No.	Range	Travel of micrometer head	Extension rods
3225-20	4-20"	1"	1", 2", 4", 8"
3225-36	4-36"	1"	1", 2", 4", 8", 16"
3225-52	4-52"	1"	1", 2", 4", 8", 16" (2 pcs)
3225-84	4-84"	1"	1", 2", 4", 8", 16" (4 pcs)

## TUBULAR INSIDE MICROMETERS



3224-80

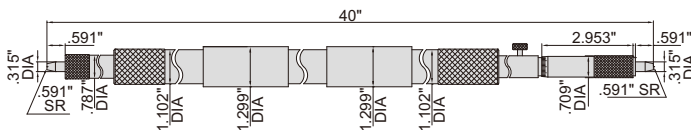

Part No.	Range	Travel of micrometer head	Extension rods
3224-80	40-80"	2"	2", 4" (2 pcs), 8", 20"
3224-120	40-120"	2"	2", 4" (2 pcs), 8", 20", 40"
3224-160	40-160"	2"	2", 4" (2 pcs), 8", 20", 40" (2 pcs)
3224-200	40-200"	2"	2", 4" (2 pcs), 8", 20", 40" (3 pcs)

- Graduation .001"
- Accuracy:  $[\frac{.00005(7+n+L/2)}{1}]$ "  
n=number of rods,  
L=maximum measuring length (inch)
- Carbide measuring faces

# BORE PLUG GAGES

**INSIZE PLUS**  
MADE IN GERMANY

principle of measurement

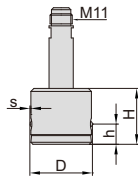
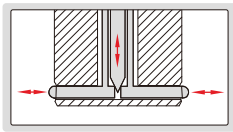

6

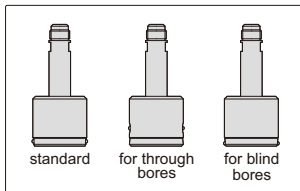

## SPECIFICATION OF PROBE

Range	.079-.118"	.122-.157"	.161-.236"	.240-.354"	.358-.472"	.476-.787"	.791-1.575"	1.579-2.362"	2.366-5.118"
Travel of point (s)	.006"	.006"	.006"	.008"	.008"	.008"	.008"	.008"	.008"
Height of point (h)	standard	.039"	.059"	.098"	.098"	.098"	.138"	.138"	.157"
	for through bores	—	.236"	.236"	.236"	.394"	.394"	.394"	.394"
	for blind bores	.028"	.039"	.039"	.039"	.039"	.047"	.047"	.047"
Height of probe (H)	.689"	1.024"	.394"	.591"	.591"	.591"	.787"	1.102"	1.299"
Repeatability	40µin	40µin	40µin	20µin	20µin	20µin	20µin	20µin	40µin

## PROBE

Part No.	Type
4653-A□□□□	standard
4653-B□□□□	for through bores
4653-C□□□□	for blind bores



## DEPTH STOP

Part No.	Applicable for probe
4653-G□□□□	.118-2.362"

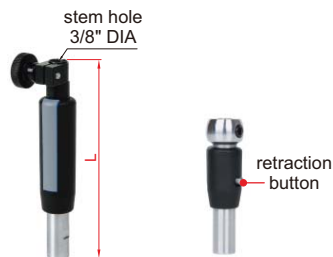

## SETTING RING

Part No.
6313-□□□□□



## HANDLE

Part No.	Length (L)	Retraction
4653-E150	1.772"	without
4653-E1105	4.134"	without
4653-E1235	9.252"	without
4653-EH70	2.756"	with

## HANDLE EXTENSION

Part No.	Length (H)
4653-R50	1.969"
4653-R100	3.937"
4653-R250	9.843"
4653-R500	19.685"

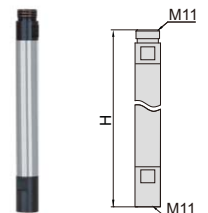

## SPLIT TYPE DIAL BORE GAGE SETS

**INSIZE PLUS**  
MADE IN GERMANY

- Split type contact points
- Accuracy (without dial indicator):  
118µin (measuring range .163"~.394"),  
157µin (measuring range .394"~.811")
- Repeatability (without dial indicator) .39µin
- Setting rings and dial indicators  
(graduation .001" or .0001" or .00005") are optional



2421-E121

principle of measurement

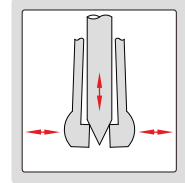

Part No.	Range	Quantity of points	Measuring range of point	Measuring depth (L1)	Total length (L)	Material of point	Type of point	Setting ring (optional)	
								Part No.	Diameter
2421-E1D4	.037-.061"	5	.037-.045"	.512"	3.504"	carbide tip	A	6313-0D041	.041"
			.042-.049"	.512"	3.504"	carbide tip	A	6313-0D046	.046"
			.046-.053"	.512"	3.504"	carbide tip	A	6313-0D050	.050"
			.050-.057"	.512"	3.504"	carbide tip	A	6313-0D054	.054"
			.054-.061"	.512"	3.504"	carbide tip	A	6313-0D058	.058"
2421-E4	.059-.165"	10	.059-.075"	.669"	3.661"	carbide tip	A	6313-0D067	.067"
			.071-.087"	.669"	3.661"	carbide tip	A	6313-0D079	.079"
			.081-.096"	.669"	3.661"	carbide tip	A	6313-0D089	.089"
			.091-.106"	.984"	3.976"	carbide tip	A	6313-0D099	.099"
			.100-.116"	.984"	3.976"	carbide tip	A	6313-0D108	.108"
			.110-.126"	.984"	3.976"	carbide tip	A	6313-0D118	.118"
			.120-.136"	.984"	3.976"	carbide tip	A	6313-0D128	.128"
			.130-.146"	.984"	3.976"	carbide tip	A	6313-0D138	.138"
			.140-.156"	.984"	3.976"	carbide tip	A	6313-0D148	.148"
			.150-.165"	.984"	3.976"	carbide tip	A	6313-0D158	.158"
2421-E7D5	.163-.307"	7	.163-.189"	1.614"	4.646"	hard chromed	B	6313-0D176	.176"
			.185-.209"	1.614"	4.646"	hard chromed	B	6313-0D197	.197"
			.205-.228"	1.614"	4.646"	hard chromed	B	6313-0D217	.217"
			.224-.248"	1.614"	4.646"	hard chromed	B	6313-0D236	.236"
			.244-.268"	1.614"	4.646"	hard chromed	B	6313-0D256	.256"
			.264-.287"	1.614"	4.646"	hard chromed	B	6313-0D276	.276"
			.283-.307"	1.614"	4.646"	hard chromed	C	6313-0D295	.295"
2421-E12	.303-.492"	6	.303-.327"	1.772"	4.646"	hard chromed	C	6313-0D315	.315"
			.323-.346"	1.772"	4.646"	hard chromed	C	6313-0D335	.335"
			.343-.366"	1.772"	4.646"	hard chromed	C	6313-0D355	.355"
			.362-.413"	1.772"	4.646"	hard chromed	C	6313-0D388	.388"
			.402-.453"	1.772"	4.646"	hard chromed	C	6313-0D428	.428"
			.441-.492"	1.772"	4.646"	hard chromed	C	6313-0D467	.467"
2421-E20	.480-.811"	8	.480-.531"	1.772"	4.646"	hard chromed	C	6313-0D506	.506"
			.528-.575"	1.772"	4.646"	hard chromed	C	6313-0D552	.552"
			.567-.614"	1.772"	4.646"	hard chromed	C	6313-0D591	.591"
			.606-.654"	1.772"	4.646"	hard chromed	C	6313-0D630	.630"
			.646-.693"	1.772"	4.646"	hard chromed	C	6313-0D670	.670"
			.685-.732"	1.772"	4.646"	hard chromed	C	6313-0D709	.709"
			.724-.772"	1.772"	4.646"	hard chromed	C	6313-0D748	.748"
			.764-.811"	1.772"	4.646"	hard chromed	C	6313-0D788	.788"
2421-E121	.163-.492"	13	.163-.189"	1.614"	4.646"	hard chromed	B	6313-0D176	.176"
			.185-.209"	1.614"	4.646"	hard chromed	B	6313-0D197	.197"
			.205-.228"	1.614"	4.646"	hard chromed	B	6313-0D217	.217"
			.224-.248"	1.614"	4.646"	hard chromed	B	6313-0D236	.236"
			.244-.268"	1.614"	4.646"	hard chromed	B	6313-0D256	.256"
			.264-.287"	1.614"	4.646"	hard chromed	B	6313-0D276	.276"
			.283-.307"	1.772"	4.646"	hard chromed	C	6313-0D295	.295"
			.303-.327"	1.772"	4.646"	hard chromed	C	6313-0D315	.315"
			.323-.346"	1.772"	4.646"	hard chromed	C	6313-0D335	.335"
			.343-.366"	1.772"	4.646"	hard chromed	C	6313-0D355	.355"
			.362-.413"	1.772"	4.646"	hard chromed	C	6313-0D388	.388"
			.402-.453"	1.772"	4.646"	hard chromed	C	6313-0D428	.428"
			.441-.492"	1.772"	4.646"	hard chromed	C	6313-0D467	.467"

dial indicator is not included

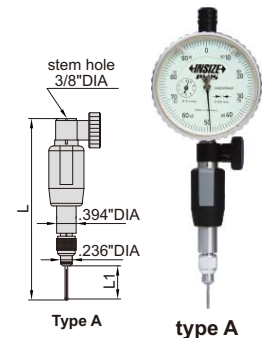

Type A

type A

dial indicator is not included

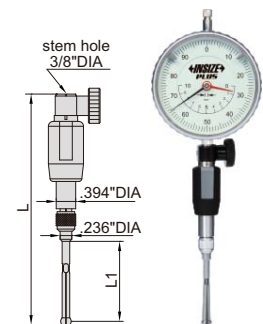

Type B

type B

dial indicator is not included

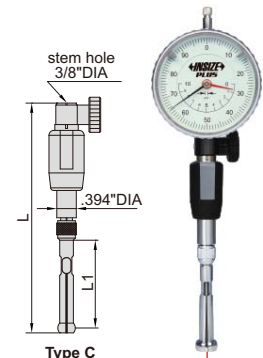

Type C

contact point

type C



## BORE GAGES FOR SMALL HOLES

**INSIZE PLUS**  
MADE IN GERMANY

- Applicable for .001" or .0001" or .00005" graduation dial indicators
- Carbide contact point and anvil
- Optional accessory: dial indicator or dial comparator, setting ring (part no. 6313)

Part No.	Range	Accuracy (without dial comparator)	Repeatability (without dial comparator)	L1	L2	R (DIA)	D (DIA)	h
2425-E6	.18-.24"	79µin	20µin	3.150"	5.787"	.157"	.157"	.079"
2425-E8	.24-.32"	79µin	20µin	3.937"	6.496"	.197"	.205"	.102"
2425-E12	.32-.47"	79µin	20µin	3.937"	6.535"	.197"	.256"	.128"
2425-E20	.47-.79"	79µin	20µin	4.331"	8.031"	.315"	.354"	.177"

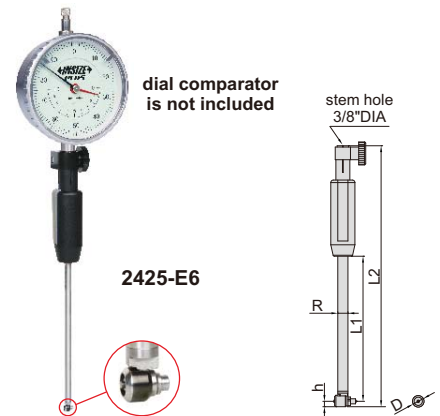

2425-E6

6

## BORE GAGES

**INSIZE PLUS**  
MADE IN GERMANY

- Applicable for .001" or .0001" or .00005" graduation dial indicators
- Optional accessory:
  - Dial indicator or dial comparator
  - Setting ring (part no. 6313)
  - Long handle (part no. 7352)

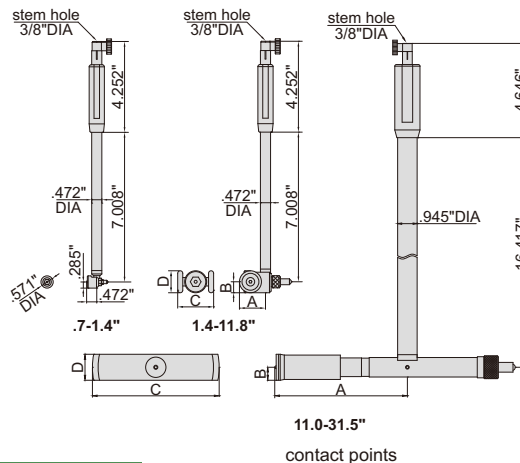

2422-E150

Part No.	Range	Accuracy (without dial comparator)	Repeatability (without dial comparator)
2422-E35	.7-1.4"	157µin	79µin
2422-E60	1.4-2.4"	157µin	79µin
2422-E150	2.0-5.9"	157µin	79µin
2422-E300	5.9-11.8"	157µin	79µin
2422-E510	11.0-20.1"	118µin	59µin
2422-E800	15.7-31.5"	118µin	59µin



Range	A	B	C	D (DIA)
1.4-2.4"	.768"	.413"	1.102"	.827"
2.0-5.9"	1.213"	.512"	1.673"	1.024"
5.9-11.8"	1.213"	.512"	3.012"	1.024"
11.0-20.1"	6.457"	.630"	6.142"	1.260"
15.7-31.5"	12.008"	.709"	11.811"	1.417"

## BORE GAGE SET

**INSIZE PLUS**  
MADE IN GERMANY



2423-ES2

- Includes bore gages .7-2.0" and 2.0-5.9"
- Optional accessory:
  - Dial indicator (graduation .001" or .0001" or .00005")
  - Setting ring (part no. 6313)
  - Long handle (part no. 7352)

dial comparator is not included

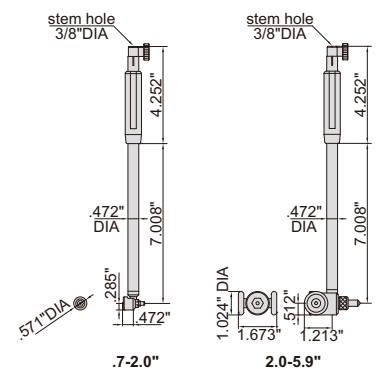

Part No.	Range	Accuracy (without dial comparator)	Repeatability (without dial comparator)
2423-ES2	.7-5.9"	157µin	79µin

ATTENTION: NOT SUITABLE FOR .00005" OR .0001" DIAL INDICATORS



Read the diameter directly, after inputting the size of setting ring.



The minimum value tracking function can find the diameter automatically.

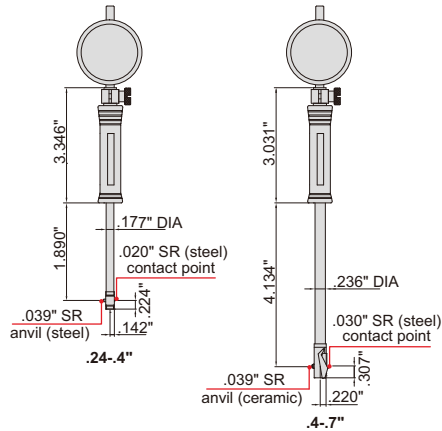
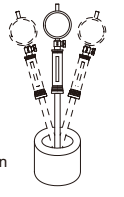

DATA OUTPUT

2323-04



2123-07A

Optional accessory: setting ring (part no. 6313)

With dial indicator

Part No.	Range	Indicator	Accuracy	Repeatability
2323-04	.24-.4"	dial indicator, range .25", graduation .0005"	±.00075"	.00015"
2323-07	.4-.7"		±.00075"	.00015"

With electronic indicator

Part No.	Range	Indicator	Accuracy	Repeatability
2123-04A	.24-.4"	electronic indicator, range .5"/12.7mm, resolution .0001"/0.002mm	±.00075"	.0001"
2123-07A	.4-.7"		±.00075"	.0001"

ATTENTION: NOT SUITABLE FOR .00005" OR .0001" DIAL INDICATORS

Optional accessory: setting ring (part no. 6313), long handle (part no. 7351)

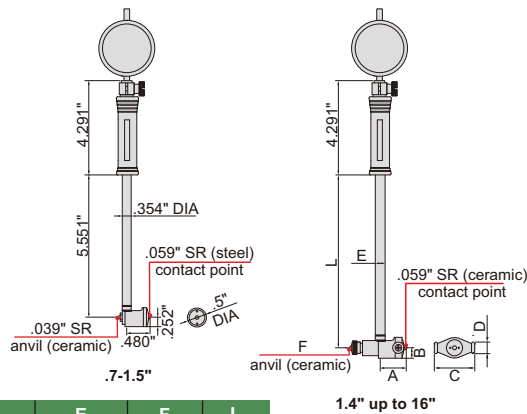

Range	A	B	C	D	E	F	L
1.4-2.4"	.866"	.354"	1.063"	.512" DIA	.504" DIA	.079" R	5.551"
2-6"	1.024"	.354"	1.378"	.512" DIA	.504" DIA	.079" R	5.551"
6-10"	2.224"	.512"	2.933"	.591" DIA	.571" DIA	.079" R	9.488"
10-16"	3.406"	.591"	3.996"	.591" DIA	.571" DIA	.098" R	9.488"

With dial indicator

Part No.	Range	Indicator	Accuracy	Repeatability
2323-15	.7-1.5"	dial indicator, range .25", graduation .0005"	±.00075"	.00015"
2323-24	1.4-2.4"		±.0009"	.00015"
2323-6	2-6"		±.0009"	.00015"
2323-10	6-10"		±.0009"	.00015"
2323-16	10-16"		±.0009"	.00015"

With electronic indicator

Part No.	Range	Indicator	Accuracy	Repeatability
2123-15A	.7-1.5"	electronic indicator, range .5"/12.7mm, resolution .0001"/0.002mm	±.00075"	.0001"
2123-24A	1.4-2.4"		±.0009"	.0001"
2123-6A	2-6"		±.0009"	.0001"
2123-10A	6-10"		±.0009"	.0001"
2123-16A	10-16"		±.0009"	.0001"

BORE GAGES

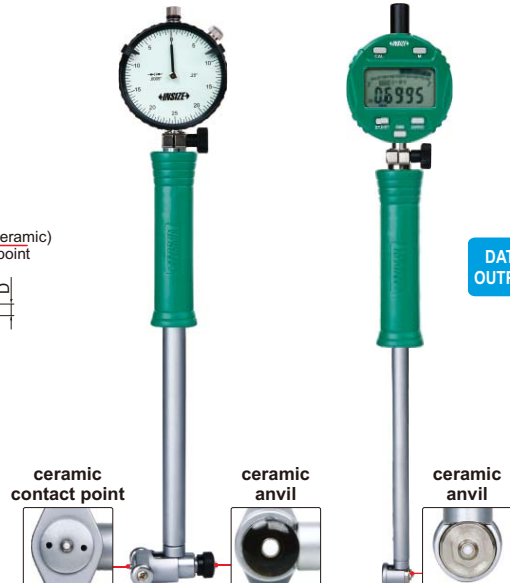

DATA OUTPUT

2323-6

2123-15A

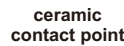

Read the diameter directly, after inputting the size of setting ring.

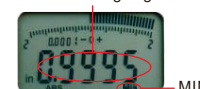

The minimum value tracking function can find the diameter automatically.

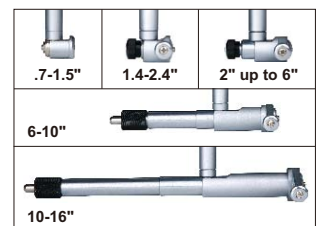
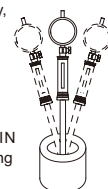

## BORE GAGE SETS

Optional accessory: setting ring (part no. 6313)



ATTENTION: NOT SUITABLE FOR .00005" OR .0001" DIAL INDICATORS

packaging (part no. 2824-S3E)



Part No.	Range	Indicator	Bore gages included	Accuracy	Repeatability
2824-S2E	1.4-6"	dial indicator range .25", graduation .0005"	① 1.4-2" (dial indicator and handle are not included) ② 2-6"	1.4-2" ±.0009" 2-6" ±.0009"	.00015"
2824-S3E	.7-6"	dial indicator range .25", graduation .0005"	① .7-1.5" ② 1.4-2.4" (dial indicator is not included) ③ 2-6" (dial indicator is not included)	.7-1.5" ±.00075" 1.4-2.4" ±.0009" 2-6" ±.0009"	.00015"

## BORE GAGES

ATTENTION: NOT SUITABLE FOR .00005" OR .0001" DIAL INDICATORS

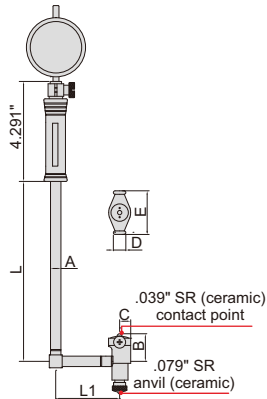

Optional accessory: setting ring (part no. 6313)

Range	A (DIA)	B	C	D (DIA)	E	L	L1
2-6"	.504"	1.122"	.362"	.512"	1.378"	5.551"	3.000"
6-10"	.571"	2.441"	.500"	.591"	2.933"	15.394"	3.937"
10-16"	.571"	3.602"	.591"	.591"	3.996"	15.394"	3.937"

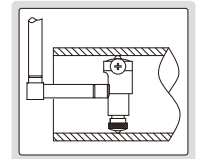

Part No.	Range	Indicator	Accuracy	Repeatability
2827-6	2-6"	dial indicator range .25", graduation .0005"	±.0009"	.00015"
2827-10	6-10"		±.0009"	.00015"
2827-16	10-16"		±.0009"	.00015"

## BORE GAGE

ATTENTION: NOT SUITABLE FOR .00005" OR .0001" DIAL INDICATORS

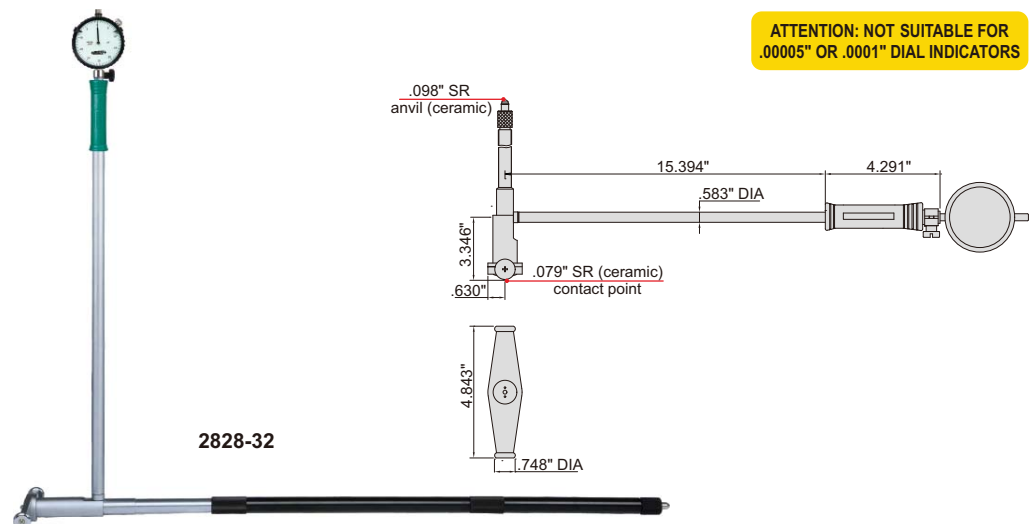

Part No.	Range	Indicator	Accuracy	Repeatability
2828-32	16-32"	dial indicator, range .25", graduation .0005"	±.001"	.00015"

## LONG HANDLES

- To assist deep-hole measurement
- Can be used for bore gages 2323, 2123, 2824 and 2827

Part No.	Applicable bore gages	A	D	Type
7351-1EX11	1.4-2.4", 2-6"	18.7"	.512" DIA	B
7351-1EX12		38.5"	.512" DIA	A
7351-1EX13		58.2"	.571" DIA	
7351-1EX14		77.8"	.571" DIA	
7351-1EX21	6-10", 10-16"	18.7"	.571" DIA	B
7351-1EX22		38.5"	.571" DIA	A
7351-1EX23		58.2"	.571" DIA	
7351-1EX24		77.8"	.571" DIA	

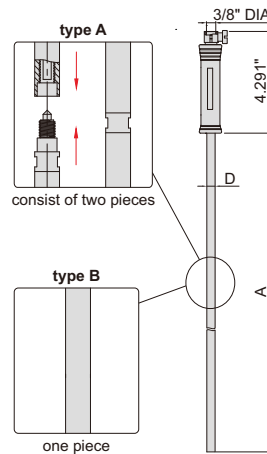

7351-1EX11

method of use (replace the original handle with long handle)

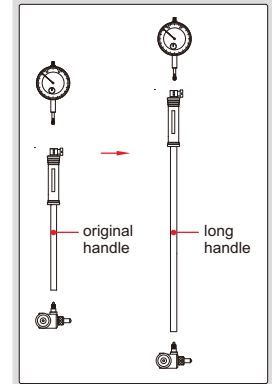

## ANVILS FOR BORE GAGES



7350-E6

- For 2323, 2123, 2827

Part No.	Applicable bore gages	Material of measuring face	Quantity per set	Measuring range of anvil
7350-E04	.24-.4"	steel	9 pcs	.24", .26", .28", .3", .32", .34", .36", .38", .4"
7350-E07	.4-.7"	ceramic	9 pcs	.4", .44", .48", .52", .58", .62", .64", .68", .7"
7350-E15	.7-1.5"	ceramic	10 pcs	.7", .78", .86", .94", 1.02", 1.1", 1.18", 1.26", 1.34", 1.42"
7350-E24	1.4-2.4"	ceramic	6 pcs	1.4", 1.6", 1.8", 2", 2.2", 2.4"
7350-E6	2-6"	ceramic	11 pcs	2", 2.2", 2.4", 2.6", 2.8", 3", 3.2", 3.4", 3.6", 3.8", 4"
7350-E10	6-10"	ceramic	6 pcs	6", 6.4", 6.8", 7.2", 7.6", 8"
7350-E16	10-16"	ceramic	6 pcs	10", 10.4", 10.8", 11.2", 11.6", 12"

## BORE GAGE SETTER

- Used together with gage blocks to set bore gages

Part No.	Setting range
2395-400	.7-16"

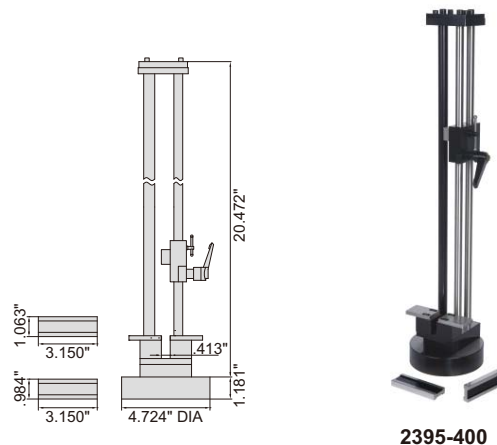

2395-400

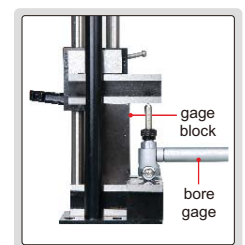



## SETTING RINGS

- For zero setting of inside micrometers, three points internal micrometers and bore gages
- Deviation is the difference between the ordered size and the size marked on the setting ring when supplied. For example, the ordered size is .2", the size marked on the setting ring when supplied may be .20008"

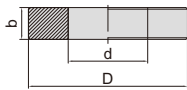

1.588-3.937" DIA

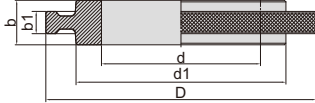

3.937-12" DIA



ACCURACY: CLASS XX  
OF ASME B89.1.6

CAN SUPPLY CUSTOM SETTING RINGS  
FROM 1/16" TO 12", FOR EXAMPLE, .6726"



6313-0D8

Product name		Setting Ring	
Code No.	6313-0D8	Marked Size	0.69953
Serial No.	2005-149296	Diameter	at 0° at 90°
Standard temperature	68 °F	Top	0.69991 0.69994
Traceable to	10339D-K-15015-01-02/2012-09	Middle	0.69991 0.69994
Judgement	Pass	Bottom	0.69993 0.69994
Inspector	S. Yang	Average	0.69993
		Cylindricity	0.00002
		Roundness	0.00003

6

Diameter d	b	D	Deviation	Roundness and cylindricity
.059-.098"	.157"	.866"	±.00006"	.000012"
.098-.118"	.197"	.866"	±.00008"	.000016"
.118-.197"	.197"	.866"	±.00008"	.000016"
.197-.394"	.315"	1.260"	±.00008"	.000016"
.394-.591"	.394"	1.496"	±.00010"	.000020"
.591-.709"	.472"	1.772"	±.00010"	.000020"
.709-.787"	.472"	1.772"	±.00012"	.000024"
.787-.984"	.551"	2.087"	±.00012"	.000024"
.984-1.181"	.630"	2.480"	±.00014"	.000028"
1.181-1.260"	.630"	2.480"	±.00014"	.000028"
1.260-1.575"	.709"	2.795"	±.00014"	.000028"
1.575-1.969"	.787"	3.346"	±.00014"	.000028"
1.969-2.362"	.787"	3.937"	±.00016"	.000032"
2.362-2.756"	.945"	4.409"	±.00016"	.000032"
2.756-3.150"	.945"	4.921"	±.00016"	.000032"
3.150-3.543"	.945"	5.512"	±.00016"	.000040"
3.543-3.937"	.945"	6.300"	±.00016"	.000040"

\* For example .709-.787" means .709" DIA < diameters ≤ .787" DIA

Diameter d	b	b1	d1	D	Deviation	Roundness and cylindricity
3.937-4.331"	1.102"	.551"	5.197"	6.693"	±.00020"	.000040"
4.331-4.724"	1.102"	.630"	5.512"	7.087"	±.00020"	.000040"
4.724-5.118"	1.102"	.630"	5.906"	7.480"	±.00024"	.000047"
5.118-5.512"	1.102"	.709"	6.299"	7.874"	±.00024"	.000047"
5.512-5.906"	1.102"	.709"	6.693"	8.346"	±.00024"	.000047"
5.906-6.299"	1.102"	.787"	7.087"	8.819"	±.00024"	.000047"
6.299-6.693"	1.260"	.787"	7.480"	9.291"	±.00024"	.000047"
6.693-7.087"	1.260"	.787"	7.874"	9.843"	±.00024"	.000047"
7.087-7.480"	1.260"	.866"	8.346"	10.433"	±.00028"	.000055"
7.480-7.874"	1.260"	.866"	8.819"	11.024"	±.00028"	.000055"
7.874-8.346"	1.260"	.866"	9.291"	11.811"	±.00028"	.000055"
8.346-8.819"	1.260"	.984"	9.843"	12.402"	±.00028"	.000055"
8.819-9.291"	1.417"	.984"	10.433"	13.189"	±.00028"	.000055"
9.291-9.843"	1.417"	1.102"	11.024"	13.976"	±.00028"	.000055"
9.843-10.433"	1.417"	1.102"	11.811"	14.764"	±.00032"	.000063"
10.433-11.024"	1.417"	1.102"	12.402"	15.748"	±.00032"	.000063"
11.024-11.811"	1.417"	1.260"	13.189"	16.732"	±.00032"	.000063"
11.811-12.402"	1.417"	1.260"	13.976"	17.717"	±.00032"	.000063"

Part No.	Diameter	Part No.	Diameter	Part No.	Diameter	Part No.	Diameter	Part No.	Diameter
6313-1H16 *	1/16" DIA	6313-1H2 *	1/2" DIA	6313-15H16 *	15/16" DIA	6313-1D4 *	1.4" DIA	6313-5D5 *	5.5" DIA
6313-3H32 *	3/32" DIA	6313-17H32 *	17/32" DIA	6313-31H32 *	31/32" DIA	6313-1D6 *	1.6" DIA	6313-6 *	6.0" DIA
6313-1H8 *	1/8" DIA	6313-9H16 *	9/16" DIA	6313-0D1 *	.1" DIA	6313-1D8 *	1.8" DIA	6313-6D5 *	6.5" DIA
6313-5H32 *	5/32" DIA	6313-19H32 *	19/32" DIA	6313-0D16 *	.16" DIA	6313-2 *	2.0" DIA	6313-7 *	7.0" DIA
6313-3H16 *	3/16" DIA	6313-5H8 *	5/8" DIA	6313-0D24 *	.24" DIA	6313-2D4 *	2.4" DIA	6313-7D5 *	7.5" DIA
6313-7H32 *	7/32" DIA	6313-21H32 *	21/32" DIA	6313-0D275 *	.275" DIA	6313-2D5 *	2.5" DIA	6313-8 *	8.0" DIA
6313-1H4 *	1/4" DIA	6313-11H16 *	11/16" DIA	6313-0D35 *	.35" DIA	6313-2D8 *	2.8" DIA	6313-8D5 *	8.5" DIA
6313-9H32 *	9/32" DIA	6313-23H32 *	23/32" DIA	6313-0D425 *	.425" DIA	6313-3 *	3.0" DIA	6313-9 *	9.0" DIA
6313-5H16 *	5/16" DIA	6313-3H4 *	3/4" DIA	6313-0D6 *	.6" DIA	6313-3D2 *	3.2" DIA	6313-9D5 *	9.5" DIA
6313-11H32 *	11/32" DIA	6313-25H32 *	25/32" DIA	6313-0D65 *	.65" DIA	6313-3D5 *	3.5" DIA	6313-10 *	10.0" DIA
6313-3H8 *	3/8" DIA	6313-13H16 *	13/16" DIA	6313-0D7 *	.7" DIA	6313-3D6 *	3.6" DIA	6313-10D5 *	10.5" DIA
6313-13H32 *	13/32" DIA	6313-27H32 *	27/32" DIA	6313-0D8 *	.8" DIA	6313-4 *	4.0" DIA	6313-11 *	11.0" DIA
6313-7H16 *	7/16" DIA	6313-7H8 *	7/8" DIA	6313-1 *	1.0" DIA	6313-4D5 *	4.5" DIA	6313-11D5 *	11.5" DIA
6313-15H32 *	15/32" DIA	6313-29H32 *	29/32" DIA	6313-1D2 *	1.2" DIA	6313-5 *	5.0" DIA	6313-12 *	12.0" DIA

\* Supplied with manufacturer inspection certificate

## SMALL HOLE GAGE SET

- 4 gages per set
- For small holes, slots and grooves, etc.
- Satin chrome finish



4208-1

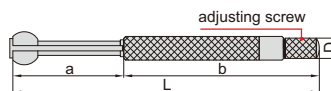

Part No.	Total range	Gages included
4208-1	.125~.5"	.125~.2", .2~.3", .3~.4", .4~.5"

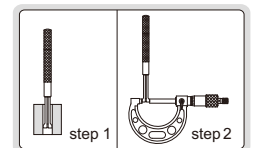

Range	L	a	b	D
.125~.2"	2.992"	.945"	2.047"	.197" DIA
.2~.3"	3.110"	1.063"	2.047"	.197" DIA
.3~.4"	3.465"	1.181"	2.283"	.236" DIA
.4~.5"	3.583"	1.339"	2.283"	.236" DIA

## TELESCOPING GAGE SET

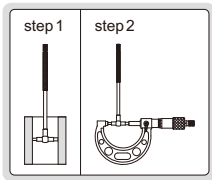

4206-1

- 6 gages per set
- For quick measurement of inside diameter of holes and width of slots
- Satin chrome finish

Range	L	a (DIA)	b (DIA)	c (DIA)
5/16~1/2"	4.528"	.154"	.114"	.244"
1/2~3/4"	4.528"	.209"	.150"	.244"
3/4~1-1/4"	4.528"	.209"	.150"	.244"
1-1/4~2-1/8"	5.394"	.299"	.240"	.283"
2-1/8~3-1/2"	5.394"	.299"	.240"	.283"
3-1/2~6"	5.394"	.299"	.240"	.283"

Part No.	Total range	Gages included
4206-1	5/16~6"	5/16~1/2", 1/2~3/4", 3/4~1-1/4", 1-1/4~2-1/8", 2-1/8~3-1/2", 3-1/2~6"

6

## LONG HANDLE TELESCOPING GAGES

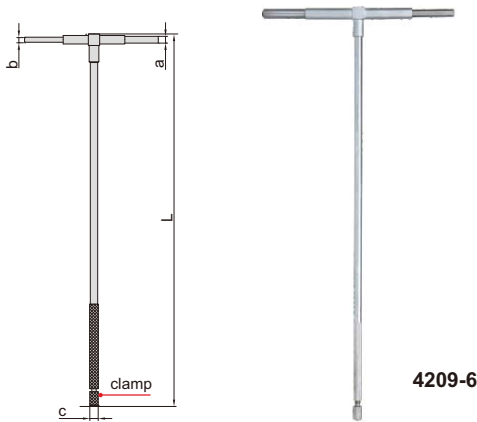
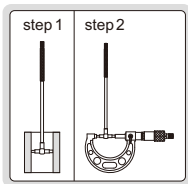

4209-6

- For quick measurement of inside diameter of deep holes and width of slots
- Satin chrome finish

Part No.	Range	L	a (DIA)	b (DIA)	c (DIA)
4209-1	5/16~1/2"	9.843"	.154"	.114"	.244"
4209-2	1/2~3/4"	9.843"	.209"	.150"	.244"
4209-3	3/4~1-1/4"	9.843"	.209"	.150"	.244"
4209-4	1-1/4~2-1/8"	11.811"	.299"	.240"	.283"
4209-5	2-1/8~3-1/2"	11.811"	.299"	.240"	.283"
4209-6	3-1/2~6"	11.811"	.299"	.240"	.283"

DATA OUTPUT

measure end diameter of chamfer or taper holes

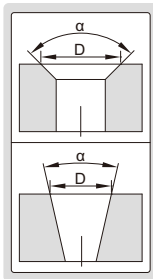
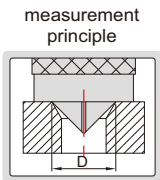

2942-20

## ELECTRONIC INTERNAL CHAMFER GAGES

**INSIZE PLUS**  
MADE IN GERMANY

- Measure end diameter of chamfer or taper holes
- Resolution .0005"/0.01mm

Part No.	Range D	Applicable angle $\alpha$	Accuracy	d (DIA)
2942-20	.020-.791"	0-90°	±.0008"	1.114"
2942-40	.787-1.575"	0-90°	±.0008"	1.969"
2942-203	.020-.791"	90-127°	±.0012"	1.114"
2942-403	.787-1.575"	90-127°	±.0012"	1.969"

## ELECTRONIC RADIUS GAGE

ATTENTION: NO DATA OUTPUT

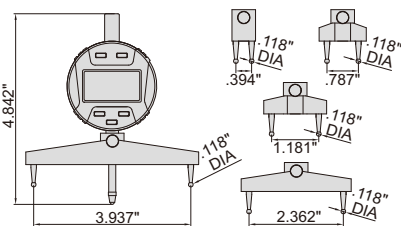

- Resolution .00005"/0.005mm
- Buttons: on/off, hold, inch/mm, s (select jaws), zero
- Measure radius of internal or external arcs
- Display can be rotated by 320°
- Supplied with 5 jaws for different sizes of arc
- Battery CR2032, automatic power off



2183

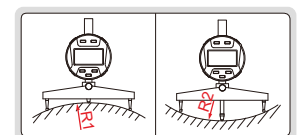

Part No.	Range of external radius (R1)	Range of internal radius (R2)	Accuracy (inch)
2183	.2-35.83"/5-910mm	.3-35.83"/7-910mm	±0.01R*

\* R is the radius to be measured

## COMPACT ELECTRONIC INDICATORS

- Meet ASME B89.1.10M-2001
- Button function:
  - in/mm: short press for inch/metric conversion
  - long press to change measuring direction
- ABS: short press for absolute/incremental measurement
- long press to preset data
- 0/O.N: short press to turn on when power is off
- short press to set zero when power is on
- long press to turn off
- Keep preset data in memory after restart
- CR1632 battery, automatic power off
- Data output
- With flat back
- Optional accessory: data output cable (part no. 7306-40, 7302-SPC3A, 7305-SPC1A, 7305-C01), contact points (page 73)



2114-51FE

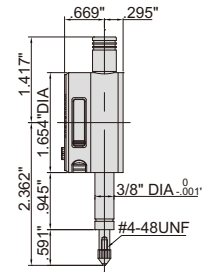

**INSPECTION CERTIFICATE**  
TRACEABLE TO NIST

DATA OUTPUT

Part No.	Range	Resolution	Accuracy	Hysteresis
2114-5FE*	.2"/5mm	.0005"/0.01mm	±.0015"	.0005"
2114-51FE*	.2"/5mm	.00005"/0.001mm	±.00015"	.00005"

\* Supplied with manufacturer inspection certificate traceable to NIST

## ELECTRONIC INDICATORS (STANDARD MODEL)

DATA OUTPUT

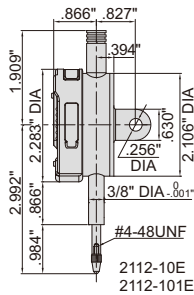

2112-10E

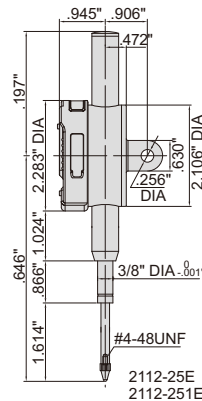

2112-251E

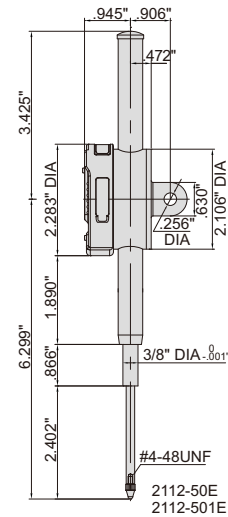

2112-501E

- Meet ASME B89.1.10M-2001
- Button function: on/off, inch/mm, zero
- CR2032 battery, automatic power off
- Data output
- With lug back
- Optional accessory: data output cable (part no. 7306-40, 7302-SPC3A, 7305-SPC1A, 7305-C01), backs (page 74), contact points (page 73)

spindle lift knob is included



Resolution .00005"/0.001mm

Part No.	Range	Accuracy	Hysteresis
2112-101E*	.5"/12.7mm	±.00015"	.00005"
2112-251E*	1"/25.4mm	±.00015"	.00005"
2112-501E*	2"/50.8mm	±.00015"	.00005"

Resolution .0005"/0.01mm

Part No.	Range	Accuracy	Hysteresis
2112-10E*	.5"/12.7mm	±.0015"	.0005"
2112-25E*	1"/25.4mm	±.0015"	.0005"
2112-50E*	2"/50.8mm	±.0015"	.0005"

\* Supplied with manufacturer inspection certificate traceable to NIST

## MANUFACTURER INSPECTION CERTIFICATE TRACEABLE TO NIST, FOR DIAL INDICATORS ELECTRONIC INDICATORS AND DIAL TEST INDICATORS

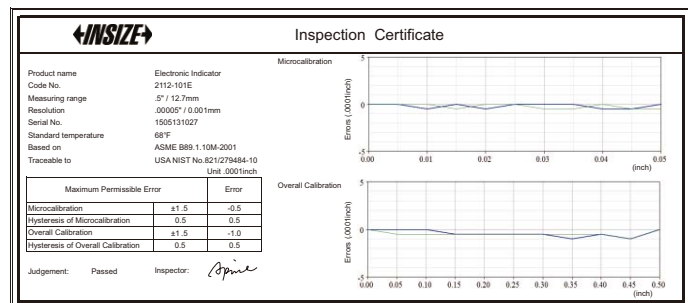



DATA OUTPUT

## ELECTRONIC INDICATORS (ADVANCED MODEL)

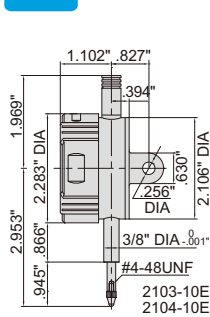
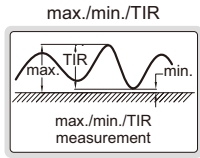

2103-10E

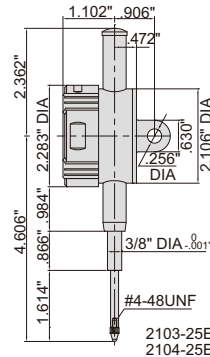

2104-25E

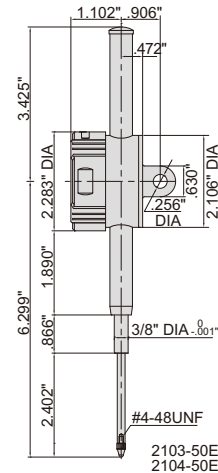

2103-50E

- Meet ASME B89.1.10M-2001
- Reading in digit and analog
- Display can be rotated by 320°
- Button function: tolerance Go and No-Go display, data preset, measuring direction change, max./min./TIR measurement, inch/metric conversion, absolute/incremental measurement
- Keep preset data and tolerance data in memory after restart
- CR2032 battery, automatic power off
- Data output
- Optional accessory: data output cable (part no. **7306-40**, **7302-SPC3A**, **7305-SPC1A**, **7305-C01**), backs (page 74), contact points (page 73)

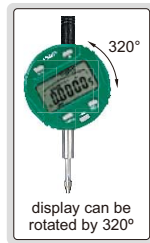

display can be rotated by 320°

spindle lift knob is included



analog pointer



warning when over tolerance

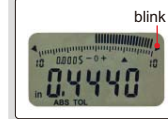

Resolution .00005"/0.001mm

Part No.	Range	Accuracy	Hysteresis	Remark
2103-10FE *	.5"/12.7mm	±.00015"	.00005"	flat back
2103-10E *	.5"/12.7mm	±.00015"	.00005"	lug back
2103-25E *	1"/25.4mm	±.00015"	.00005"	lug back
2103-50E *	2"/50.8mm	±.00015"	.00005"	lug back

Resolution .0005"/0.01mm

Part No.	Range	Accuracy	Hysteresis	Remark
2104-10E *	.5"/12.7mm	±.0015"	.0005"	lug back
2104-25E *	1"/25.4mm	±.0015"	.0005"	lug back
2104-50E *	2"/50.8mm	±.0015"	.0005"	lug back

\* Supplied with manufacturer inspection certificate traceable to NIST



ONE BATTERY FOR 4000 WORKING HOURS

DATA OUTPUT

## NO AUTO POWER OFF ELECTRONIC INDICATORS

spindle lift knob is included

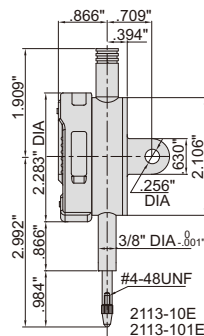

2113-10E

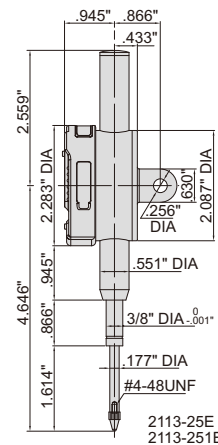

2113-251E

- Meet ASME B89.1.10M-2001
- No auto power off, tracking the deformation of mould and steel structure for a long time
- Low power consumption
- Button function: on/off, zero, inch/mm
- CR2032 battery
- Data output
- With lug back
- Optional accessory: backs (page 74), contact points (page 73), data output cable (part no. **7305-SPC1A**, **7305-C01**)

Resolution .00005"/0.001mm

Part No.	Range	Accuracy	Hysteresis
2113-101E *	.5"/12.7mm	±.00015"	.00005"
2113-251E *	1"/25.4mm	±.00015"	.00005"

Resolution .0005"/0.01mm

Part No.	Range	Accuracy	Hysteresis
2113-10E *	.5"/12.7mm	±.0015"	.0005"
2113-25E *	1"/25.4mm	±.0015"	.0005"

\* Supplied with manufacturer inspection certificate traceable to NIST



## WATERPROOF ELECTRONIC INDICATORS

WATERPROOF

DATA OUTPUT

**INSPECTION CERTIFICATE**  
TRACEABLE TO NIST

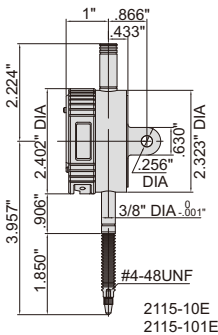

2115-10E

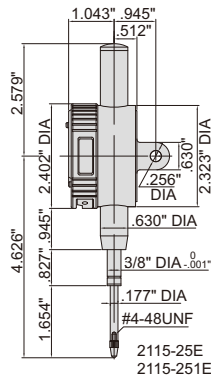

2115-25E

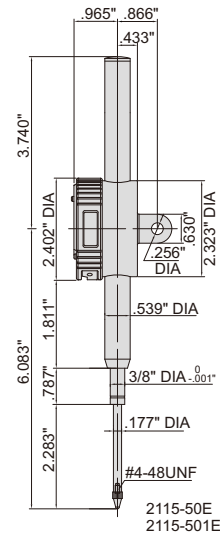

2115-50E

spindle lift knob is included (except 2115-10E/101E)



Resolution .00005"/0.001mm

Part No.	Range	Dust/waterproof	Accuracy	Hysteresis
2115-101E*	.5"/12.7mm	IP65	±.00015"	.00005"
2115-251E*	1"/25.4mm	IP54	±.00015"	.00005"
2115-501E*	2"/50.8mm	IP54	±.00015"	.00005"

Resolution .0005"/0.01mm

Part No.	Range	Dust/waterproof	Accuracy	Hysteresis
2115-10E*	.5"/12.7mm	IP65	±.0015"	.0005"
2115-25E*	1"/25.4mm	IP54	±.0015"	.0005"
2115-50E*	2"/50.8mm	IP54	±.0015"	.0005"

\* Supplied with manufacturer inspection certificate traceable to NIST

- Meet ASME B89.1.10M-2001
- Dust/waterproof
- Button function: on/off, zero, inch/mm
- CR2032 battery, automatic power off
- Data output
- With lug back
- Optional accessory: data output cable (part no. 7306-40, 7302-SPC3A, 7305-SPC1A, 7305-C01), backs (page 74), contact points (page 73)

## ELECTRONIC INDICATORS WITH LIFTING LEVER

**INSPECTION CERTIFICATE**  
TRACEABLE TO NIST

DATA OUTPUT

- Reading in digital and analog
- Display can be rotated by 320°
- Button function: tolerance Go and No-Go display, data preset, measuring direction change, max./min./TIR measurement, inch/metric conversion, absolute/incremental measurement
- Keep preset data and tolerance data in memory after restart
- CR2032 battery, automatic power off
- Data output
- With flat back
- Optional accessory: data output cable (part no. 7306-40, 7302-SPC3A, 7305-SPC1A, 7305-C01), backs (page 74), contact points (page 73)

warning when over tolerance

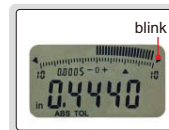

analog pointer



2109-10E

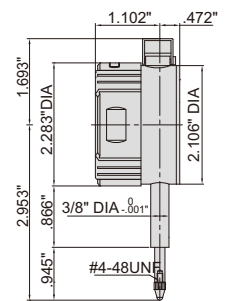

Part No.	Range	Resolution	Accuracy	Hysteresis
2109-10E*	.4"/10mm	.0005"/0.01mm	±.0015"	.0005"
2109-101E*	.4"/10mm	.00005"/0.001mm	±.00015"	.00005"

\* Supplied with manufacturer inspection certificate traceable to NIST



DATA OUTPUT

## BACK PLUNGER TYPE ELECTRONIC INDICATORS

analog pointer



warning when over tolerance



spindle lift knob is included



2118-10E

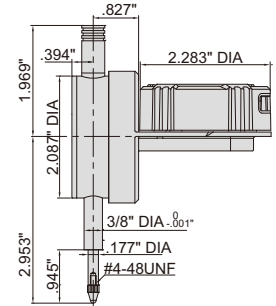

- Display can rotate 320°, display direction is changeable
- Reading in digit and analog
- Meet ASME B89.1.10-2001
- Button function: tolerance Go and No-Go display, data preset, measuring direction change, max./min./TIR measurement, inch/metric conversion, absolute/incremental measurement
- Keep preset data and tolerance data in memory after restart
- CR2032 battery, automatic power off
- Data output
- Optional accessory: data output cable (part no. 7306-40, 7302-SPC3A, 7305-SPC1A, 7305-C01), backs (page 74), contact points (page 73)

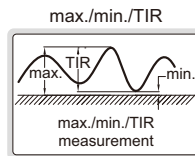

display can rotate 320°



Part No.	Range	Resolution	Accuracy	Hysteresis	Remark
2118-10E *	.5"/12.7mm	.0005"/0.01mm	±.0015"	.0005"	flat back
2118-101E*	.5"/12.7mm	.00005"/0.001mm	±.00015"	.00005"	flat back

\* Supplied with manufacturer inspection certificate traceable to NIST

display direction is changeable

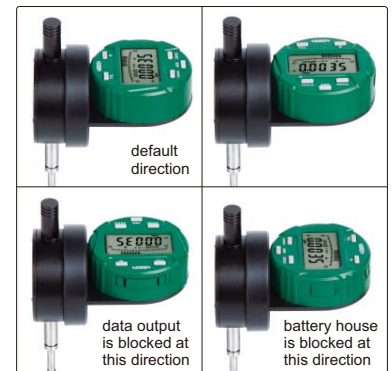

Remark: To change above direction, 4 fixing screws on the back of display need to be removed first.

## LARGE STROKE ELECTRONIC INDICATORS

DATA OUTPUT

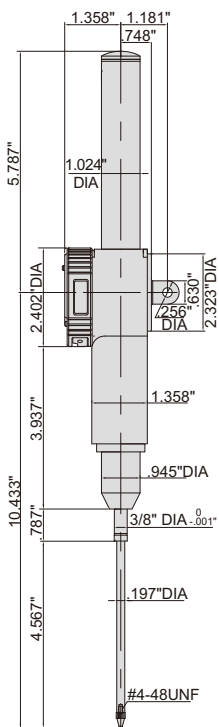

2117-100E

spindle lift knob is included



- Button function: on/off, zero, inch/mm
- CR2032 battery, automatic power off
- Data output
- With lug back
- Optional accessory: data output cable (part no. 7306-40, 7302-SPC3A, 7305-SPC1A, 7305-C01), backs (page 74), contact points (page 73)

Resolution .0005"/0.01mm

Part No.	Range	Accuracy	Hysteresis
2117-100E	4"/100mm	±.0015"	.0005"

Resolution .00005"/0.001mm

Part No.	Range	Accuracy	Hysteresis
2117-1001E	4"/100mm	±.00030"	.0001"

## DIAL COMPARATOR

**INSIZE PLUS**  
MADE IN GERMANY

- Jeweled bearing
- Shadow free dial face cover
- Supplied with limit pointers
- Initial measuring force 1.2N
- Optional accessory:  
lifting lever (part no. 6289-150)



2839-0004

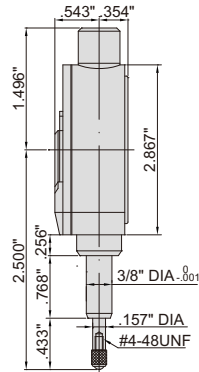

JEWELLED BEARING

**INSPECTION CERTIFICATE**  
TRACEABLE TO PTB

lever construction

within the measuring range, the spindle is in contact with the lever

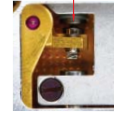

when the measuring range is exceeded, the spindle leaves the lever

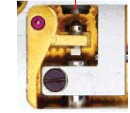

lifting lever (optional)

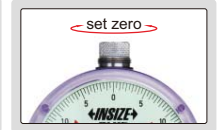

Part No.	Range	Graduation	Accuracy	Hysteresis	Dial reading	Remark
2839-0004 *	.004"	.00005"	.00005"	.00002"	20-0-20	flat back

\* Supplied with manufacturer inspection certificate traceable to PTB

7

## PRECISION DIAL INDICATOR

**INSIZE PLUS**  
MADE IN GERMANY



2836-004

- With lug back
- Jeweled bearing
- Supplied with limit pointers
- Optional accessory: contact points (page 73),  
lifting lever (part no. 6289-150)

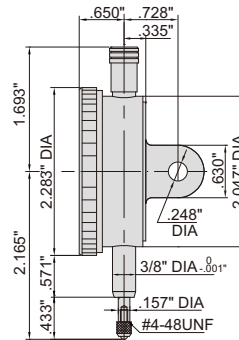

SHOCK PROOF

**INSPECTION CERTIFICATE**  
TRACEABLE TO PTB

lifting lever (optional)



lever construction

within the measuring range, the spindle is in contact with the lever



when the measuring range is exceeded, the spindle leaves the lever



Part No.	Range	Graduation	Accuracy	Hysteresis	Range/rev	Dial reading
2836-004 *	.04"	.00005"	±.0002"	.00005"	.005"	0-50

\* Supplied with manufacturer inspection certificate traceable to PTB

## COMPACT DIAL INDICATOR

**INSIZE PLUS**  
MADE IN GERMANY

- Meet ASME B89.1.10M-2001
- Shockproof
- With lug back
- Supplied with limit pointers
- Optional accessory: backs (page 74),  
contact points (page 73)



2832-02

SHOCK PROOF

**INSPECTION CERTIFICATE**  
TRACEABLE TO PTB

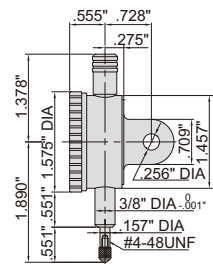

Part No.	Range	Graduation	Accuracy	Hysteresis	Range/rev	Dial reading
2832-02 *	.2"	.001"	±.001"	.00033"	.1"	0-100

\* Supplied with manufacturer inspection certificate traceable to PTB

**INSPECTION  
CERTIFICATE**  
TRACEABLE TO PTB

## DIAL INDICATORS

**INSIZE PLUS**  
MADE IN GERMANY



2837-1

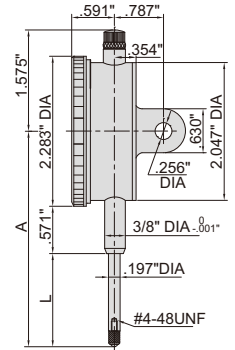

- Meet ASME B89.1.10M-2001
- Lug back
- Supplied with limit pointers
- Optional accessory: backs (page 74), contact points (page 73)

Part No.	Range	Graduation	Accuracy		Range/rev	Dial reading	L	A
			First 2.5 Rev	Overall				
2837-05 *	.5"	.001"	±.001'	±.002"	.1"	0-100	.827"	2.5"
2837-1 *	1"	.001"	±.001"	±.002"	.1"	0-100	1.319"	3.031"

\* Supplied with manufacturer inspection certificate traceable to PTB

**INSPECTION  
CERTIFICATE**  
TRACEABLE TO PTB

## BACK PLUNGER TYPE DIAL INDICATOR

**INSIZE PLUS**  
MADE IN GERMANY



2833-02

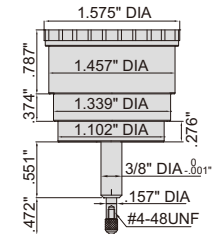

- Supplied with limit pointers
- Optional accessory: contact points (page 73)

Part No.	Range	Graduation	Accuracy		Hysteresis	Range/rev	Dial reading
			First 2.5 rev	Overall			
2833-02 *	.2"	.001"	±.001"	±.002'	.00033"	.01"	0-10-0

\* Supplied with manufacturer inspection certificate traceable to PTB

**INSPECTION  
CERTIFICATE**  
TRACEABLE TO NIST

SHOCK  
PROOF

JEWELLED  
BEARING

## PRECISION DIAL INDICATOR



2315-05

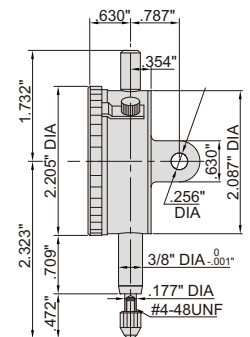

- Meet ASME B89.1.10M-2001
- Shockproof
- Jeweled bearing
- With lug back
- Supplied with limit pointers and bezel clamp
- Optional accessory: backs (page 74), contact points (page 73)

Part No.	Range	Graduation	Accuracy		Range/rev	Dial reading
			First 2.5 rev	Overall		
2315-05 *	.05"	.0001"	±.0001"	±.0003"	.01"	0-100

\* Supplied with manufacturer inspection certificate traceable to NIST



## COMPACT DIAL INDICATORS

- Meet ASME B89.1.10M-2001
- With lug back
- Supplied with limit pointers and bezel clamp
- Optional accessory: backs (page 74), contact points (page 73)



2304-01

**INSPECTION  
CERTIFICATE**  
TRACEABLE TO NIST

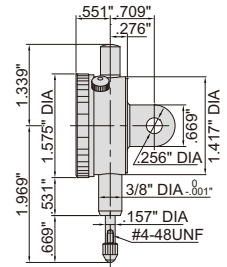

Part No.	Range	Graduation	Accuracy		Range/rev	Dial reading
			First 2.5 rev	Overall		
2304-01 *	.1"	.001"	—	±.001"	.1"	0-100
2304-02 *	.2"	.001"	—	±.001"	.1"	0-100
2304-025 *	.25"	.001"	±.001"	±.001"	.1"	0-100
2304-015 *	.1"	.0005"	—	±.0005"	.05"	0-50
2304-0205 *	.2"	.0005"	±.0005"	±.0015"	.05"	0-50
2304-0255 *	.25"	.0005"	±.0005"	±.0015"	.05"	0-50

\* Supplied with manufacturer inspection certificate traceable to NIST

## DIAL INDICATORS

- Meet ASME B89.1.10M-2001
- With lug back
- Supplied with limit pointers and bezel clamp
- Optional accessory: backs (page 74), contact points (page 73)



2307-1

**INSPECTION  
CERTIFICATE**  
TRACEABLE TO NIST

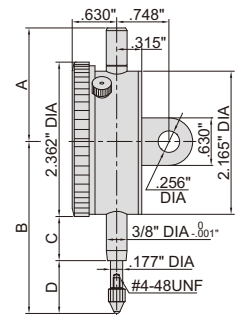

Part No.	Range	Graduation	Accuracy		Range/rev	Dial reading
			First 2.5 rev	Overall		
2307-025 *	.25"	.001"	±.001"	±.001"	.1"	0-100
2307-05 *	.5"	.001"	±.001"	±.002"	.1"	0-100
2307-1 *	1"	.001"	±.001"	±.002"	.1"	0-100
2307-2 *	2"	.001"	±.001"	±.004"	.1"	0-100
2307-0255 *	.25"	.0005"	±.0005"	±.0015"	.05"	0-50
2307-055 *	.5"	.0005"	±.0005"	±.0015"	.05"	0-50
2307-105 *	1"	.0005"	±.0005"	±.002"	.05"	0-50
2307-205 *	2"	.0005"	±.0005"	±.002"	.05"	0-50

Range	A	B	C	D
.25"	1.811"	2.953"	.787"	.984"
.5"	1.811"	2.953"	.787"	.984"
1"	1.811"	3.346"	.787"	1.378"
2"	4.370"	5.472"	1.969"	2.323"

\* Supplied with manufacturer inspection certificate traceable to NIST

## REVERSE READING DIAL INDICATOR

- Meet ASME B89.1.10M-2001
- With lug back
- Supplied with limit pointers and bezel clamp
- Optional accessory: backs (page 74), contact points (page 73)



2307-1R

**INSPECTION  
CERTIFICATE**  
TRACEABLE TO NIST

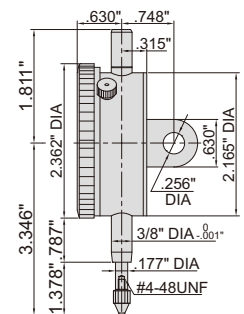

Part No.	Range	Graduation	Accuracy		Range/rev	Dial reading
			First 2.5 rev	Overall		
2307-1R *	1"	.001"	±.001"	±.002"	.1"	100-0

\* Supplied with manufacturer inspection certificate traceable to NIST

**INSPECTION  
CERTIFICATE**  
TRACEABLE TO NIST

**IP54  
WATERPROOF**

## WATERPROOF DIAL INDICATORS



2324-04A

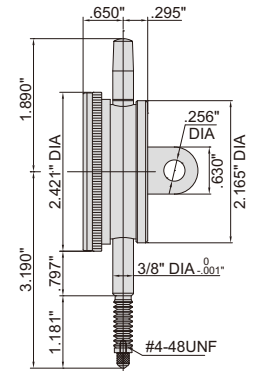

- Meet ASME B89.1.10M-2001
- IP54 dust/waterproof
- With limit pointers
- Optional accessory: backs (page 74), contact points (page 73)

Part No.	Range	Graduation	Accuracy		Range/rev	Dial reading	Remark
			First 2.5 rev	Overall			
2324-04FA *	.4"	.0005"	±.0005"	±.0015"	.05"	0-50	flat back
2324-04A *	.4"	.0005"	±.0005"	±.0015"	.05"	0-50	lug back

\* Supplied with manufacturer inspection certificate traceable to NIST

**INSPECTION  
CERTIFICATE**  
TRACEABLE TO NIST

## BACK PLUNGER TYPE DIAL INDICATOR

handle can be removed

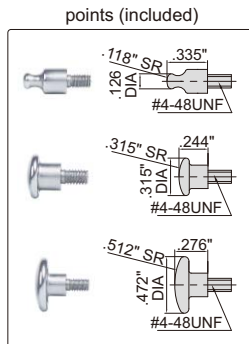

2320-02

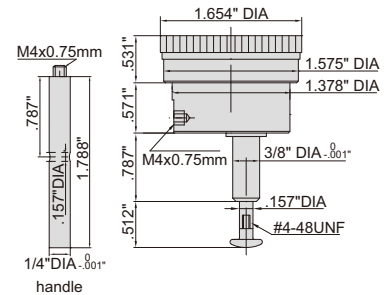

- Supplied with handle
- Optional accessory: contact points (page 73)

Part No.	Range	Graduation	Accuracy	Hysteresis	Range/rev	Dial reading
2320-02 *	.2"	.001"	±.001"	.00033"	.1"	0-100

\* Supplied with manufacturer inspection certificate traceable to NIST

**INSPECTION  
CERTIFICATE**  
TRACEABLE TO NIST

## LARGE DIAL FACE DIAL INDICATORS



2312-15

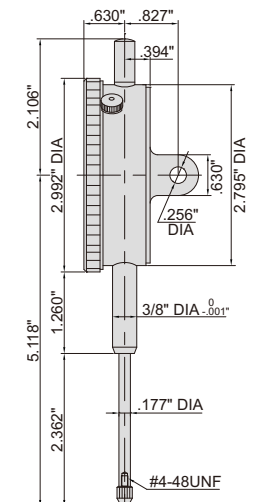

- Meet ASME B89.1.10M-2001
- With lug back
- Supplied with limit pointers and bezel clamp
- Optional accessory: contact points (page 73)

Part No.	Range	Graduation	Accuracy		Range/rev	Dial reading
			First 2.5 rev	Overall		
2312-15 *	1.5"	.001"	±.001"	±.004"	.1"	0-100
2312-2	2"	.001"	±.001"	±.004"	.1"	0-100

\* Supplied with manufacturer inspection certificate traceable to NIST

**LONG STROKE DIAL INDICATORS**



**2326-2**

7

- Graduation .001"
- With lug back
- Supplied with limit pointers and bezel clamp
- Optional accessory: backs (page 74), contact points (page 73)

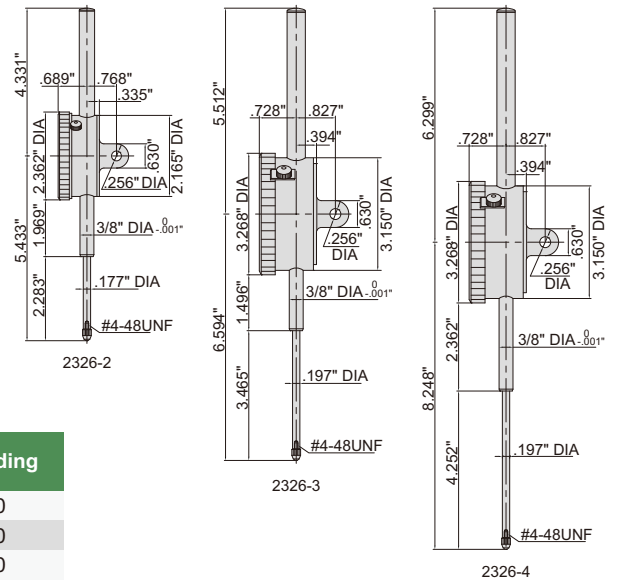

Part No.	Range	Accuracy		Range/rev	Dial reading
		First 2.5 rev	Overall		
2326-2 *	2"	±.001"	±.004"	.1"	0-100
2326-3 **	3"	±.001"	±.005"	.1"	0-100
2326-4 **	4"	±.001"	±.005"	.1"	0-100

\* Supplied with manufacturer inspection certificate traceable to NIST

\*\* 2326-3 and 2326-4 can only be used vertically

**SPINDLE LIFT KNOB**



**7332**

- For dial/electronic indicators with spindle diameter .177" DIA or .197" DIA

**Part No.**  
**7332**



**LIFTING LEVER**



**6289-150**

- The lifting cable permits quick lifting of the spindle of 2839 and 2836 series

**Part No.**  
**6289-150**

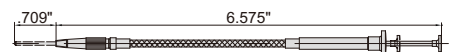

### BALL POINT

Part No.	Material of measuring face
6282-0102	carbide

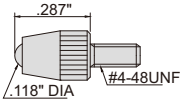

6282-0102

### SHELL TYPE POINT

Part No.	Material of measuring face
6282-0201	steel

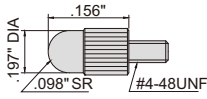

6282-0201

### SPHERICAL POINT

Part No.	Material of measuring face
6282-0402	steel

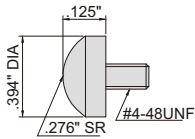

6282-0402

### CONICAL POINT

Part No.	Material of measuring face
6282-0702	steel

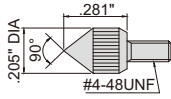

6282-0702

### FLAT POINT

Part No.	Material of measuring face
6282-1207	steel

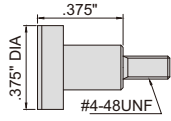

6282-1207

### ROLLER POINT

Part No.	Material of measuring face
6282-1902	steel

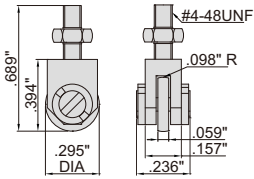

6282-1902

### EXTENSION RODS

Part No.	Material	L
6282-2018	steel	1"
6282-2019	steel	2"
6282-2020	steel	4"

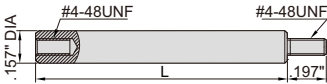

6282-2018



## MAGNETIC BACKS

Part No.	D (DIA)	For electronic/ dial indicators
7331-M1	2.028"	2103
		2104
		2109
		2112
		2113
		2115
		2117
7331-M2	2.126"	2307

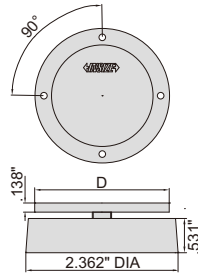

front



back



7331-M2

## LUG BACKS

7

Part No.	For electronic/ dial indicators
7330-L2	2324
	2315
7330-L3	2326-3
	2326-4
7330-L4	2304
7330-L5	2103
	2104
	2109
	2112
	2113
	2115
	2117
2118	
7330-L6	2307
	2326-2
7330-L7	2837
7330-L8	2832



7330-L2



7330-L8

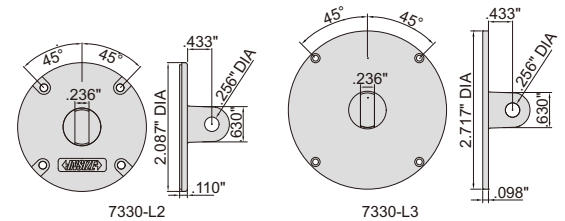

7330-L2

7330-L3

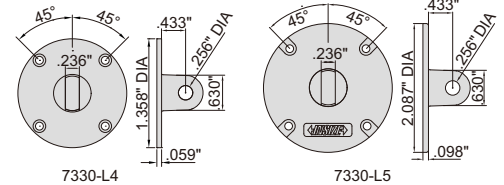

7330-L4

7330-L5

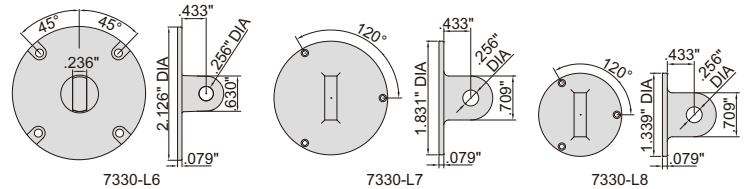

7330-L6

7330-L7

7330-L8

## FLAT BACKS

Part No.	For electronic/ dial indicators
7330-F2	2324
	2315
7330-F3	2326-3
	2326-4
7330-F4	2304
7330-F5	2103
	2104
	2109
	2112
	2113
	2115
	2117
2118	
7330-F6	2307
	2326-2
7330-F7	2837
7330-F8	2832



7330-F2



7330-F8

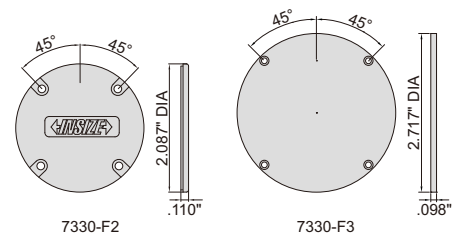

7330-F2

7330-F3

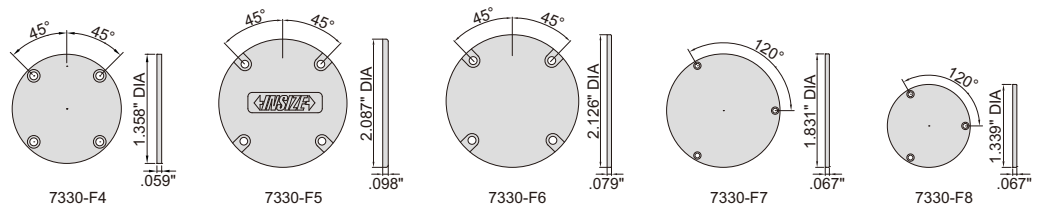

7330-F4

7330-F5

7330-F6

7330-F7

7330-F8

**INSPECTION  
CERTIFICATE**  
TRACEABLE TO PTB

## PRECISION DIAL TEST INDICATOR

**INSIZE PLUS**  
MADE IN GERMANY

- Ceramic bearing
- Anti magnetic carbide contact point
- Two measuring directions
- Supplied with one clamp: 3/8" DIA
- Optional accessory: styli (page 77)



2834-008

Part No.	Range	Graduation	Accuracy	Range/rev	Dial reading
2834-008 *	.008"	.0001"	±.0001"	.008"	0-4-0

\* Supplied with manufacturer inspection certificate traceable to PTB

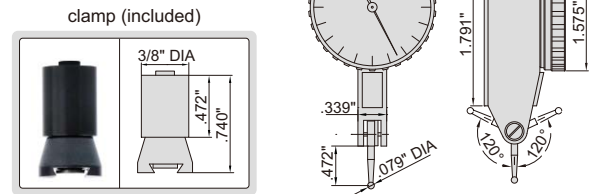

**INSPECTION  
CERTIFICATE**  
TRACEABLE TO PTB

## DIAL TEST INDICATOR

**INSIZE PLUS**  
MADE IN GERMANY

- Ceramic bearing
- Anti magnetic carbide contact point
- Two measuring directions
- Supplied with one clamp: 3/8" DIA
- Optional accessory: styli (page 77)



2835-03

Part No.	Range	Graduation	Accuracy	Range/rev	Dial reading
2835-03 *	.03"	.0005"	±.0005"	.015"	0-15-0

\* Supplied with manufacturer inspection certificate traceable to PTB

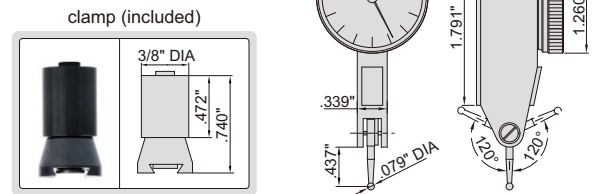

**INSPECTION  
CERTIFICATE**  
TRACEABLE TO NIST

**JEWELLED  
BEARING**

## DIAL TEST INDICATORS

- Jeweled bearing
- Carbide contact point
- Two measuring directions
- Anti magnetic body
- Supplied with two clamps: 5/32" DIA and 3/8" DIA
- Optional accessory: styli (page 77)



2380-31

Part No.	Range	Graduation	Accuracy	Dial reading	A	L
2380-31 *	.03"	.001"	±.001"	0-15-0	1.181" DIA	.50"
2380-35 *	.03"	.0005"	±.0005"	0-15-0	1.181" DIA	.50"
2380-301 *	.008"	.0001"	±.0001"	0-40-0	1.181" DIA	.563"
2381-31 *	.03"	.001"	±.001"	0-15-0	1.457" DIA	.50"
2381-35 *	.03"	.0005"	±.0005"	0-15-0	1.457" DIA	.50"
2381-301 *	.008"	.0001"	±.0001"	0-40-0	1.457" DIA	.563"

\* Supplied with manufacturer inspection certificate traceable to NIST

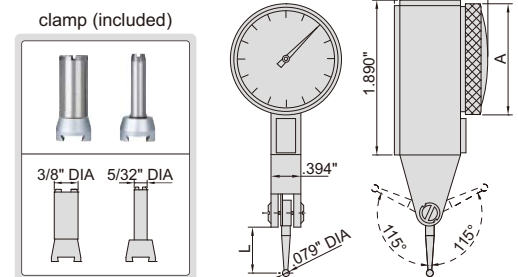

## BACK PLUNGER TYPE DIAL TEST INDICATOR

- Jeweled bearing
- Carbide contact point
- Two measuring directions
- Anti magnetic body
- Supplied with two clamps: 5/32" DIA and 3/8" DIA
- Optional accessory: styli (page 77)

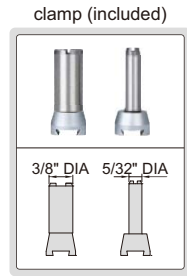

2398-03

JEWELLED BEARING

**INSPECTION CERTIFICATE**  
TRACEABLE TO NIST

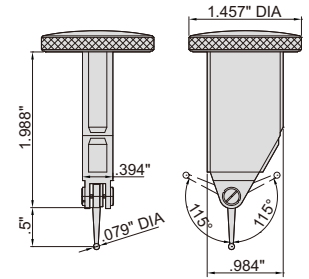

Part No.	Range	Graduation	Accuracy	Dial reading
2398-03*	.03"	.0005"	±.0005"	0-15-0

\* Supplied with manufacturer inspection certificate traceable to NIST

7

## TILTED FACE TYPE DIAL TEST INDICATOR

- Jeweled bearing
- Carbide contact point
- Two measuring directions
- Anti magnetic body
- Supplied with two clamps: 5/32" DIA and 3/8" DIA
- Optional accessory: styli (page 77)



2399-03

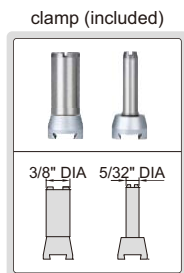

JEWELLED BEARING

**INSPECTION CERTIFICATE**  
TRACEABLE TO NIST

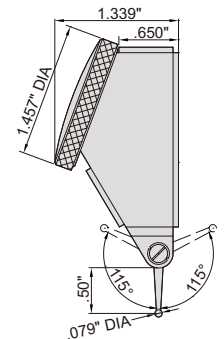

Part No.	Range	Graduation	Accuracy	Dial reading
2399-03*	.03"	.0005"	±.0005"	0-15-0

\* Supplied with manufacturer inspection certificate traceable to NIST

## LONG STYLI DIAL TEST INDICATOR

- Jeweled bearing
- Carbide contact point
- Two measuring directions
- Anti magnetic body
- Supplied with two clamps: 5/32" DIA and 3/8" DIA
- Optional accessory: styli (page 77)



2383-35A

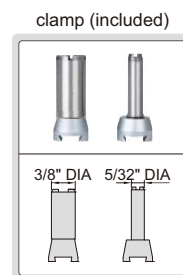

JEWELLED BEARING

**INSPECTION CERTIFICATE**  
TRACEABLE TO NIST

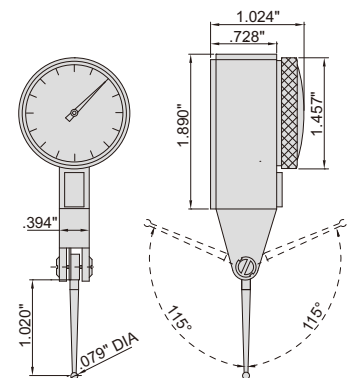

Part No.	Range	Graduation	Accuracy	Dial reading
2383-35A*	.03"	.0005"	±.0005"	0-15-0

\* Supplied with manufacturer inspection certificate traceable to NIST

**INSPECTION  
CERTIFICATE**  
TRACEABLE TO NIST

**JEWELLED  
BEARING**

## LARGE RANGE DIAL TEST INDICATOR

- Jeweled bearing
- Carbide contact point
- Two measuring directions
- Anti magnetic body
- Supplied with two clamps:  
5/32" DIA and 3/8" DIA
- Optional accessory: styli (page 77)



2386-006A

clamp (included)

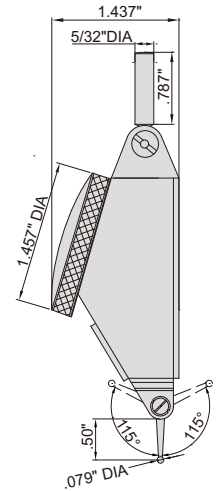
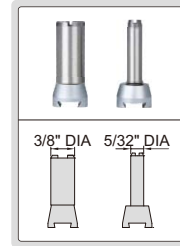

Part No.	Range	Graduation	Accuracy	Dial reading
2386-006A *	.06"	.0005"	±.0008"	0-15-0

\* Supplied with manufacturer inspection certificate traceable to NIST

7

**INSPECTION  
CERTIFICATE**  
TRACEABLE TO NIST

**JEWELLED  
BEARING**

## LARGE RANGE BACK PLUNGER TYPE DIAL TEST INDICATOR

- Jeweled bearing
- Carbide contact point
- Two measuring directions
- Anti magnetic body
- Supplied with two clamps:  
5/32" DIA and 3/8" DIA
- Optional accessory: styli (page 77)

clamp (included)

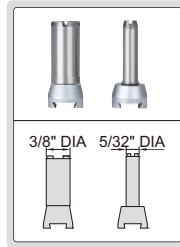

2480-06

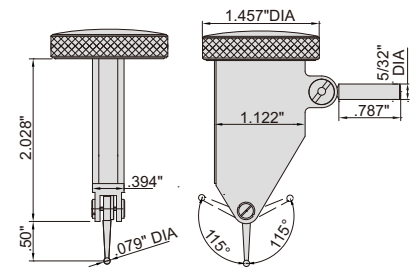

Part No.	Range	Graduation	Accuracy	Dial reading
2480-06 *	.06"	.0005"	±.0008"	0-15-0

\* Supplied with manufacturer inspection certificate traceable to NIST

## STYLI FOR DIAL TEST INDICATORS



6284-10

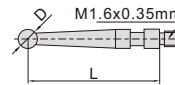

Part No.	For dial test indicator	Material of contact point	L	D
6284-91	2834-008	carbide	.472"	.039" DIA
6284-92		carbide	.472"	.079" DIA
6284-93		carbide	.472"	.118" DIA
6284-9	2380-31,2380-35, 2381-31, 2381-35,	steel	.50"	.039" DIA
6284-10		carbide	.50"	.079" DIA
6284-11		ruby	.50"	.079" DIA
6284-12	2398-03, 2399-03	carbide	.50"	.118" DIA
6284-13	2380-301, 2381-301	steel	.563"	.039" DIA
6284-14		carbide	.563"	.079" DIA
6284-15		ruby	.563"	.079" DIA
6284-16		carbide	.563"	.118" DIA

Part No.	For dial test indicator	Material of contact point	L	D
6284-94	2835-03	carbide	.437"	.039" DIA
6284-95		carbide	.437"	.079" DIA
6284-96		carbide	.437"	.118" DIA
6284-17	2383-35A	steel	1.020"	.039" DIA
6284-18		carbide	1.020"	.079" DIA
6284-19		ruby	1.020"	.079" DIA
6284-20		carbide	1.020"	.118" DIA
6284-65	2386-006A, 2480-06	steel	.50"	.039" DIA
6284-66		carbide	.50"	.079" DIA
6284-67		ruby	.50"	.079" DIA
6284-68		carbide	.50"	.118" DIA



## DIAL TEST INDICATOR HOLDERS



Part No.	Stem section (BxC)	Stem length (L)
6293-7	.354x.354"	2"
6293-3	.25x.5"	4"

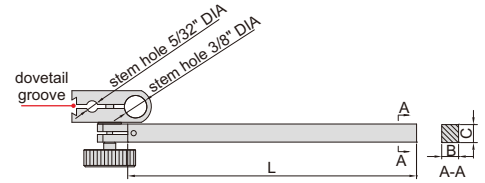

## DIAL TEST INDICATOR HOLDER

- Supplied with hex key

**Part No.**  
6296-2



6296-2

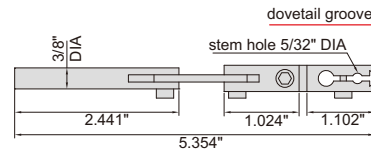

## DIAL TEST INDICATOR UNIVERSAL HOLDER

- Set the indicators at the desired attitude to the workpiece

**Part No.**  
6293-5



6293-5

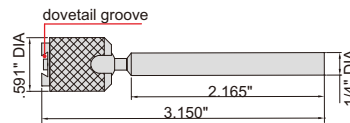

## DIAL TEST INDICATOR CENTERING HOLDER

- Center cylinders or holes on machine tools

**Part No.**  
6291-2



6291-2

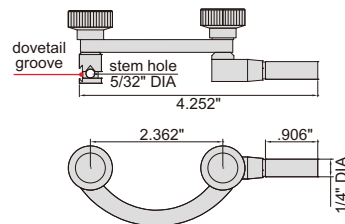

## UNIVERSAL MAGNETIC STAND (LIGHT DUTY)

**ATTENTION: LOW LOCKING FORCE**

- For electronic/dial indicators and dial test indicators

Part No.	Magnetic force	Applicable holding stem	Remark
6208-80E	176lbf	3/8" DIA	with fine adjustment and dovetail groove



6208-80E

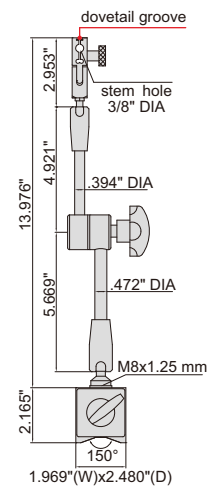

## UNIVERSAL MAGNETIC STANDS

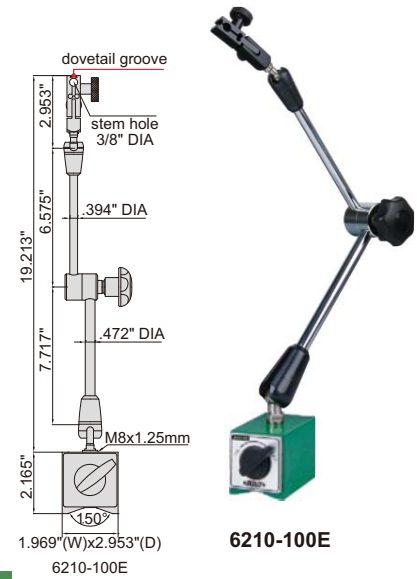
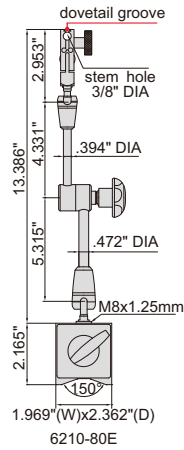
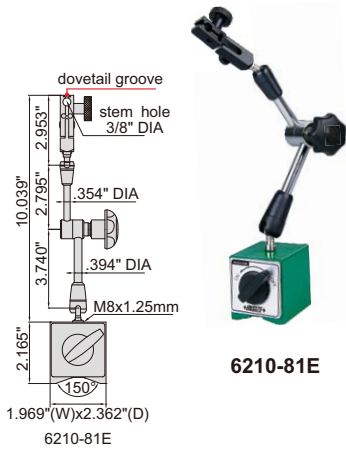

- For electronic/dial indicators and dial test indicators

Part No.	Magnetic force	Applicable holding stem	Remark
6210-81E	176lbf	3/8" DIA	with fine adjustment and dovetail groove
6210-80E	176lbf	3/8" DIA	with fine adjustment and dovetail groove
6210-100E	220lbf	3/8" DIA	with fine adjustment and dovetail groove

## MAGNETIC STANDS

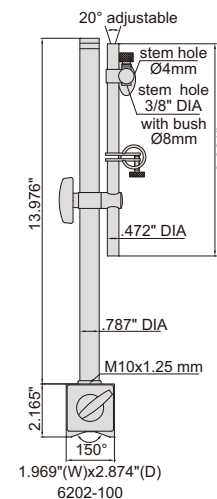
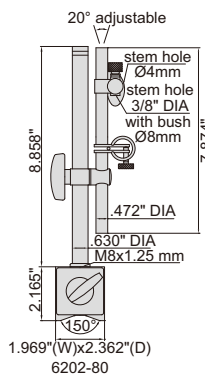
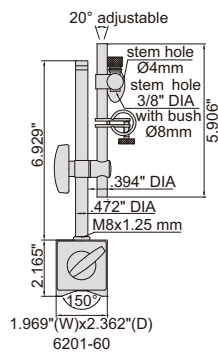
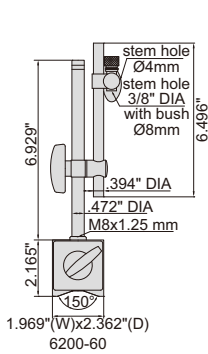

- For electronic/dial indicators and dial test indicators

Part No.	Magnetic force	Applicable holding stem	Remark
6200-60	132lbf	3/8" DIA, Ø8mm, Ø4mm	without fine adjustment
6201-60	132lbf	3/8" DIA, Ø8mm, Ø4mm	with fine adjustment
6202-80	176lbf	3/8" DIA, Ø8mm, Ø4mm	with fine adjustment
6202-100	220lbf	3/8" DIA, Ø8mm, Ø4mm	with fine adjustment

## MAGNETIC STAND WITH DOUBLE FINE ADJUSTMENT

- With double fine adjustments on the head and on the base
- For electronic/dial indicators and dial test indicators

Part No.	Magnetic force	Applicable holding stem	Remark
6272-80E	176lbf	3/8" DIA	with double fine adjustment and dovetail groove

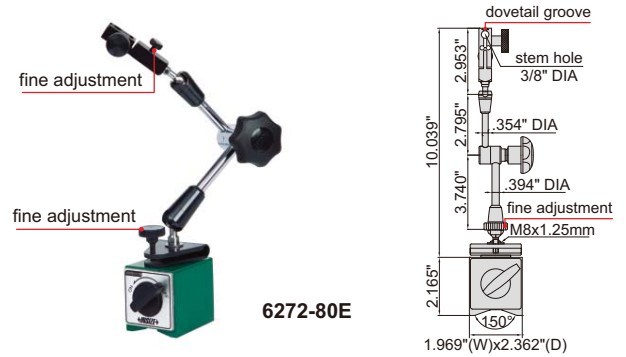

## MAGNETIC STAND FOR UNEVEN SURFACE

7

- For electronic/dial indicators and dial test indicators
- With fine adjustment

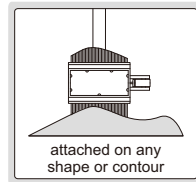

Part No.	Magnetic force	Applicable holding stem
6215-60	132lbf	3/8" DIA, Ø8mm, Ø4mm

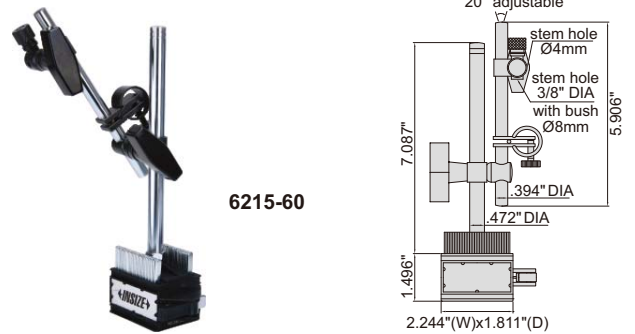

## VACUUM STAND

- Suitable for granite surface plates or cast iron surface plates
- For electronic/dial indicators and dial test indicators

Part No.	Diameter of vacuum disc	Vacuum force	Applicable holding stem	Remark
6217-BE	3.150" DIA	176lbf	3/8" DIA	with fine adjustment and dovetail groove

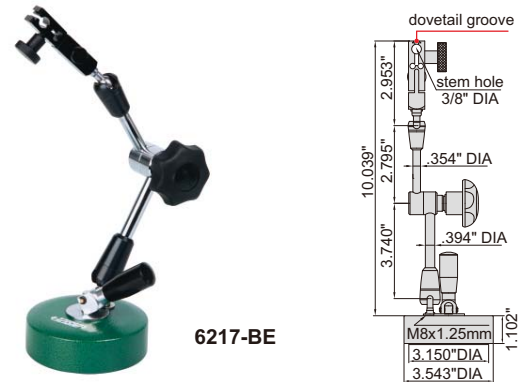

## FLEX ARM MAGNETIC STAND

ATTENTION: FOR DIAL TEST INDICATORS ONLY

- For dial test indicators

Part No.	Magnetic force	Applicable holding stem
6207-80A	176lbf	3/8" DIA, Ø8mm, Ø4mm

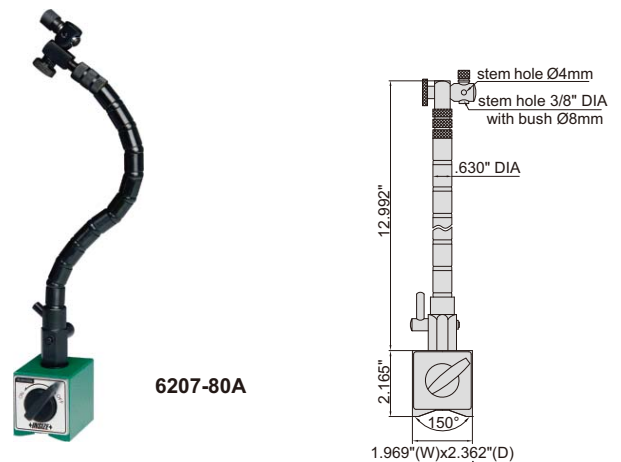

## UNIVERSAL STAND

- For electronic/dial indicators and dial test indicators
- With fine adjustment

Part No.	Applicable holding stem
6214-A	3/8" DIA, Ø8mm, Ø4mm

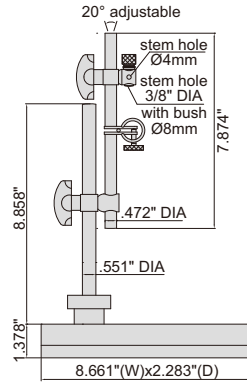

6214-A

ATTENTION: FOR DIAL TEST INDICATORS ONLY

- For dial test indicators
- With fine adjustment and dovetail groove

Part No.	Magnetic force	Applicable holding stem
6224-40E	88lbf	3/8" DIA

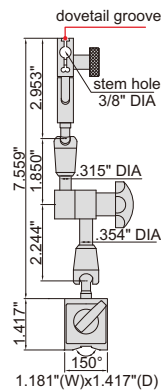

6224-40E

ATTENTION: FOR DIAL TEST INDICATORS ONLY

- For dial test indicators
- With dovetail groove

Part No.	Magnetic force	Applicable holding stem
6211-10E	22lbf	1/4" DIA, 3/8" DIA

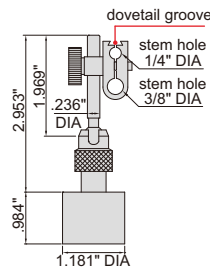

6211-10E

## GRANITE DIAL INDICATOR STAND

- Vertical travel of holder: 5.906"
- Fine adjustment range .079"
- Supplied with dust cover

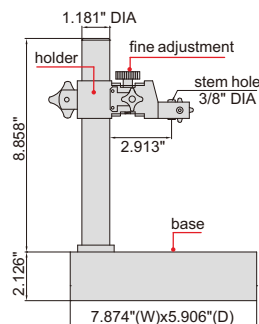

dust cover (included)



Part No.	Applicable holding stem	Base
6866-150E	3/8" DIA	flatness 98µin



6866-150E



## GRANITE DIAL INDICATOR STAND

dust cover (included)



- Vertical travel of holder: 9.843"
- Fine adjustment range: entire stroke
- Supplied with dust cover

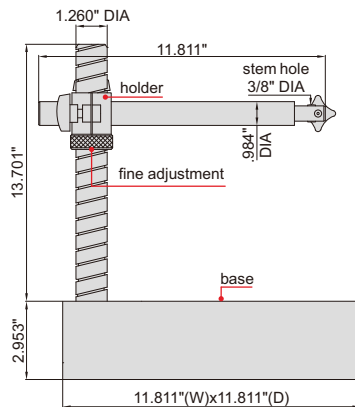

6867-250E

Part No.	Applicable holding stem	Base
6867-250E	3/8" DIA	flatness 110µm

## DIAL INDICATOR STAND

- Vertical travel of holder: 5.906"
- Fine adjustment range .079"
- Supplied with dust cover

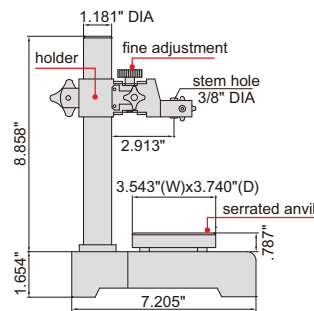

dust cover (included)



6863-150E

Part No.	Applicable holding stem	Anvil
6863-150E	3/8" DIA	serrated, flatness 59µm, hardness HRC60±2

## DIAL INDICATOR STAND

- Vertical travel of holder: 9.843"
- Fine adjustment range: entire stroke
- Supplied with dust cover

dust cover (included)



6864-250E

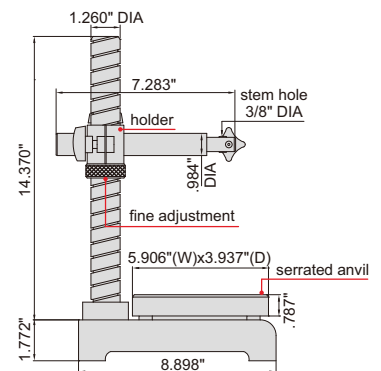

Part No.	Applicable holding stem	Anvil
6864-250E	3/8" DIA	serrated, flatness 59µm, hardness HRC60±2

dust cover (included)



- Vertical travel of holder: 3.937"
- Fine adjustment range .079"
- Supplied with dust cover

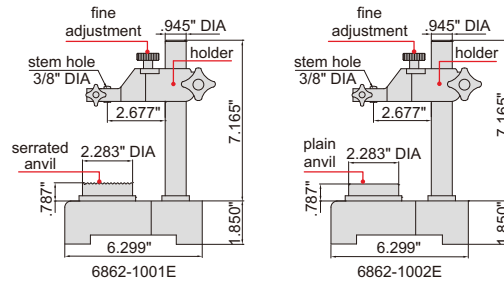

## DIAL INDICATOR STANDS



6862-1001E

6862-1002E

Part No.	Applicable holding stem	Anvil
6862-1001E	3/8" DIA	serrated, flatness 59µin, hardness HRC60±2
6862-1002E	3/8" DIA	plain, flatness 59µin, hardness HRC60±2

dust cover (included)



- Vertical travel of holder: 13.189"
- Fine adjustment range .079"
- Supplied with dust cover

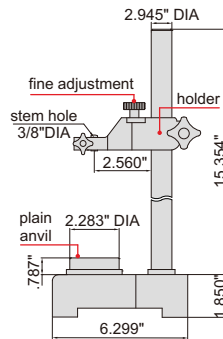

6865-300E

## TRANSFER STAND

7

Application



rigid construction, designed to make comparison height measurement (set zero with gage block then measure height of workpiece) with dial indicators or electronic indicators (variation of measuring force is high)

Part No.	Applicable holding stem	Anvil
6865-300E	3/8" DIA	plain, flatness 59µin, hardness HRC60±2



- Accuracy .00008"
- Optional accessory: dial test indicator, mini magnetic stand (part no. 6224-40E)

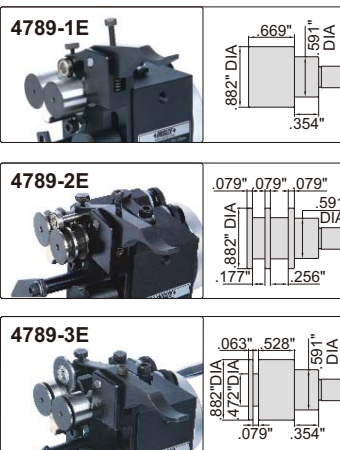

distance between measuring point and roller <1.181"

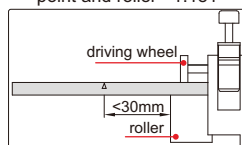

## CONCENTRICITY GAGES

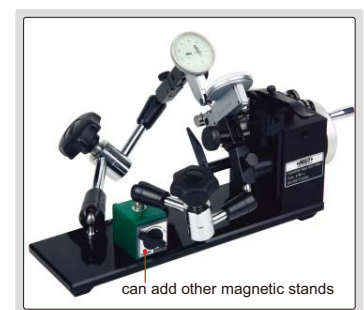
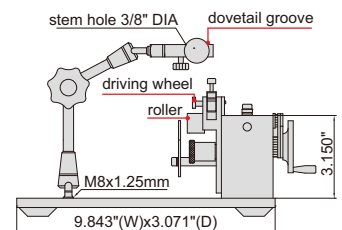

Part No.	Applicable diameter
4789-1E	.138" DIA~.984" DIA
4789-2E	.039" DIA~.984" DIA
4789-3E	.039" DIA~.984" DIA

## CONCENTRICITY GAGES

QUICK-POSITIONING, SUITABLE FOR MASS MEASUREMENT

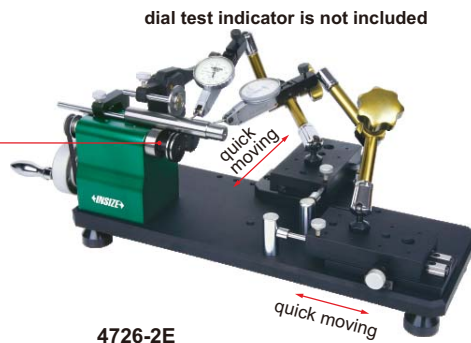
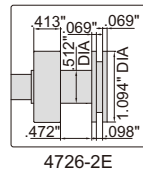
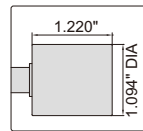

distance between measuring point and roller <math>< 1.181''</math>

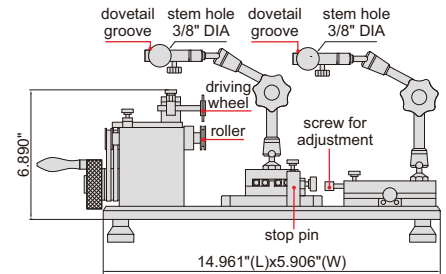
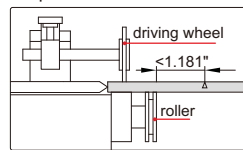

- With ball bearing, high stability, long working life
- Accuracy .00008"
- Optional accessory: dial test indicator

Part No.	Applicable diameter
4726-1E	.118" DIA-1.575" DIA
4726-2E	.039" DIA-1.575" DIA

7

## CONCENTRICITY GAGE



- Accuracy .0003"
- Optional accessory: dial test indicator

Part No.	Applicable inside diameter	Applicable outside diameter
4786-1E	.945" DIA~2.520" DIA	.079" DIA~2.756" DIA

for cylinder



for tube



distance between measuring point and chuck <math>< 1.969''</math>

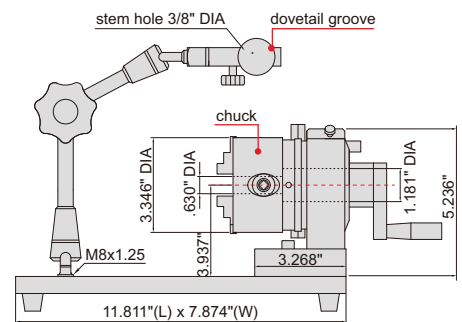
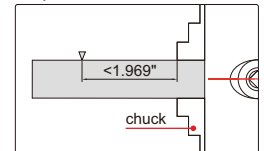

## MINI BENCH CENTER

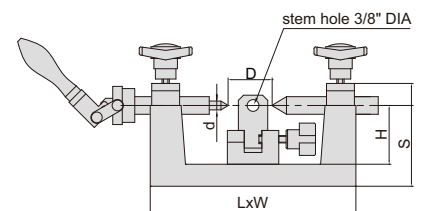

Part No.	Runout accuracy	Center height (H)	Distance between two centers (D)	Diameter of center (d)	Size (LxWxS)	Weight	Load
4721-75AE	.00008"	1.575"	1.378"~3.937"	.472" DIA	6.890x4.685x2.756"	9.93lb	8.8lb



## VERTICAL AND HORIZONTAL BENCH CENTER

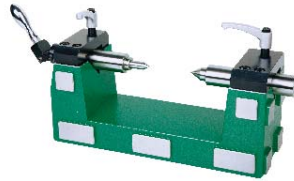
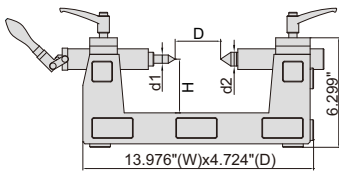

horizontal use



side use



vertical use

- For vertical, side and horizontal use

Part No.	Runout accuracy	Center height (H)	Distance between two centers (D)	Diameter of center (d1/d2)	Weight	Load
4722-200	.00008"	3.150"	7.874"	.472" DIA/.795"DIA	48.4lb	55lb

7

## BENCH CENTER (BASIC MODEL)

8

- Runout accuracy .00008"
- Distance between two centers: 11.811"
- Hardened cast-iron guide surface
- Movable column
- V-slot for cylinder .157" DIA-.866" DIA

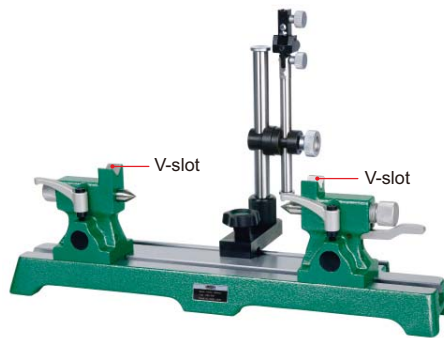

4782-300E

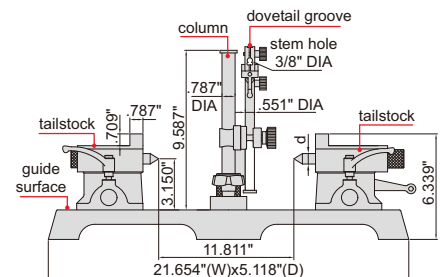

Part No.	Parallelism*	Center height	Diameter of center (d)	Load
4782-300E	.0004"	3.150"	.630" DIA	55lb

\* Parallelism of two centers to the guide surface

## INTERNAL DIAL CALIPER GAGES

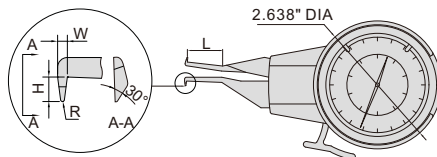

2222-E06

Part No.	Range	Graduation	Accuracy	L	H	W	R
2222-E06	.2-.6"	.0005"	±.0012"	.787"	.079"	.059"	.012"R
2222-E10	.2-1.0"	.0005"	±.0012"	1.378"	.059"	.039"	.012"R
2222-E121	.4-1.2"	.0005"	±.0012"	2.165"	.217"	.098"	.020"R
2222-E161	.8-1.6"	.0005"	±.0012"	3.150"	.236"	.118"	.020"R
2222-E201	1.2-2.0"	.0005"	±.0012"	3.150"	.315"	.118"	.020"R
2222-E24	1.6-2.4"	.0005"	±.0012"	3.150"	.315"	.118"	.020"R



## ELECTRONIC INTERNAL CALIPER GAGES

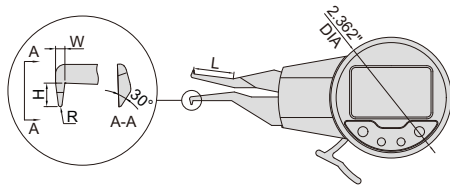

2121-15

- Resolution .0002"/0.005mm
- Reading in digit and analog
- Display can be rotated by 170°
- Button function: tolerance Go and No-Go display, data preset, max./min. measurement, data holding, inch/metric conversion, absolute/incremental measurement
- CR2032 battery, automatic power off
- Data output

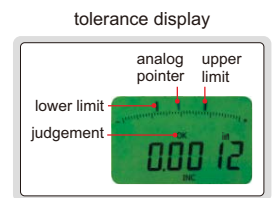
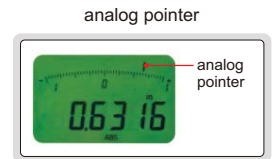
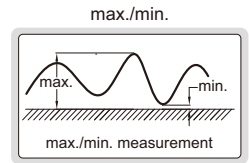

Part No.	Range	Accuracy	Repeatability	L	H	W	R
2121-15	.2-.6"/5-15mm	±.0012"	.0004"	.787"	.079"	.059"	.012"R
2121-25	.2-1.0"/5-25mm	±.0012"	.0004"	1.378"	.059"	.039"	.012"R
2121-31	.4-1.2"/10-30mm	±.0012"	.0004"	2.165"	.217"	.098"	.020"R
2121-41	.8-1.6"/20-40mm	±.0012"	.0004"	3.150"	.236"	.118"	.020"R
2121-51	1.2-2.0"/30-50mm	±.0012"	.0004"	3.150"	.315"	.118"	.020"R
2121-61	1.6-2.4"/40-60mm	±.0012"	.0004"	3.150"	.315"	.118"	.020"R

8

## ELECTRONIC INTERNAL CALIPER GAGES

DATA OUTPUT

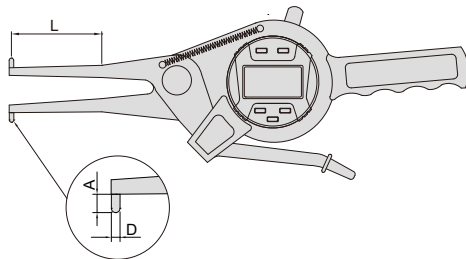

2151-35

- Carbide measuring tips
- Reading in digit and analog
- Display can be rotated by 320°
- Button function: tolerance Go and No-Go display, data preset, measuring direction change, max./min./TIR measurement, inch/metric conversion, absolute/incremental measurement
- CR2032 battery, automatic power off
- Data output
- Optional accessory: data output cable (part no. 7306-40, 7302-SPC3A, 7305-SPC1A, 7305-C01)

Part No.	Range	Resolution	Accuracy	L	A	D
2151-35	.6-1.4"/15-35mm	.0005"/0.01mm	±.0016"	1.969"	.118"	.118" DIA
2151-AL35	.6-1.4"/15-35mm	.0005"/0.01mm	±.0016"	7.874"	.118"	.118" DIA
2151-55	1.4-2.2"/35-55mm	.0005"/0.01mm	±.0016"	3.150"	.236"	.118" DIA
2151-AL55	1.4-2.2"/35-55mm	.0005"/0.01mm	±.0016"	9.843"	.315"	.118" DIA
2151-75	2.2-3"/55-75mm	.0005"/0.01mm	±.0016"	3.543"	.315"	.118" DIA
2151-AL75	2.2-3"/55-75mm	.0005"/0.01mm	±.0016"	9.843"	.315"	.118" DIA
2151-95	3-3.8"/75-95mm	.0005"/0.01mm	±.0016"	3.937"	.315"	.118" DIA
2151-115	3.8-4.6"/95-115mm	.0005"/0.01mm	±.0016"	4.724"	.394"	.126" DIA
2151-135	4.6-5.4"/115-135mm	.0005"/0.01mm	±.0016"	4.724"	.394"	.126" DIA

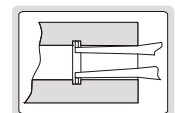

## EXTERNAL DIAL CALIPER GAGES

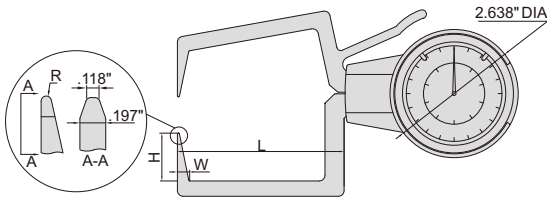

Part No.	Range	Graduation	Accuracy	L	H	W	R
2333-E081	0-.8"	.0005"	±.0012"	3.150"	.984"	.256"	.020"R
2333-E121	.4-1.2"	.0005"	±.0012"	3.150"	.984"	.256"	.020"R
2333-E161	.8-1.6"	.0005"	±.0012"	3.150"	.984"	.256"	.020"R
2333-E201	1.2-2.0"	.0005"	±.0012"	3.150"	.984"	.256"	.020"R
2333-E24	1.6-2.4"	.0005"	±.0012"	3.150"	.984"	.256"	.020"R



2333-E161

## ELECTRONIC EXTERNAL CALIPER GAGES

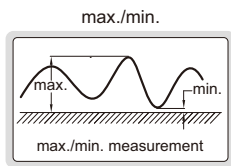

- Resolution .0002"/0.005mm
- Reading in digit and analog
- Display can be rotated by 170°
- Button function: tolerance Go and No-Go display, data preset, max./min. measurement, data holding, inch/metric conversion, absolute/incremental measurement
- CR2032 battery, automatic power off
- Data output



2131-21

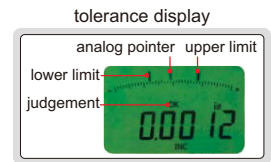
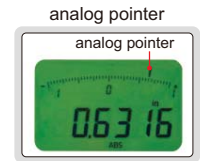

Part No.	Range	Accuracy	Repeatability	L	H	W	R
2131-21	0-.8"/0-20mm	±.0012"	.0004"	3.150"	.984"	.256"	.020"R
2131-31	.4-1.2"/10-30mm	±.0012"	.0004"	3.150"	.984"	.256"	.020"R
2131-41	.8-1.6"/20-40mm	±.0012"	.0004"	3.150"	.984"	.256"	.020"R
2131-51	1.2-2.0"/30-50mm	±.0012"	.0004"	3.150"	.984"	.256"	.020"R
2131-61	1.6-2.4"/40-60mm	±.0012"	.0004"	3.150"	.984"	.256"	.020"R

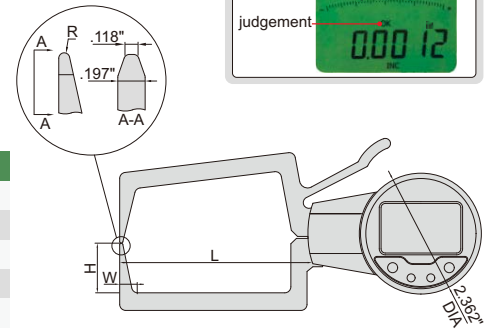

### DATA OUTPUT

- Carbide measuring tips
- Reading in digit and analog
- Display can be rotated by 320°
- Button function: tolerance Go and No-Go display, data preset, measuring direction change, max./min./TIR measurement, inch/metric conversion, absolute/incremental measurement
- CR2032 battery, automatic power off
- Data output
- Optional accessory: data output cable (part no. 7306-40, 7302-SPC3A, 7305-SPC1A, 7305-C01)

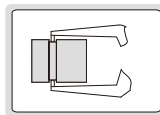

## ELECTRONIC EXTERNAL CALIPER GAGES



2132-20

Part No.	Range	Resolution	Accuracy	L
2132-20	0-.8"/0-20mm	.0005"/0.01mm	±.0016"	2.362"
2132-40	.8-1.6"/20-40mm	.0005"/0.01mm	±.0016"	2.362"
2132-60	1.6-2.4"/40-60mm	.0005"/0.01mm	±.0016"	2.165"
2132-80	2.4-3.2"/60-80mm	.0005"/0.01mm	±.0016"	2.165"
2132-100	3.2-4"/80-100mm	.0005"/0.01mm	±.0016"	2.165"

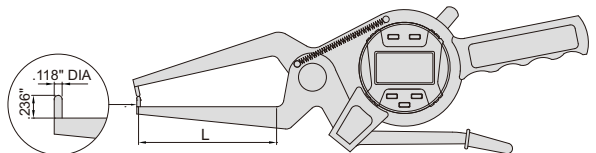

## ELECTRONIC THICKNESS GAGES

- Ceramic spindle tip and anvil
- Buttons: on/off, zero, inch/mm
- Battery CR2032, automatic power off
- Data output
- Optional accessory: data output cable (part no. 7306-40, 7302-SPC3A, 7305-SPC1A, 7305-C01)

Part No.	Range	Resolution	Accuracy
2871-10	0-.4"/0-10mm	.0005"/0.01mm	±.0008"
2871-101	0-.4"/0-10mm	.00005"/0.001mm	±.0002"

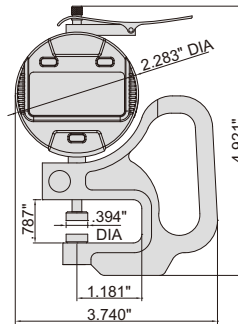

DATA  
OUTPUT

2871-101

## THICKNESS GAGES

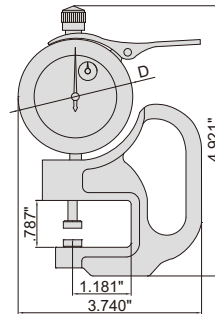
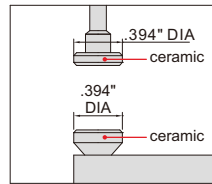

Part No.	Range	Graduation	Accuracy	D
2364-055	0-.5"	.0005"	±.0008"	2.283" DIA
2364-005	0-.05"	.0001"	±.0003"	2.205" DIA

2364-055

## ELECTRONIC THICKNESS GAGE

- Ceramic spindle tip and anvil
- Buttons: on/off, zero, inch/mm
- Battery Cr2032
- Automatic power off
- Data output
- Optional accessory: data output cable (part no. 7306-40, 7302-SPC3A, 7305-SPC1A, 7305-C01)

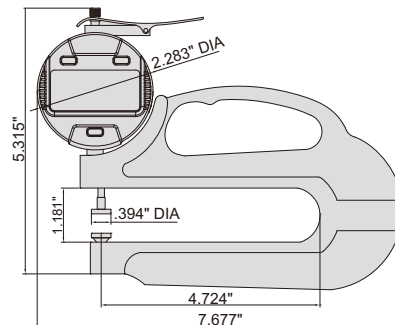

DATA  
OUTPUT

2872-10

Part No.	Range	Resolution	Accuracy
2872-10	0-.4"/0-10mm	.0005"/0.01mm	±.0008"

## THICKNESS GAGE

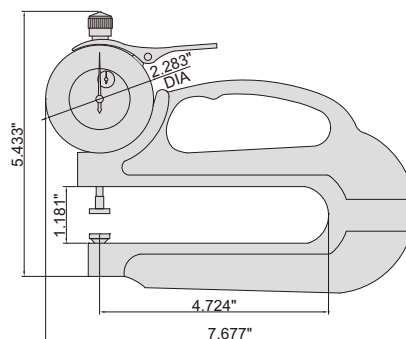
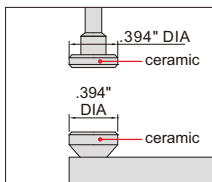

Part No.	Range	Graduation	Accuracy
2365-055	0-.5"	.0005"	±.0008"

2365-055



DATA OUTPUT



measure wall thickness of groove

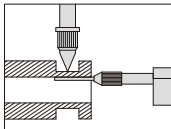

- Buttons: on/off, zero, inch/mm
- Battery CR2032, automatic power off
- Data output
- Optional accessory: data output cable (part no. 7306-40, 7302-SPC3A, 7305-SPC1A, 7305-C01)

Part No.	Range	Resolution	Accuracy
2873-10	0-.4"/0-10mm	.0005"/0.01mm	±.0008"

## ELECTRONIC TUBE THICKNESS GAGE



2873-10

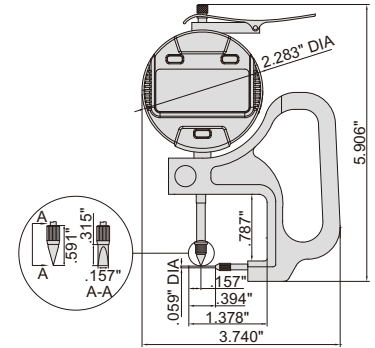

DATA OUTPUT

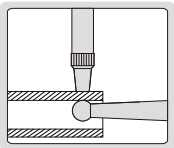

- Buttons: on/off, zero, inch/mm
- Battery CR2032, automatic power off
- Data output
- Optional accessory: data output cable (part no. 7306-40, 7302-SPC3A, 7305-SPC1A, 7305-C01)

Part No.	Range	Resolution	Accuracy
2876-10	0-.4"/0-10mm	.0005"/0.01mm	±.0008"

## ELECTRONIC TUBE THICKNESS GAGE



2876-10

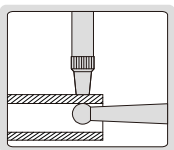
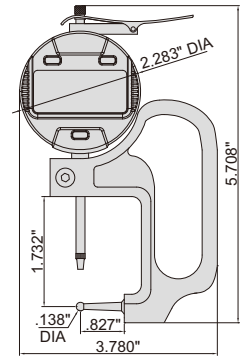

- Measure tube wall thickness

Part No.	Range	Graduation	Accuracy
2367-055	0-.5"	.0005"	±.0008"

## TUBE THICKNESS GAGE



2367-055

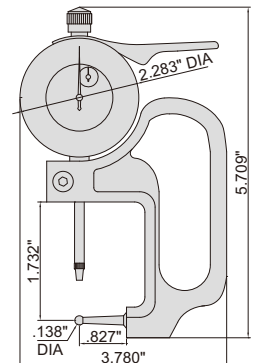

- Stainless steel spindle tip and anvil

Part No.	Range	Graduation	Accuracy
2363-055	0-.5"	.0005"	±.0015"



2363-055

## THICKNESS GAGE

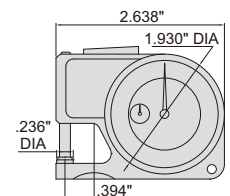



## DIAL SNAP GAGES

- For quick Go/No-Go judgment of diameter of cylinders and shafts
- Left anvil retracting stroke .079"
- Measuring force: 1.35-1.8lbf
- Flatness of anvil: 59µin
- Repeatability: 39µin
- Carbide measuring faces for anvils
- Front edges of anvils are chamfered for easy workpiece insertion
- Optional accessory: dial indicators and electronic indicators (reading .00005" or .0005")



2186-25E

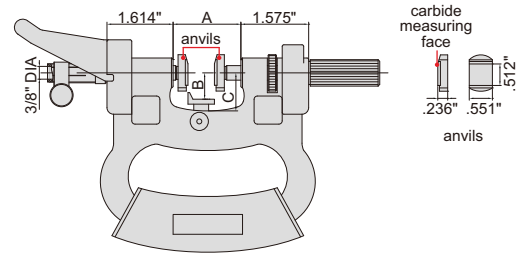

Part No.	Range	Parallelism of measuring faces	A	B	C
2186-25E	0-1"	157µin	1.654"	.433-.709"	.787"
2186-50E	1-2"	157µin	2.717"	.433-1.260"	1.614"
2186-75E	2-3"	197µin	3.701"	.669-1.614"	2.008"
2186-100E	3-4"	236µin	4.685"	1.220-2.165"	2.559"
2186-125E	4-5"	236µin	5.669"	1.654-2.756"	2.953"
2186-150E	5-6"	315µin	6.654"	2.165-3.228"	3.543"
2186-175E	6-7"	315µin	7.638"	2.677-3.740"	3.937"
2186-200E	7-8"	394µin	8.622"	3.346-4.331"	4.528"
2186-225E	8-9"	394µin	9.606"	3.740-4.724"	5.118"
2186-250E	9-10"	394µin	10.591"	4.331-5.315"	5.709"
2186-275E	10-11"	472µin	11.575"	4.724-5.906"	6.299"
2186-300E	11-12"	472µin	12.559"	5.039-6.299"	6.693"

8

## ADJUSTABLE SNAP GAGES



2187-6

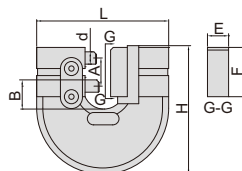

0-.24"



2187-19

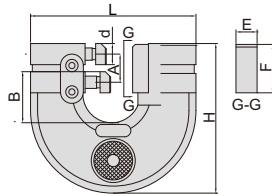

over .24"

- Used as Go/No-Go gage by setting upper and lower limits
- Flatness of anvil: 59µin
- Parallelism of measuring faces:
  - range 0-1.26": 118µin
  - range 1.26-3.50": 157µin
  - range 3.50-11.81": 197µin

Part No.	Range	L	A	B	E	F	H	d (DIA)
2187-6	0-.24"	2.913"	.591"	.689"	.480"	1.071"	2.815"	.276"
2187-13	.24-.51"	3.346"	.591"	1.024"	.480"	1.071"	3.130"	.484"
2187-19	.51-.75"	3.661"	.591"	1.063"	.480"	1.071"	3.268"	.484"
2187-25	.75-.98"	3.937"	.591"	1.319"	.480"	1.071"	3.524"	.484"
2187-32	.98-1.26"	4.370"	.709"	1.516"	.598"	1.386"	4.094"	.602"
2187-38	1.26-1.50"	4.606"	.709"	1.634"	.598"	1.386"	4.134"	.602"
2187-44	1.50-1.73"	4.843"	.709"	1.752"	.598"	1.386"	4.291"	.602"
2187-51	1.73-2.01"	5.118"	.709"	1.890"	.598"	1.386"	4.606"	.602"
2187-57	2.01-2.24"	5.354"	.709"	1.772"	.598"	1.386"	4.685"	.602"
2187-63	2.24-2.48"	5.630"	.709"	1.969"	.598"	1.386"	4.803"	.602"
2187-70	2.48-2.76"	6.142"	.787"	2.283"	.598"	1.386"	5.197"	.602"
2187-76	2.76-2.99"	6.417"	.787"	2.382"	.598"	1.386"	5.394"	.602"
2187-82	2.99-3.23"	6.654"	.787"	2.539"	.598"	1.386"	5.512"	.602"
2187-89	3.23-3.50"	6.890"	.787"	2.618"	.598"	1.386"	5.748"	.602"
2187-95	3.50-3.74"	7.126"	.787"	2.736"	.598"	1.386"	5.866"	.602"
2187-101	3.74-3.98"	7.402"	.787"	2.756"	.598"	1.386"	6.063"	.602"
2187-108	3.98-4.25"	7.795"	.945"	3.110"	.598"	1.543"	6.535"	.602"
2187-114	4.25-4.49"	8.031"	.945"	3.189"	.598"	1.543"	6.772"	.602"
2187-120	4.49-4.72"	8.268"	.945"	3.386"	.598"	1.543"	7.047"	.602"
2187-127	4.72-5.00"	8.543"	.945"	3.524"	.598"	1.543"	7.323"	.602"
2187-133	5.00-5.24"	8.780"	.945"	3.642"	.598"	1.543"	7.559"	.602"
2187-139	5.24-5.47"	9.016"	.945"	3.760"	.598"	1.543"	7.756"	.602"
2187-146	5.47-5.75"	9.252"	.945"	3.878"	.598"	1.543"	7.913"	.602"
2187-152	5.75-5.98"	9.528"	.945"	4.016"	.598"	1.543"	8.071"	.602"
2187-163	5.98-6.42"	10.748"	.843"	4.201"	.717"	1.543"	8.307"	.720"
2187-175	6.42-6.89"	10.748"	.843"	4.201"	.717"	1.543"	8.307"	.720"
2187-188	6.89-7.40"	11.752"	.843"	4.713"	.717"	1.543"	8.937"	.720"
2187-200	7.40-7.87"	11.752"	.843"	4.713"	.717"	1.543"	8.937"	.720"
2187-213	7.87-8.39"	12.756"	.843"	5.185"	.717"	1.543"	9.528"	.720"
2187-225	8.39-8.86"	12.756"	.843"	5.185"	.717"	1.543"	9.528"	.720"
2187-238	8.86-9.37"	13.760"	.843"	5.697"	.717"	1.543"	9.843"	.720"
2187-250	9.37-9.84"	13.760"	.843"	5.866"	.717"	1.543"	9.843"	.720"
2187-263	9.84-10.35"	14.783"	.843"	6.209"	.717"	1.543"	10.945"	.720"
2187-275	10.35-10.83"	14.783"	.843"	6.209"	.717"	1.543"	10.945"	.720"
2187-288	10.83-11.34"	15.748"	.843"	6.720"	.717"	1.543"	11.457"	.720"
2187-300	11.34-11.81"	15.748"	.843"	6.720"	.717"	1.543"	11.457"	.720"



**IP54**  
WATERPROOF

**ATTENTION:**  
BASIC MODEL

- Go/No-Go judgement for mass production
- Dial indicator: range  $\pm 0.0015"$ , graduation  $.00005"$ , accuracy  $.00004"$
- IP54 dust/waterproof
- Measuring force: 1.125-2.25lbf
- Carbide measuring faces
- Supplied with setting standards (except 0-1")

Part No.	Range	L	D
3334-1	0-1"	1.122"	.984"
3334-2	1-2"	2.106"	1.378"
3334-3	2-3"	3.091"	1.870"
3334-4	3-4"	4.075"	2.362"



3334-1

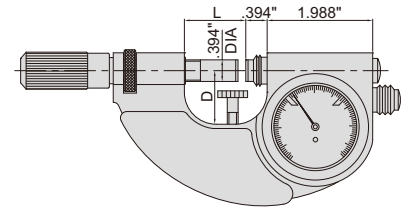

## DIAL SNAP GAGES

**DATA**  
OUTPUT

- Optional accessory: data output cable (part no. 7306-20, 7302-SPC1A/SPC1B, 7305-SPC2)

Part No.	Range	Resolution	Accuracy
2166-12	0-.5"/0-12mm	.0005"/0.01mm	$\pm 0.0012"$



2166-12

## ELECTRONIC SNAP GAGE

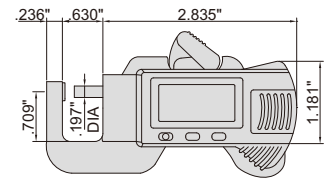

## ELECTRONIC SNAP GAGE

**ATTENTION: NO**  
DATA OUTPUT



2167-25

Part No.	Range	Resolution	Accuracy
2167-25	0-1"/0-25mm	.0005"/0.01mm	$\pm 0.0012"$

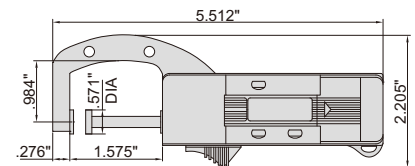

## ELECTRONIC SNAP GAGE

**DATA**  
OUTPUT

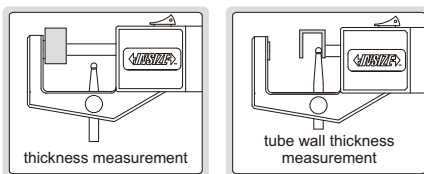

2163-25

- Resolution  $.0005"/0.01mm$
- Accuracy:  $\pm 0.0016"$
- For thickness and tube wall thickness measurement
- Optional accessory: data output cable (part no. 7306-20, 7302-SPC1A/SPC1B, 7305-SPC2)

Part No.	Thickness range	Tube wall thickness range
2163-25	0-1"/0-25mm	.08"/0-2mm

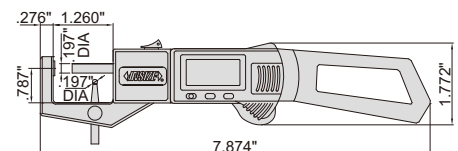

## ELECTRONIC SNAP GAGE

DATA  
OUTPUT

- Buttons: on/off, zero, inch/mm
- Automatic power off, move the digital unit to turn on power
- Battery CR2032
- Data output
- Made of stainless steel
- Optional accessory: data output cable (part no. 7306-20, 7302-SPC5A/SPC5B, 7305-SPC2A, 7305-A01/A02)



1163-50A

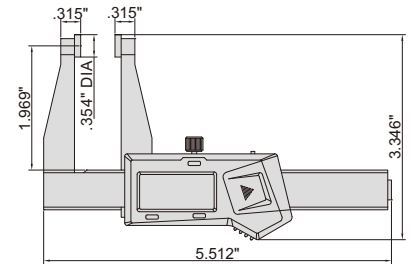

Part No.	Range	Resolution	Accuracy
1163-50A	0-2"/0-50mm	.0005"/0.01mm	±.0012"

## 8 ELECTRONIC 3-PURPOSE SNAP GAGE

SUITABLE FOR  
JEWELLERY

- Buttons: zero, inch/mm, on/off
- Battery LR44
- Made of stainless steel

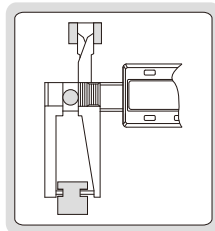

2164-25A

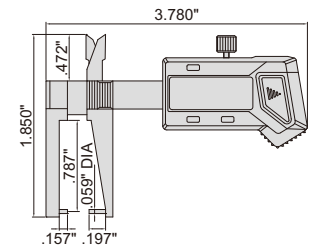

Part No.	Range	Resolution	Accuracy
2164-25A	0-1"/0-25mm	.0005"/0.01mm	±.0012"

## STEP AND GAP GAGE

DATA  
OUTPUT

zero setting block  
(included)



front



back

2168-12

- Measure step height and gap width
- Resolution .0005"/0.01mm
- Buttons: on/off, zero, inch/mm
- Automatic power off, move the digital unit to turn on power
- Battery CR2032
- Data output
- Made of stainless steel
- Supplied with zero setting block
- Optional accessory: data output cable (part no. 7306-20, 7302-SPC5A/SPC5B, 7305-SPC2A, 7305-A01/A02)

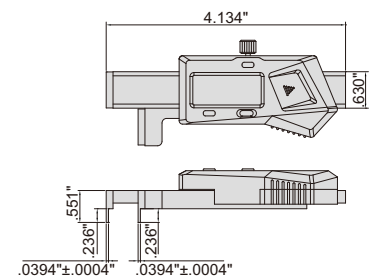
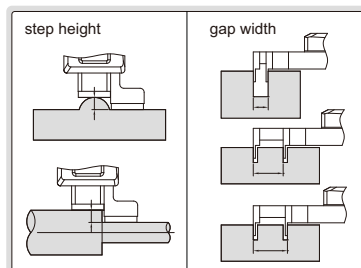

Part No.	Range	Accuracy
2168-12	0-.5"/0-12.7mm	±.0012"



<b>←INSIZE→</b>							
INSPECTION CERTIFICATE							
GAGE BLOCKS				CODE: 4102-36 GRADE: AS-0			
Nominal Size (in)	Identification No.	Deviation (µin)	Nominal Size (in)	Identification No.	Deviation (µin)	Nominal Size (in)	Deviation (µin)
.050	12893	+2	.102	12281	0	.150	13234
.100	12281	0	.103	11583	+2	.160	09885
.1001	08517	-1	.104	11485	+4	.170	12748
.1002	11648	+2	.105	12120	+2	.180	09200
.1003	11259	0	.108	11401	+3	.190	11795
.1004	12857	+4	.107	11894	-1	.200	13029
.1005	12073	+2	.108	11539	+2	.300	12775
.1006	12548	+4	.109	11145	+3	.400	11257
.1007	12977	+3	.110	13951	+2	.500	12803
.1008	12390	+4	.120	08343	-1	1	13231
.1009	12873	0	.130	11171	-1	2	12308
.101	12304	+3	.140	11220	+4	4	12311

Set Serial No. 130022      Material: Steel      Inspector: *S. Zeng*  
 Standard: ASME B89.1.9-2002      Standard reference temperature: 68°F (20°C)

## MANUFACTURER INSPECTION CERTIFICATE, FOR GAGE BLOCKS

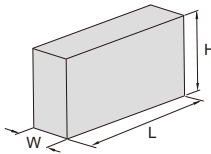

Dimension:

Size (L)	W	H
.02 ≤ L ≤ .394"	.354"	1.181"
L > .394"	.354"	1.378"

## STEEL GAGE BLOCK SETS



4102-81

- Made of alloy steel
- Meet ASME B89.1.9
- Supplied with manufacturer inspection certificate

Blocks per set	Gage blocks included in set			Part No.		
	Size (inch)	Step (inch)	Quantity	Grade 0	Grade AS-1	Grade AS-2
36	.05		1	4102-36	4102-136	4102-236
	.1001-.1009	.0001	9			
	.101-.109	.001	9			
	.11-.19	.01	9			
	.1-1.5	.1	5			
	1		1			
	2		1			
4		1				
81	.1001-.1009	.0001	9	4102-81	4102-181	4102-281
	.101-.149	.001	49			
	.05-.95	.05	19			
	1-4	1	4			

9

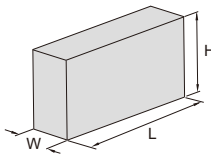

Dimension:

Size (L)	W	H
.02 ≤ L ≤ .394"	.354"	1.181"
L > .394"	.354"	1.378"

## CERAMIC GAGE BLOCK SETS



4005-281

- Made of ceramic, extremely wear resistance and corrosion resistance, excellent dimension stability
- Meet ASME B89.1.9
- Supplied with manufacturer inspection certificate

Blocks per set	Gage blocks included in set			Part No.		
	Size (inch)	Step (inch)	Quantity	Grade 0	Grade AS-1	Grade AS-2
36	.05		1	4005-36	4005-136	4005-236
	.1001-.1009	.0001	9			
	.101-.109	.001	9			
	.11-.19	.01	9			
	.1-1.5	.1	5			
	1		1			
	2		1			
4		1				
81	.1001-.1009	.0001	9	4005-81	4005-181	4005-281
	.101-.149	.001	49			
	.05-.95	.05	19			
	1-4	1	4			



## INDIVIDUAL STEEL GAGE BLOCKS

- Made of alloy steel
- Meet ASME B89.1.9
- Supplied with manufacturer inspection certificate



4112-A3

Part No. explanation:

4112-X□□□□□□

- A stands for grade 0
- B stands for grade AS-1
- C stands for grade AS-2

Part No. examples:

Size (L)	Grade	Part No.
.1"	0	4112-AD1
.95"	AS-1	4112-BD95
20"	AS-2	4112-C20

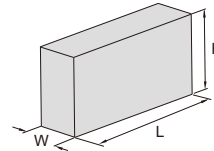

Dimension:

Size (L)	W	H
.02 ≤ L ≤ .394"	.354"	1.181"
L > .394"	.354"	1.378"

**CUSTOM-MADE**  
CAN SUPPLY ANY SIZES FROM .02" TO 40", SUCH AS 3.876"  
SIZE < 4": MOQ 6 PCS PER SIZE  
SIZE > 4": MOQ 3 PCS PER SIZE



9

Size (L)	Part No.	Size (L)	Part No.	Size (L)	Part No.	Size (L)	Part No.	Size (L)	Part No.
.1"	4112-XD1	.109"	4112-XD109	.127"	4112-XD127	.145"	4112-XD145	.8"	4112-XD8
.1001"	4112-XD1001	.11"	4112-XD11	.128"	4112-XD128	.146"	4112-XD146	.85"	4112-XD85
.1002"	4112-XD1002	.111"	4112-XD111	.129"	4112-XD129	.147"	4112-XD147	.9"	4112-XD9
.1003"	4112-XD1003	.112"	4112-XD112	.13"	4112-XD13	.148"	4112-XD148	.95"	4112-XD95
.1004"	4112-XD1004	.113"	4112-XD113	.131"	4112-XD131	.149"	4112-XD149	1"	4112-X1
.1005"	4112-XD1005	.114"	4112-XD114	.132"	4112-XD132	.15"	4112-XD15	2"	4112-X2
.1006"	4112-XD1006	.115"	4112-XD115	.133"	4112-XD133	.2"	4112-XD2	3"	4112-X3
.1007"	4112-XD1007	.116"	4112-XD116	.134"	4112-XD134	.25"	4112-XD25	4"	4112-X4
.1008"	4112-XD1008	.117"	4112-XD117	.135"	4112-XD135	.3"	4112-XD3	5"	4112-X5
.1009"	4112-XD1009	.118"	4112-XD118	.136"	4112-XD136	.35"	4112-XD35	6"	4112-X6
.101"	4112-XD101	.119"	4112-XD119	.137"	4112-XD137	.4"	4112-XD4	7"	4112-X7
.102"	4112-XD102	.12"	4112-XD12	.138"	4112-XD138	.45"	4112-XD45	8"	4112-X8
.103"	4112-XD103	.121"	4112-XD121	.139"	4112-XD139	.5"	4112-XD5	10"	4112-X10
.104"	4112-XD104	.122"	4112-XD122	.14"	4112-XD14	.55"	4112-XD55	12"	4112-X12
.105"	4112-XD105	.123"	4112-XD123	.141"	4112-XD141	.6"	4112-XD6	16"	4112-X16
.106"	4112-XD106	.124"	4112-XD124	.142"	4112-XD142	.65"	4112-XD65	20"	4112-X20
.107"	4112-XD107	.125"	4112-XD125	.143"	4112-XD143	.7"	4112-XD7		
.108"	4112-XD108	.126"	4112-XD126	.144"	4112-XD144	.75"	4112-XD75		

## MICROMETER INSPECTION GAGE BLOCK SET

- Made of alloy steel
- Meet ASME B89.1.9 grade AS-1
- Supplied with manufacturer inspection certificate



4107-E10

Part No.	Gage blocks included	Applicable micrometer
4107-E10	.105", .210", .315", .420", .500", .605", .710", .815", .920", .1.000"	0-1"

## GAGE BLOCK HOLDER

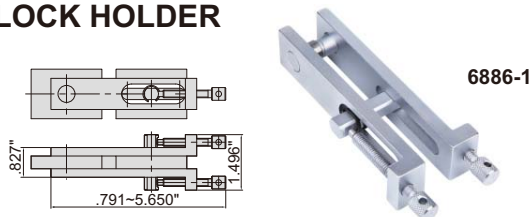

Part No.  
6886-1

## GAGE BLOCK HOLDER ACCESSORY



Part No.  
6886-A

- For gage blocks over 4" with clamping holes
- Optional accessory: gage block holder accessory, gage block accessory (part no. 6881)

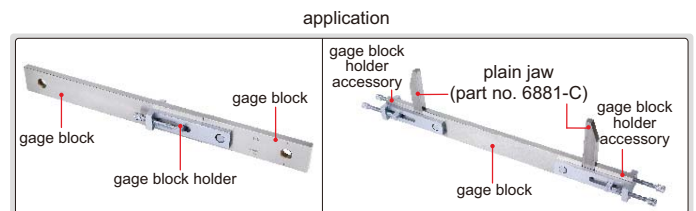

## GAGE BLOCK HOLDERS

- Made of aluminum
- To be used with individual steel gage blocks (part no. 4112) as Go and No-Go gage

Part No.	Applicable gage block size
6883-1	.06-.2"
6883-2	.2-.4"
6883-3	.4-.6"
6883-4	.6-.8"
6883-5	.8-1"



6883-4

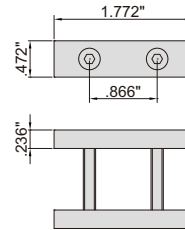

to be used as Go and No-Go gage



## CALIPER/HEIGHT GAGE CHECKERS



- To check calipers and height gages
- Constructed with steel gage blocks

check upper jaws of caliper



check lower jaws of caliper

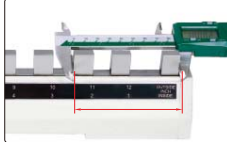

check height gage

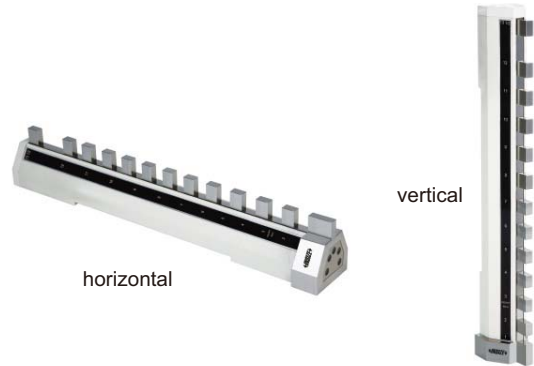
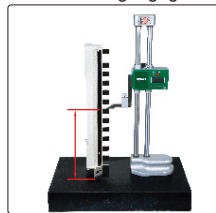

horizontal

vertical

6884-E12

height measurement

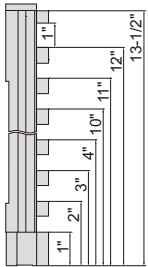

6884-E12

outside measurement

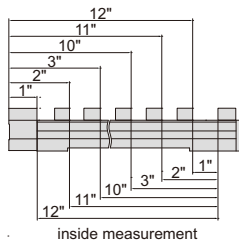

6884-E12

height measurement

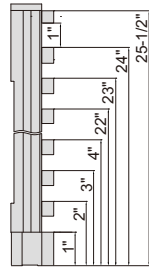

6884-E24

outside measurement

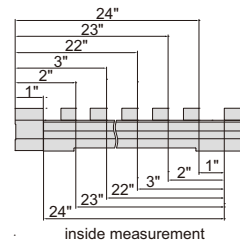

6884-E24

height measurement

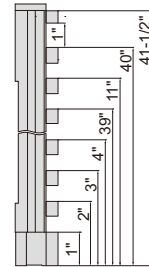

6884-E40

outside measurement

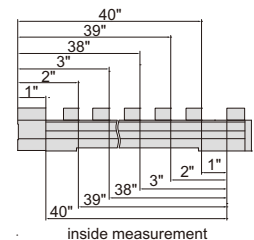

6884-E40

Part No.	Size	Range of inside measurement	Range of outside measurement	Range of height measurement	Accuracy
6884-E12 *	0-12"	1", 2", 3", 4", 5", 6", 7", 8", 9", 10", 11", 12"	1", 2", 3", 4", 5", 6", 7", 8", 9", 10", 11", 12"	1", 2", 3", 4", 5", 6", 7", 8", 9", 10", 11", 12", 13-1/2"	±200µin
6884-E24 *	0-24"	1", 2", 3", 4", 5", 6", 7", 8", 9", 10", 11", 12", 13", 14", 15", 16", 17", 18", 19", 20", 21", 22", 23", 24"	1", 2", 3", 4", 5", 6", 7", 8", 9", 10", 11", 12", 13", 14", 15", 16", 17", 18", 19", 20", 21", 22", 23", 24"	1", 2", 3", 4", 5", 6", 7", 8", 9", 10", 11", 12", 13", 14", 15", 16", 17", 18", 19", 20", 21", 22", 23", 24", 25-1/2"	±300µin
6884-E40 *	0-40"	1", 2", 3", 4", 5", 6", 7", 8", 9", 10", 11", 12", 13", 14", 15", 16", 17", 18", 19", 20", 21", 22", 23", 24", 25", 26", 27", 28", 29", 30", 31", 32", 33", 34", 35", 36", 37", 38", 39", 40"	1", 2", 3", 4", 5", 6", 7", 8", 9", 10", 11", 12", 13", 14", 15", 16", 17", 18", 19", 20", 21", 22", 23", 24", 25", 26", 27", 28", 29", 30", 31", 32", 33", 34", 35", 36", 37", 38", 39", 40"	1", 2", 3", 4", 5", 6", 7", 8", 9", 10", 11", 12", 13", 14", 15", 16", 17", 18", 19", 20", 21", 22", 23", 24", 25", 26", 27", 28", 29", 30", 31", 32", 33", 34", 35", 36", 37", 38", 39", 40", 41-1/2"	±300µin

\* Supplied with manufacturer inspection certificate

## GAGE BLOCK ACCESSORIES

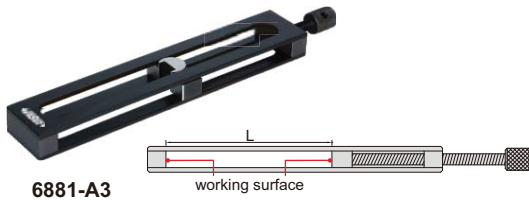

6881-A3

Part No.	Name	Clamping range * (L)
6881-A1	holder	0-1"
6881-A2	holder	1-2"
6881-A3	holder	2-4"
6881-A4	holder	4-8"
6881-A5	holder	8-12"
6881-A6**	holder	12-20"

\* The actual clamping range should deduct the width of jaws  
 \*\* Not suitable for base 6881-BE



6881-F

Part No.	Name	Remark
6881-F	scraper	made of carbide

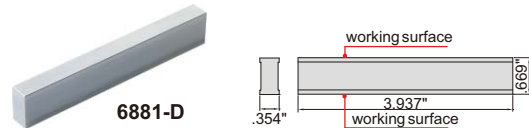

6881-D

Part No.	Name	Remark
6881-D	parallel jaw	made of carbide



6881-S17

### GAGE BLOCK ACCESSORY SET

Part No.	Mark
6881-S17	17 pcs (including the below items)

holder, 0-1" (part no. 6881-A1)	1 pc
holder, 1-2" (part no. 6881-A2)	1 pc
holder, 2-4" (part no. 6881-A3)	1 pc
holder, 4-8" (part no. 6881-A4)	1 pc
holder, 8-12" (part no. 6881-A5)	1 pc
base (part no. 6881-BE)	1 pc
plain jaw (part no. 6881-C)	1 pair
parallel jaw (part no. 6881-D)	1 pc
half round jaw, (part no. 6881-E1E)	1 pair
half round jaw, (part no. 6881-E2E)	1 pair
half round jaw, (part no. 6881-E3E)	1 pair
scraper (part no. 6881-F)	1 pc
centre point (part no. 6881-G)	1 pc

Part No.	Name
6881-BE	base



6881-BE

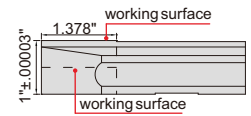

6881-E2E

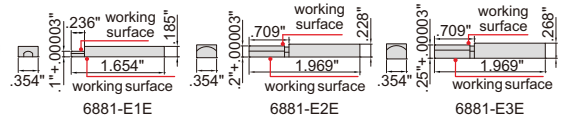

Part No.	Name	Size	Remark
6881-E1E	half round jaw	.1"	made of carbide, supplied in pair
6881-E2E	half round jaw	.2"	made of carbide, supplied in pair
6881-E3E	half round jaw	.25"	made of carbide, supplied in pair



6881-C

Part No.	Name	Remark
6881-C	plain jaw	made of carbide, supplied in pair



6881-G

Part No.	Name	Remark
6881-G	centre point	the tip is made of carbide



6881-H

Part No.	Name	Remark
6881-H	base for holder	supplied in pair

### application

(plain jaw+holder) set zero

(base+holder+scraper) measure height or scribe

(plain jaw+holder)

(plain jaw+holder+base for holder)

(half round jaw+holder) measure size A

Go No Go (plain jaw+parallel jaw+holder) Go and No Go inspection

(half round jaw+holder) measure inside diameter

(scraper+centre point+holder) scribe circle



**CUSTOM-MADE  
CAN SUPPLY ANY LENGTH, SUCH AS 3.1762"**

## CYLINDER GAGE BLOCKS

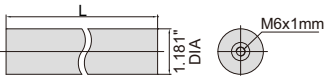

- Made of special alloy steel, hardness HRC64, high stability, wear resistance and easy combination
- Meet ASME B89.1.9, grade AS-1
- Can be connected with M6x1mm screw and combined to any sizes up to 150"



Part No.	Length (L)
4001-1E *	1"
4001-2E *	2"
4001-3E *	3"
4001-4E *	4"
4001-8E *	8"
4001-12E *	12"
4001-16E *	16"
4001-20E *	20"

\* Supplied with manufacturer inspection certificate

can be combined to any sizes up to 150"

Combination 1: combined by several standard size cylinder gage blocks and one custom size cylinder gage block  
For example: 20" (standard) +8" (standard) +1.0175" (custom) =29.0175"  
Note: in order to reduce cost, custom size should be within 4"



Combination 2: combined by standard size cylinder gage blocks and rectangular gage blocks  
For example: 20" (cylinder) +8" (cylinder) +.8" (rectangular)+.117" (rectangular) +.1005" (rectangular) =29.0175"



high stability in vertical position, suitable for checking height gages



connected with M6x1mm screw

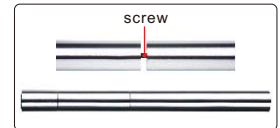

9

## INTERNAL BLOCKS

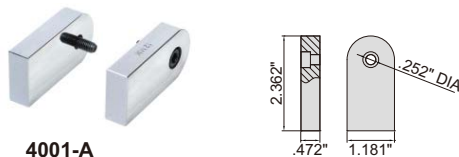

4001-A

- Can be attached to cylinder and rectangular gage blocks
- Made of special alloy steel, hardness HRC64, high stability, wear resistance and easy combination
- Supplied in a matched pair

Part No.	Size	Flatness
4001-A	.472"	8µin

Combination 1: combined by several standard size cylinder gage blocks and one custom size cylinder gage block  
For example: 20" (standard) +8" (standard) +1.0175" (custom) =29.0175"  
Note: in order to reduce cost, custom size should be within 4"



Combination 2: combined by standard size cylinder gage blocks and rectangular gage blocks  
For example: 20" (cylinder) +8" (cylinder) +2" (rectangular)-.75" (rectangular) -.132" (rectangular)-.1005" (rectangular) =29.0175"

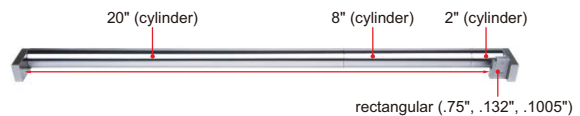

working with base

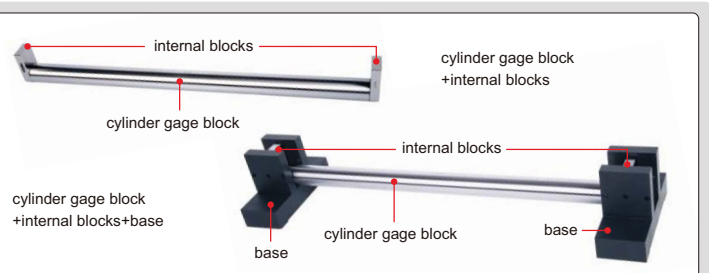

## BASE

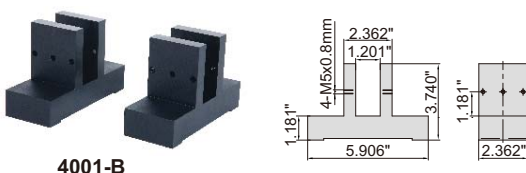

4001-B

Part No.	Remark
4001-B	supplied in pair



## ANGLE GAGE BLOCK SETS



4109-7A

- Standard for angle measurement
- Accuracy  $\pm 10''$

Part No.	Blocks per set	Angle	Step	Quantity
4109-7A	7	15°10'		1
		30°20'		1
		45°30'		1
		50°		1
		60°40'		1
		75°50'		1
		90°/90°/90°/90°		1
4109-36A	36	10°-20°	1°	11
		30°-70°	10°	5
		45°		1
		15°10'-15°50'	10'	5
		15°1'-15°9'	1'	9
		10°00'30"		1
		80°/81°/100°/99°		1
		89°10'/89°20'/90°50'/90°40'		1
		89°30'/89°40'/90°30'/90°20'		1
		90°/90°/90°/90°		1

## ANGLE GAGE BLOCKS

**INSIZE PLUS**

9

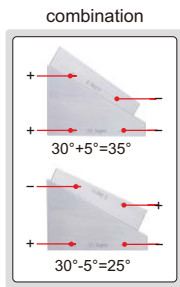

4002-15



set angle of plate



inspect angle



- Accuracy:  $\pm 2''$
- To inspect protractor, taper gage, index plate, index head and goniometer, can also be used to set angle
- Made of special alloy steel, hardness HRC64, high stability, wear resistance and easy combination
- Can be combined to any angle with interval 6 seconds after combination (6", 12", 18", ... , 360°)

Set

Part No.	Angle (α)	Total quantity
4002-13*	1°, 3°, 9°, 27°, 41°, 1', 3', 9', 27', 6", 18", 30", 90°/90°/90°/90°	13
4002-15*	1°, 3°, 5°, 15°, 30°, 45°, 1', 3', 5', 20', 30', 6", 12", 30", 90°/90°/90°/90°	15

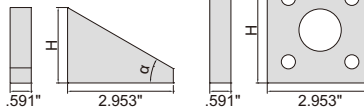

**INSPECTION CERTIFICATE**

Individual

Part No.	Angle (α)	H
4002-A1*	1°	.453"
4002-A3*	3°	.551"
4002-A5*	5°	.650"
4002-A9*	9°	.866"
4002-A15*	15°	1.201"
4002-A27*	27°	1.890"
4002-A30*	30°	2.106"
4002-A41*	41°	2.953"
4002-A45*	45°	3.307"
4002-B1*	1'	.394"
4002-B3*	3'	.394"
4002-B5*	5'	.394"
4002-B9*	9'	.394"
4002-B20*	20'	.394"
4002-B27*	27'	.394"
4002-B30*	30'	.394"
4002-C6*	6"	.394"
4002-C12*	12"	.394"
4002-C18*	18"	.394"
4002-C30*	30"	.394"
4002-D*	90°/90°/90°/90°	2.953"

\* Supplied with manufacturer inspection certificate

## PIN GAGE SETS



4162-111

- Class ZZ
- Made of alloy steel
- Hardness HRC60-62

Diameter (d)	Step	Pin gages per set	Part No.	
			Accuracy + .0002"	Accuracy - .0002"
.011~.060"	.001"	50	4162-111	4162-211
.061~.250"	.001"	190	4162-1161	4162-2161
.251~.500"	.001"	250	4162-1251	4162-2251
.501~.625"	.001"	125	4162-1501	4162-2501
.626~.750"	.001"	125	4162-1626	4162-2626
.751~.832"	.001"	82	4162-1751	4162-2751
.833~.916"	.001"	84	4162-1833	4162-2833
.917~1.000"	.001"	84	4162-1917	4162-2917

## PIN GAGE HANDLES

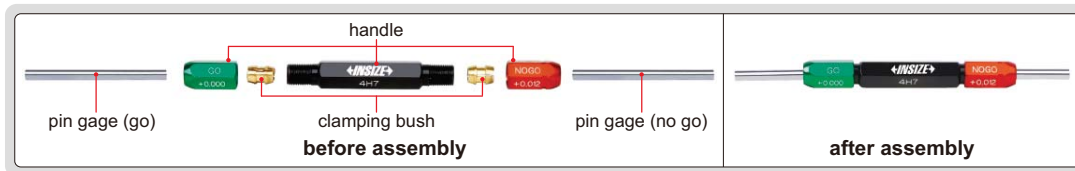

Handle



brass  
(.008~.281")



aluminum  
(.281~1.010")

clamping bush

- Wrench is needed to install pins
- Clamping bushes (.008~.281") are made of brass, clamping bushes (.281~1.010") are made of aluminum

Part No.	Applicable pin gage diameter	Including	
		Handle	Clamping bush
7341-0S	.008-.040"	1 pc	6 pairs (the clamping range are .008-.015", .015-.020", .020-.025", .025-.030", .030-.035", .035-.040")
7341-1S	.040-.075"	1 pc	7 pairs (the clamping range are .040-.045", .045-.050", .050-.055", .055-.060", .060-.065", .065-.070", .070-.075")
7341-2S	.075-.131"	1 pc	8 pairs (the clamping range are .075-.082", .082-.089", .089-.096", .096-.103", .103-.110", .110-.117", .117-.124", .124-.131")
7341-3S	.131-.180"	1 pc	7 pairs (the clamping range are .131-.138", .138-.145", .145-.152", .152-.159", .159-.166", .166-.173", .173-.180")
7341-4S	.180-.228"	1 pc	6 pairs (the clamping range are .180-.188", .188-.196", .196-.204", .204-.212", .212-.220", .220-.228")
7341-5S	.228-.281"	1 pc	6 pairs (the clamping range are .228-.236", .236-.244", .244-.252", .252-.261", .261-.271", .271-.281")

Part No.	Applicable pin gage diameter	Including	
		Handle	Clamping bush
7341-6S	.281-.341"	1 pc	6 pairs (the clamping range are .281-.291", .291-.301", .301-.311", .311-.321", .321-.331", .331-.341")
7341-7S	.341-.406"	1 pc	6 pairs (the clamping range are .341-.351", .351-.361", .361-.371", .371-.382", .382-.394", .394-.406")
7341-8S	.406-.465"	1 pc	4 pairs (the clamping range are .406-.420", .420-.435", .435-.450", .450-.465")
7341-9S	.465-.510"	1 pc	3 pairs (the clamping range are .465-.480", .480-.495", .495-.510")
7341-10S	.510-.579"	1 pc	4 pairs (the clamping range are .510-.532", .532-.547", .547-.563", .563-.579")
7341-11S	.579-.635"	1 pc	4 pairs (the clamping range are .579-.594", .594-.610", .610-.625", .625-.635")
7341-12S	.635-.704"	1 pc	4 pairs (the clamping range are .635-.656", .656-.672", .672-.688", .688-.704")
7341-13S	.704-.760"	1 pc	4 pairs (the clamping range are .704-.719", .719-.735", .735-.750", .750-.760")
7341-15S	.760-1.010"	1 pc	8 pairs (the clamping range are .760-.781", .781-.812", .812-.843", .843-.875", .875-.907", .907-.937", .937-.968", .968-1.010")

9

Part No.	Size (mm)	Part No.	Size (mm)	Part No.	Size (mm)
4130-2*	M2x0.4	4130-10*	M10x1.5	4130-39*	M39x4
4130-2D2*	M2.2x0.45	4130-11*	M11x1.5	4130-42*	M42x4.5
4130-2D5*	M2.5x0.45	4130-12*	M12x1.75	4130-45*	M45x4.5
4130-3*	M3x0.5	4130-14*	M14x2	4130-48*	M48x5
4130-3D5*	M3.5x0.6	4130-16*	M16x2	4130-52*	M52x5
4130-4*	M4x0.7	4130-18*	M18x2.5	4130-56*	M56x5.5
4130-5*	M5x0.8	4130-20*	M20x2.5	4130-60*	M60x5.5
4130-6*	M6x1	4130-22*	M22x2.5	4130-33*	M33x3.5
4130-7*	M7x1	4130-24*	M24x3	4130-36*	M36x4
4130-8*	M8x1.25	4130-27*	M27x3		
4130-9*	M9x1.25	4130-30*	M30x3.5		

\* Supplied with manufacturer inspection certificate

## METRIC THREAD PLUG GAGES

ATTENTION:  
BASIC MODEL



4130-10

- Supplied with Go and No-Go end
- Class 6H
- Standard ISO1502

## METRIC THREAD RING GAGES

- Go and No-Go gages are supplied separately
- Class 6g
- Standard ISO1502



4120-16



4120-16N

**INSPECTION CERTIFICATE**

**ATTENTION: BASIC MODEL**

Part No. (GO)	Part No. (NOGO)	Size (mm)
4120-2*	4120-2N*	M2x0.4
4120-2D2*	4120-2D2N*	M2.2x0.45
4120-2D5*	4120-2D5N*	M2.5x0.45
4120-3*	4120-3N*	M3x0.5
4120-3D5*	4120-3D5N*	M3.5x0.6
4120-4*	4120-4N*	M4x0.7
4120-5*	4120-5N*	M5x0.8
4120-6*	4120-6N*	M6x1
4120-7*	4120-7N*	M7x1
4120-8*	4120-8N*	M8x1.25
4120-9*	4120-9N*	M9x1.25

Part No. (GO)	Part No. (NOGO)	Size (mm)
4120-10*	4120-10N*	M10x1.5
4120-11*	4120-11N*	M11x1.5
4120-12*	4120-12N*	M12x1.75
4120-14*	4120-14N*	M14x2
4120-16*	4120-16N*	M16x2
4120-18*	4120-18N*	M18x2.5
4120-20*	4120-20N*	M20x2.5
4120-22*	4120-22N*	M22x2.5
4120-24*	4120-24N*	M24x3
4120-27*	4120-27N*	M27x3
4120-30*	4120-30N*	M30x3.5

Part No. (GO)	Part No. (NOGO)	Size (mm)
4120-33*	4120-33N*	M33x3.5
4120-36*	4120-36N*	M36x4
4120-39*	4120-39N*	M39x4
4120-42*	4120-42N*	M42x4.5
4120-45*	4120-45N*	M45x4.5
4120-48*	4120-48N*	M48x5
4120-52*	4120-52N*	M52x5
4120-56*	4120-56N*	M56x5.5
4120-60*	4120-60N*	M60x5.5

9

\* Supplied with manufacturer inspection certificate

## AMERICAN STANDARD THREAD PLUG GAGES

**INSPECTION CERTIFICATE**

**ATTENTION: BASIC MODEL**

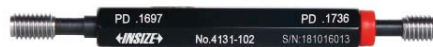

4131-102

- Supplied with Go and No-Go end
- Class 2B
- Standard ANSI B1.2

Part No.	Size	Part No.	Size
4131-41*	4-40UNC	4131-1A2*	1/2-20UNF
4131-61*	6-32UNC	4131-9D2*	9/16-18UNF
4131-81*	8-32UNC	4131-5C1*	5/8-11UNC
4131-102*	10-32UNF	4131-5C2*	5/8-18UNF
4131-1B1*	1/4-20UNC	4131-3B1*	3/4-10UNC
4131-1B2*	1/4-28UNF	4131-3B2*	3/4-16UNF
4131-5D1*	5/16-18UNC	4131-3C2*	3/8-24UNF
4131-5D2*	5/16-24UNF	4131-7D2*	7/16-20UNF
4131-3C1*	3/8-16UNC	4131-1A1*	1/2-13UNC

\* Supplied with manufacturer inspection certificate

## AMERICAN STANDARD THREAD RING GAGES

**INSPECTION CERTIFICATE**

**ATTENTION: BASIC MODEL**



front



back

4121-1B1



front



back

4121-1B1N

- Class 2A
- Standard ANSI B1.2

Part No. (GO)	Part No. (NOGO)	Size
4121-41*	4121-41N*	4-40UNC
4121-61*	4121-61N*	6-32UNC
4121-81*	4121-81N*	8-32UNC
4121-102*	4121-102N*	10-32UNF
4121-1B1*	4121-1B1N*	1/4-20UNC
4121-1B2*	4121-1B2N*	1/4-28UNF

Part No. (GO)	Part No. (NOGO)	Size
4121-5D1*	4121-5D1N*	5/16-18UNC
4121-5D2*	4121-5D2N*	5/16-24UNF
4121-3C1*	4121-3C1N*	3/8-16UNC
4121-3C2*	4121-3C2N*	3/8-24UNF
4121-7D2*	4121-7D2N*	7/16-20UNF
4121-1A1*	4121-1A1N*	1/2-13UNC

Part No. (GO)	Part No. (NOGO)	Size
4121-1A2*	4121-1A2N*	1/2-20UNF
4121-9D2*	4121-9D2N*	9/16-18UNF
4121-5C1*	4121-5C1N*	5/8-11UNC
4121-5C2*	4121-5C2N*	5/8-18UNF
4121-3B1*	4121-3B1N*	3/4-10UNC
4121-3B2*	4121-3B2N*	3/4-16UNF

\* Supplied with manufacturer inspection certificate

**IP54**  
WATERPROOF

**ABSOLUTE**  
LEVEL

**AUTOMATIC**  
BACKLIGHT

## WATERPROOF ELECTRONIC PROTRACTOR (HEAVY DUTY)

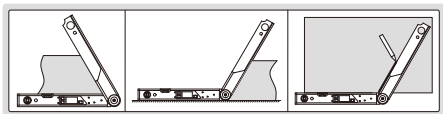

- Suitable for setting horizontal and vertical mitre angles of cutting machine
- Buttons: ON/OFF, HOLD/SUP, SPR/CNR/MTR/BVL
- IP54 dust/waterproof
- With transverse and longitudinal vials
- 2xAAA batteries
- Absolute level, zero setting is not needed when batteries are replaced
- Backlight turns off in one minute after no data changing, automatic power off in 5 minutes



2174-225

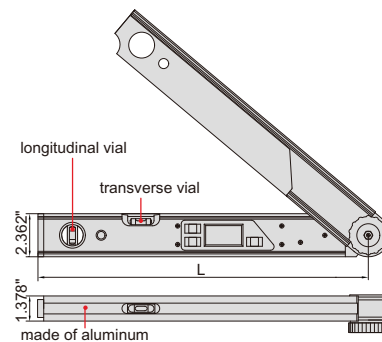

Part No.	Size (L)	Range	Resolution	Accuracy
2174-225	18.11"	0-225°	0.05°	±0.10°

## ELECTRONIC PROTRACTOR

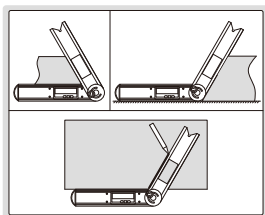
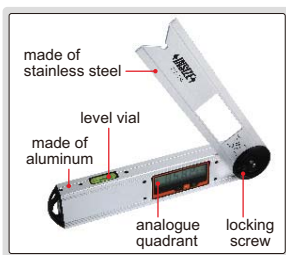

- Buttons: on/off, hold (keep the reading), zero, ABS (absolute and incremental measurement)
- Fix the locking screw at 4 positions for different measuring ranges: 0°~225°, -225°~0°, -45°~180°, -180°~45°
- Remove the locking screw for 360° range
- With level vial
- Battery CR2032, automatic power off



2171-250

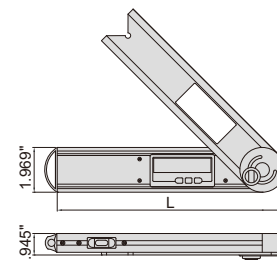

Part No.	Size (L)	Range	Resolution	Accuracy
2171-250	10"	0-360°	0.05°	±0.15°

## ELECTRONIC PROTRACTORS

- Buttons: on/off, zero
- With clamping screw to lock the blades
- Graduation of blade: 1mm and 1/32"
- Made of stainless steel
- CR2032 battery
- Automatic power off

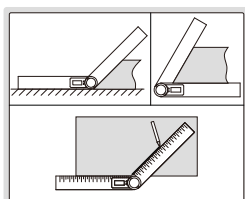

2176-300

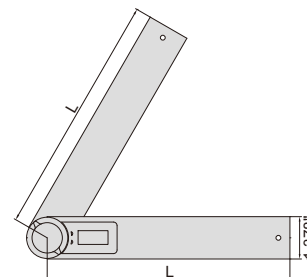

Part No.	Size (L)	Range	Resolution	Accuracy
2176-200	8"	0-360°	0.1°	±0.3°
2176-300	12"	0-360°	0.1°	±0.3°

## PROTRACTOR

- Made of stainless steel
- Satin chrome plated scale
- With clamping screw

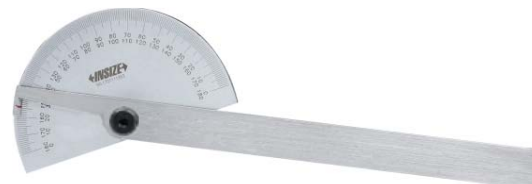
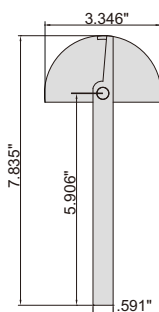

4780-85

Part No.	Range	Graduation	Accuracy
4780-85	0-180°	1°	±0.3°



## PROTRACTOR

4 working edges

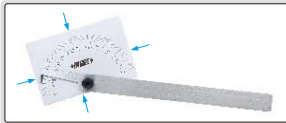

4781-85

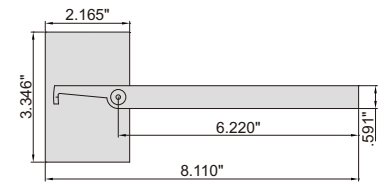

- Made of stainless steel
- Satin chrome plated scale
- With clamping screw

Part No.	Range	Graduation	Accuracy
4781-85	0-180°	1°	±0.3°

## PROTRACTORS

- Graduation: 1°
- Made of stainless steel (4799-1300 is made of carbon steel)
- Satin chrome plated scale
- With clamping screw

Part No.	Size (AxB)	Range	Accuracy	L	C
4799-180	3.1x4.7"	0-180°	±0.3°	6.614"	.433"
4799-1120	4.7x5.9"	0-180°	±0.3°	8.661"	.551"
4799-1150	5.9x7.9"	0-180°	±0.3°	11.220"	.630"
4799-1200	7.9x11.8"	0-180°	±0.3°	16.260"	.787"
4799-1300	11.8x19.7"	0-180°	±0.3°	26.575"	1.181"



4799-180

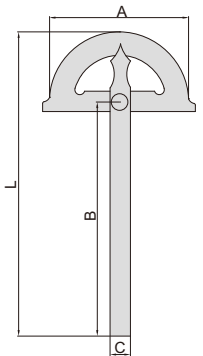

10

## PROTRACTORS

- Graduation: 1°
- Made of carbon steel
- Satin chrome plated
- With clamping screw
- The blade is moveable

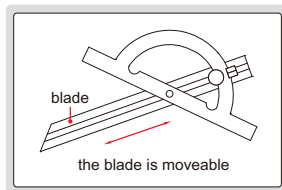

4797-100

Part No.	Size (AxB)	Range	Accuracy	C
4797-100	3.9x5.9"	10-170°	±0.3°	.709"
4797-150	5.9x11.8"	10-170°	±0.3°	.866"
4797-200	7.9x15.7"	10-170°	±0.3°	.945"
4797-250	9.8x19.7"	10-170°	±0.3°	1.102"
4797-300	11.8x23.6"	10-170°	±0.3°	1.260"

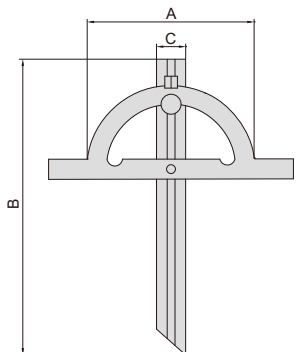

## PROTRACTOR

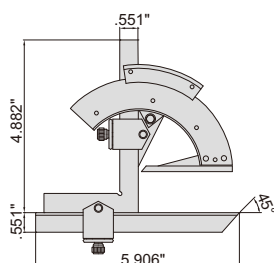

- Made of stainless steel
- Satin chrome plated scale



2374-320

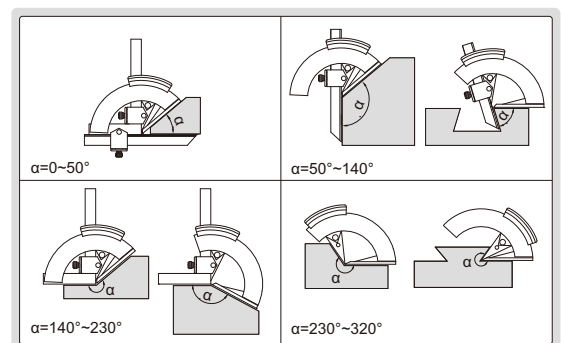

Part No.	Range	Graduation	Accuracy
2374-320	0-320°	2'	±2'

clamp for height gages (optional)

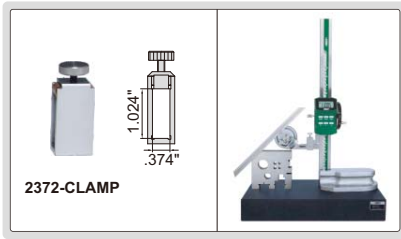

- Parallax-free reading
- Made of stainless steel
- Optional accessory: clamp (part no. **2372-CLAMP**), suitable for height gages **1156**, **1351** and **1250**

Part No.	Range	Graduation	Accuracy
<b>2372-360</b>	0-360°	5'	±5'

## UNIVERSAL PROTRACTOR

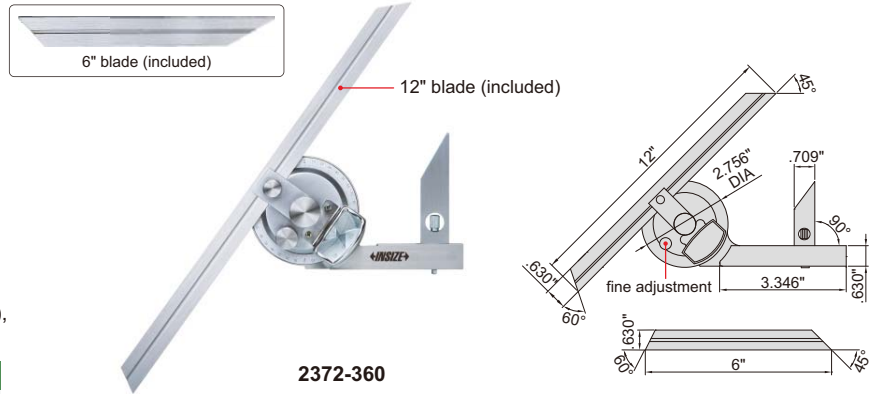

**2372-360**

clamp for height gages (optional)

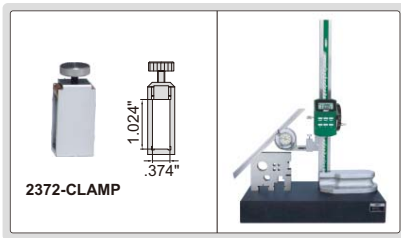

- Made of stainless steel
- Optional accessory: clamp (part no. **2372-CLAMP**), suitable for height gages **1156**, **1351** and **1250**

Part No.	Range	Graduation	Accuracy
<b>2373-360</b>	0-360°	5'	±5'

## DIAL PROTRACTOR

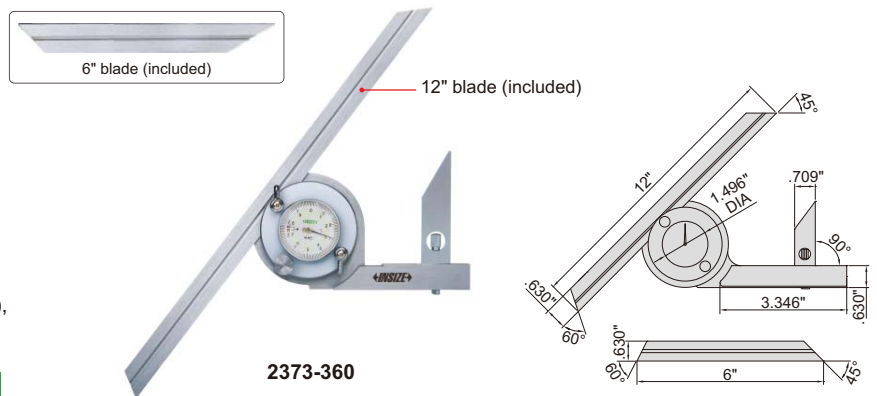

**2373-360**

DATA OUTPUT

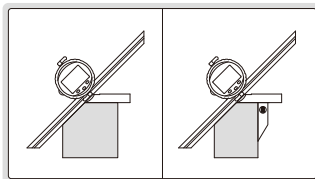

- Display in degree (for example 32.655°) and degree/minute/second (for example 32°39'30")
- SET button: preset the reading, change measuring direction
- MODE button: choose 0~90°, 0~180° or 0~360° display
- ZERO/ON/OFF button: zero and power on/off
- Battery CR2032, automatic power off
- Data output
- Supplied with square to set 90°
- Made of stainless steel
- Optional accessory: data output cable (part no. **7306-40**, **7302-SPC3A**, **7305-SPC1A**, **7305-C01**), clamp (part no. **2372-CLAMP**), suitable for height gages **1156**, **1351** and **1250**

Part No.	Range	Resolution	Accuracy
<b>2172-360A</b>	0-360°	10"/0.005°	±5'

## ELECTRONIC PROTRACTOR



**2172-360A**

clamp for height gages (optional)

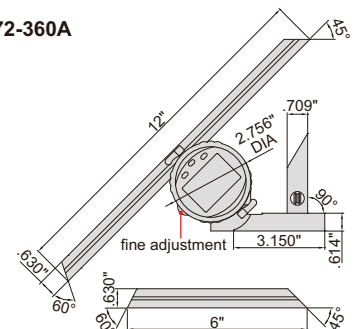
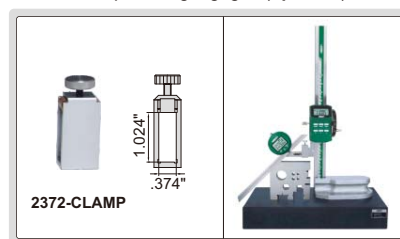

## PERPENDICULARITY TESTERS



- Optional accessory: dial test indicators, cylinder square (part no. 4710, for calibration), granite square (part no. 4141, for calibration)

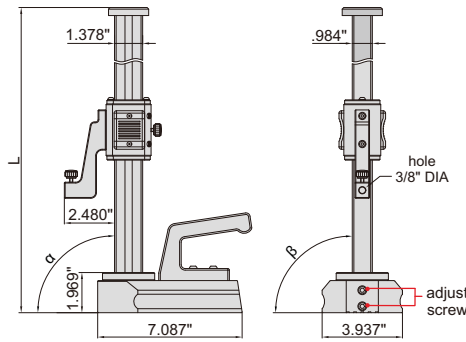

dial test indicator is not included

Part No.	Range (H)	Perpendicularity ( $\alpha$ )	Side perpendicularity ( $\beta$ )	L
4770-300E	0-12"	118 $\mu$ in	394 $\mu$ in	18.110"
4770-600E	0-24"	197 $\mu$ in	787 $\mu$ in	29.921"

## CYLINDER SQUARES



10

- Made of special alloy steel, hardness HRC58-60
- The handle can be removed

Part No.	Length (L)	Squareness
4710-200*	8"	39 $\mu$ in
4710-300*	12"	59 $\mu$ in

\* Supplied with manufacturer inspection certificate

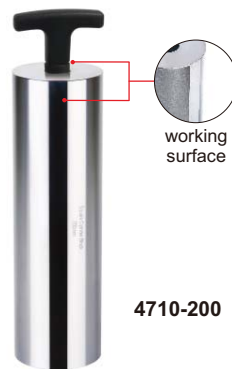

4710-200

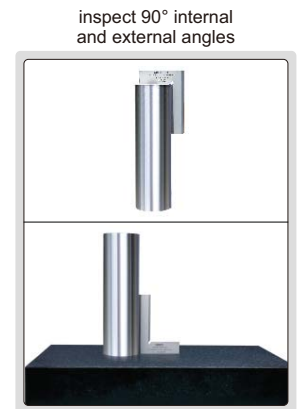
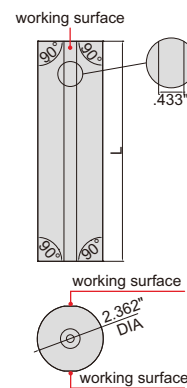

## GRANITE SQUARES

CUSTOM-MADE  
SUPPLY SPECIAL SIZES ACCORDING  
TO CUSTOMER'S REQUEST

Part No.	Size (HxW)	Flatness of A	Flatness of B	Squareness of A to B	D
4141-250	9.8x6.3"	39 $\mu$ in	39 $\mu$ in	79 $\mu$ in	.984"
4141-400	15.7x9.8"	59 $\mu$ in	39 $\mu$ in	118 $\mu$ in	1.575"
4141-630	24.8x15.7"	79 $\mu$ in	59 $\mu$ in	157 $\mu$ in	2.480"

4141-250

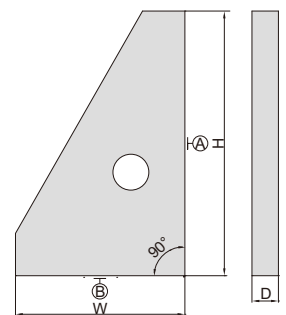

## GRANITE SQUARE

CUSTOM-MADE  
SUPPLY SPECIAL SIZES ACCORDING  
TO CUSTOMER'S REQUEST

Part No.	Size (HxW)	Flatness of A, B, C and D	Squareness and parallelism between A, B, C and D
4144-315	12.4x12.4"	43 $\mu$ in	102 $\mu$ in



4144-315

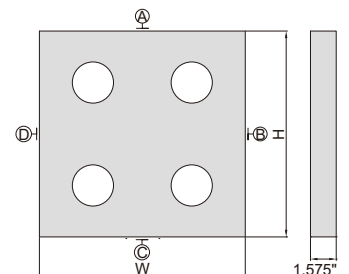

## GRANITE SQUARE WITH V GROOVE

- Parallelism and squareness of A, B, C, D, E and F: 236µin
- Parallelism and squareness of V groove to A, B, C, D, E and F: 236µin

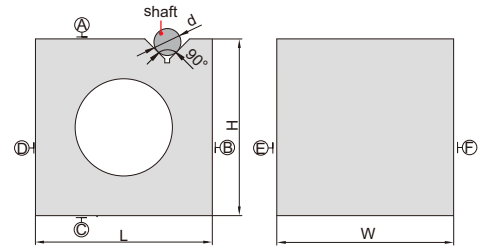

4142-200

Part No.	Size (LxWxH)	Range of shaft (d)
4142-200	7.9x7.9x7.9"	.35-2.76" DIA

## 90° TOOL MAKER SQUARES

- DIN875 grade 00
- Beveled edge for inside measurement
- Made of hardened stainless steel



4794-040

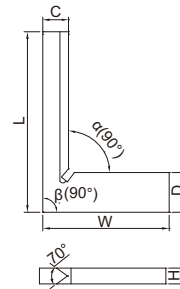

Part No.	Size (LxW)	Squareness		C	D	H
		Inside (α)	Outside (β)			
4794-025	1.0x.8"	87µin	91µin	.157"	.256"	.138"
4794-040	1.6x1.1"	91µin	94µin	.217"	.335"	.138"

## 90° BEVELED EDGE SQUARES

- Satin chrome plating
- Beveled edges for inside and outside measurement
- Made of hardened stainless steel



4790-0100

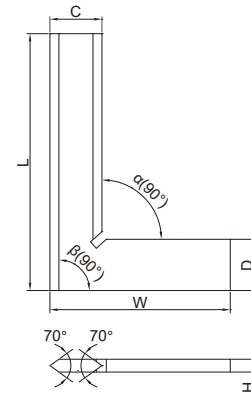

### DIN875 grade 00

Part No.	Size (LxW)	Squareness		C	D	H
		Inside (α)	Outside (β)			
4790-050	2.0x1.6"	94µin	98µin	.512"	.512"	.157"
4790-075	3.0x2.0"	102µin	110µin	.591"	.591"	.157"
4790-0100	3.9x2.8"	110µin	118µin	.787"	.787"	.197"
4790-0150	5.9x3.9"	126µin	138µin	1.181"	1.181"	.236"
4790-0200	7.9x5.1"	146µin	157µin	1.339"	1.339"	.276"
4790-0250	9.8x6.5"	165µin	177µin	1.378"	1.378"	.276"
4790-0300	11.8x7.9"	181µin	197µin	1.575"	1.575"	.315"

### DIN875 grade 0

Part No.	Size (LxW)	Squareness		C	D	H
		Inside (α)	Outside (β)			
4790-500	2.0x1.6"	236µin	236µin	.512"	.512"	.157"
4790-750	3.0x2.0"	236µin	276µin	.591"	.591"	.157"
4790-1000	3.9x2.8"	276µin	276µin	.787"	.787"	.197"
4790-1500	5.9x3.9"	276µin	315µin	1.181"	1.181"	.236"
4790-2000	7.9x5.1"	315µin	354µin	1.339"	1.339"	.276"
4790-2500	9.8x6.5"	354µin	394µin	1.378"	1.378"	.276"
4790-3000	11.8x7.9"	394µin	433µin	1.575"	1.575"	.315"



## 90° FLAT EDGE SQUARES

- DIN875 grade 0
- Made of hardened stainless steel

Part No.	Size (LxW)	Squareness		C	D	H
		Inside ( $\alpha$ )	Outside ( $\beta$ )			
4791-50	2.0x1.6"	236 $\mu$ in	236 $\mu$ in	.591"	.591"	.157"
4791-75	3.0x2.0"	236 $\mu$ in	276 $\mu$ in	.591"	.591"	.157"
4791-100	3.9x2.8"	276 $\mu$ in	276 $\mu$ in	.787"	.787"	.197"
4791-150	5.9x3.9"	276 $\mu$ in	315 $\mu$ in	1.181"	1.181"	.236"
4791-200	7.9x5.1"	315 $\mu$ in	354 $\mu$ in	1.181"	1.181"	.276"
4791-250	9.8x6.5"	354 $\mu$ in	394 $\mu$ in	1.378"	1.378"	.276"
4791-300	11.8x7.9"	394 $\mu$ in	433 $\mu$ in	1.575"	1.575"	.315"



4791-100

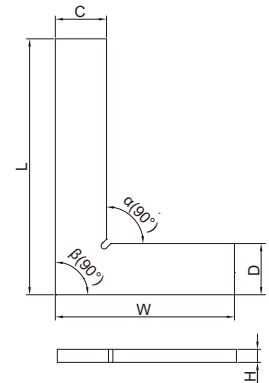

## 90° FLAT EDGE SQUARES WITH WIDE BASE

- DIN875 grade 0
- Made of hardened stainless steel

Part No.	Size (LxW)	Squareness		C	D	H	E
		Inside ( $\alpha$ )	Outside ( $\beta$ )				
4793-50	2.0x1.6"	236 $\mu$ in	236 $\mu$ in	.512"	.512"	.157"	.512"
4793-75	3.0x2.0"	236 $\mu$ in	276 $\mu$ in	.591"	.591"	.157"	.591"
4793-100	3.9x2.8"	276 $\mu$ in	276 $\mu$ in	.787"	.787"	.197"	.787"
4793-150	5.9x3.9"	276 $\mu$ in	315 $\mu$ in	1.181"	1.181"	.236"	1.181"
4793-200	7.9x5.1"	315 $\mu$ in	354 $\mu$ in	1.181"	1.181"	.276"	1.181"
4793-250	9.8x6.5"	354 $\mu$ in	394 $\mu$ in	1.378"	1.378"	.276"	1.378"
4793-300	11.8x7.9"	394 $\mu$ in	433 $\mu$ in	1.575"	1.575"	.315"	1.575"



4793-100

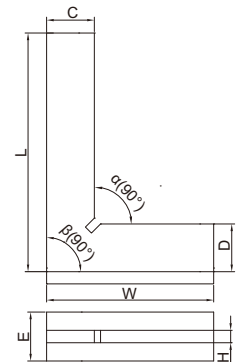

## 90° FLAT EDGE SQUARES WITH WIDE BASE

- DIN875 grade 0
- Made of hardened stainless steel

Part No.	Size (LxW)	Squareness		C	D	H	E
		Inside ( $\alpha$ )	Outside ( $\beta$ )				
4792-50	2.0x1.6"	236 $\mu$ in	236 $\mu$ in	.472"	.472"	.118"	.394"
4792-75	3.0x2.0"	236 $\mu$ in	276 $\mu$ in	.551"	.551"	.118"	.394"
4792-100	3.9x2.8"	276 $\mu$ in	276 $\mu$ in	.709"	.709"	.118"	.394"
4792-150	5.9x3.9"	315 $\mu$ in	315 $\mu$ in	.866"	.866"	.157"	.472"
4792-200	7.9x5.1"	354 $\mu$ in	354 $\mu$ in	.984"	.984"	.157"	.472"



4792-100

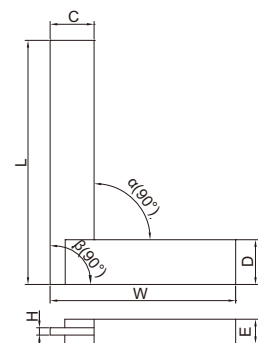

## 90° BEVELED EDGE SQUARES WITH WIDE BASE

- DIN875 grade 0
- Beveled edges for inside and outside measurement
- Made of hardened stainless steel

Part No.	Size (LxW)	Squareness		C	D	H	E
		Inside ( $\alpha$ )	Outside ( $\beta$ )				
4795-50	2.0x1.6"	236 $\mu$ in	236 $\mu$ in	.472"	.472"	.118"	.394"
4795-75	3.0x2.0"	236 $\mu$ in	276 $\mu$ in	.551"	.551"	.118"	.394"
4795-100	3.9x2.8"	276 $\mu$ in	276 $\mu$ in	.709"	.709"	.118"	.394"
4795-150	5.9x3.9"	315 $\mu$ in	315 $\mu$ in	.866"	.866"	.157"	.472"
4795-200	7.9x5.1"	354 $\mu$ in	354 $\mu$ in	.984"	.984"	.157"	.472"

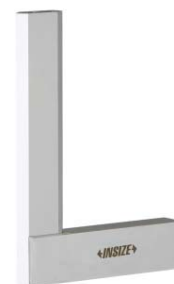

4795-100

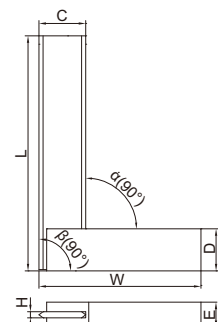



ATTENTION: NO ANTI-RUST TREATMENT, NOT HARDEND

ATTENTION: LOW ACCURACY

## MACHINIST SQUARES WITH WIDE BASE

Part No.	Size (LxW)	Squareness		C	D	H	E
		Inside ( $\alpha$ )	Outside ( $\beta$ )				
4707-50	2.0x1.6"	.95mil	.98mil	.630"	.472"	.118"	.354"
4707-75	3.0x2.0"	1.02mil	1.10mil	.630"	.630"	.118"	.354"
4707-100	3.9x2.8"	1.10mil	1.18mil	.748"	.748"	.118"	.472"
4707-150	6x4"	1.30mil	1.38mil	.984"	.984"	.118"	.630"
4707-200	8x5"	1.46mil	1.58mil	1.181"	1.260"	.157"	.630"
4707-250	10x6"	1.65mil	1.77mil	1.181"	1.260"	.157"	.748"
4707-300	12x8"	1.85mil	1.97mil	1.260"	1.260"	.157"	.748"
4707-400	16x10"	2.21mil	2.36mil	1.496"	1.496"	.197"	.866"
4707-500	20x12"	2.56mil	2.76mil	1.772"	1.969"	.236"	.984"
4707-600	24x14"	2.95mil	3.15mil	1.969"	1.969"	.236"	1.181"
4707-750	30x16"	3.54mil	3.74mil	2.165"	2.165"	.236"	1.969"
4707-900	35x20"	4.06mil	4.33mil	2.559"	2.953"	.354"	1.969"
4707-1000	39x22"	4.45mil	4.72mil	2.559"	2.953"	.354"	1.969"



4707-100

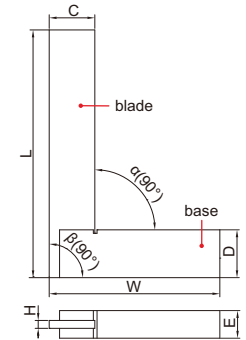

- Economic model
- DIN875 grade 2
- Made of carbon steel, no anti-rust treatment, not hardend

## ADJUSTABLE SQUARE

- The straight edge can move and can be locked by the clamping screw
- Made of hardened stainless steel

Part No.	Squareness (a, b, c, d)
4701-1	276 $\mu$ m

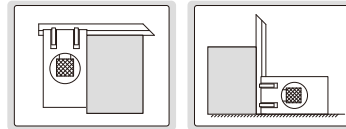

4701-1

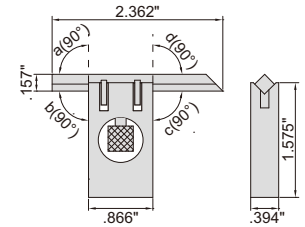

10

## 45° SQUARES

- Made of hardened stainless steel

Part No.	Size (LxW)	Accuracy		C	D	H
		Inside ( $\alpha$ )	Outside ( $\beta$ )			
4745-1100	3.9x2.8"	1.06mil	1.18mil	.787"	.787"	.197"
4745-1120	4.7x3.1"	1.14mil	1.26mil	.787"	.787"	.197"
4745-1150	5.9x3.9"	1.26mil	1.38mil	.787"	.787"	.197"
4745-1200	7.9x5.1"	1.42mil	1.58mil	.984"	.984"	.197"



4745-1100

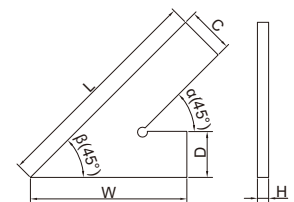

## 45° SQUARES WITH WIDE BASE

- Made of hardened stainless steel

Part No.	Size (LxW)	Accuracy		C	D	H	E
		Inside ( $\alpha$ )	Outside ( $\beta$ )				
4747-100	3.9x2.8"	1.06mil	1.22mil	.787"	.787"	.197"	.787"
4747-120	4.7x3.1"	1.14mil	1.30mil	.787"	.787"	.197"	.787"
4747-150	5.9x3.9"	1.26mil	1.42mil	.787"	.787"	.197"	.787"
4747-200	7.9x5.1"	1.42mil	1.61mil	.984"	.984"	.197"	.984"



4747-100

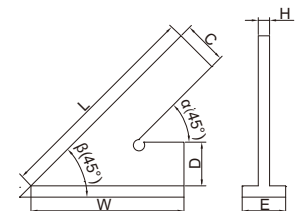

## 60° SQUARES

- Made of hardened stainless steel

Part No.	Size (LxW)	Accuracy		C	D	H
		Inside ( $\alpha$ )	Outside ( $\beta$ )			
4760-1100	3.9x2.8"	1.10mil	1.18mil	.787"	.787"	.197"
4760-1120	4.7x3.1"	1.18mil	1.26mil	.787"	.787"	.197"
4760-1150	5.9x3.9"	1.26mil	1.38mil	.787"	.787"	.197"
4760-1200	7.9x5.1"	1.46mil	1.58mil	.984"	.984"	.197"

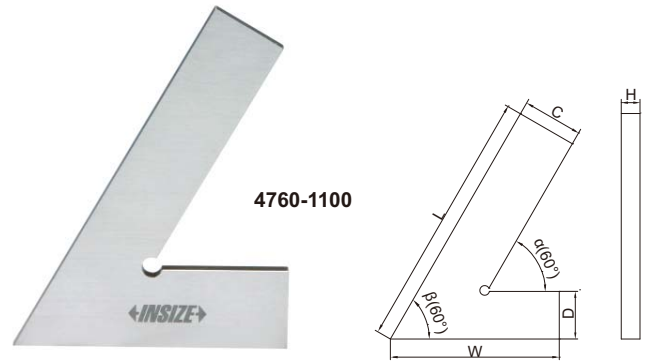

## 60° SQUARES WITH WIDE BASE

- Made of hardened stainless steel

Part No.	Size (LxW)	Accuracy		C	D	H	E
		Inside ( $\alpha$ )	Outside ( $\beta$ )				
4762-100	3.9x2.8"	1.10mil	1.22mil	.787"	.787"	.197"	.787"
4762-120	4.7x3.1"	1.18mil	1.30mil	.787"	.787"	.197"	.787"
4762-150	5.9x3.9"	1.30mil	1.42mil	.787"	.787"	.197"	.787"
4762-200	7.9x5.1"	1.46mil	1.61mil	.984"	.984"	.197"	.984"

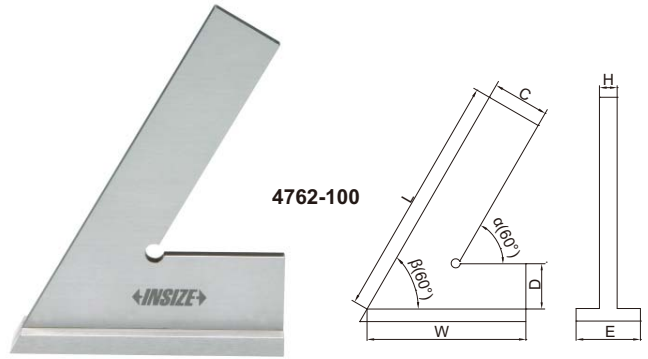

## 120° SQUARES

- Made of hardened stainless steel

Part No.	Size (LxW)	Accuracy		C	D	H
		Inside ( $\alpha$ )	Outside ( $\beta$ )			
4706-150	2.0x2.0"	.95mil	.98mil	.591"	.591"	.197"
4706-175	3.0x3.0"	1.02mil	1.10mil	.787"	.787"	.197"
4706-1100	3.9x3.9"	1.14mil	1.18mil	.787"	.787"	.197"
4706-1150	5.9x5.9"	1.34mil	1.38mil	.984"	.984"	.197"
4706-1200	7.9x7.9"	1.50mil	1.58mil	1.181"	1.181"	.276"

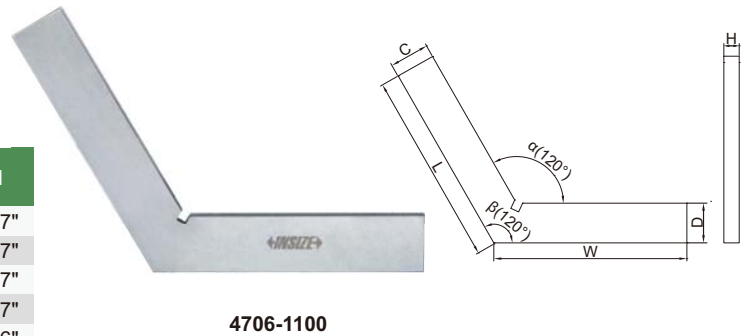

## 135° SQUARES WITH WIDE BASE

- Made of hardened stainless steel

Part No.	Size (LxW)	Accuracy		C	D	H	E
		Inside ( $\alpha$ )	Outside ( $\beta$ )				
4754-3100	3.9x2.8"	1.14mil	1.22mil	.787"	.787"	.197"	.787"
4754-3120	4.7x3.1"	1.22mil	1.30mil	.787"	.787"	.197"	.787"
4754-3150	5.9x3.9"	1.34mil	1.42mil	.787"	.787"	.197"	.787"
4754-3200	7.9x5.1"	1.54mil	1.61mil	1.181"	1.181"	.276"	1.181"
4754-3250	9.8x6.5"	1.73mil	1.81mil	1.181"	1.181"	.276"	1.181"
4754-3300	11.8x6.9"	1.93mil	2.01mil	1.378"	1.378"	.276"	1.378"

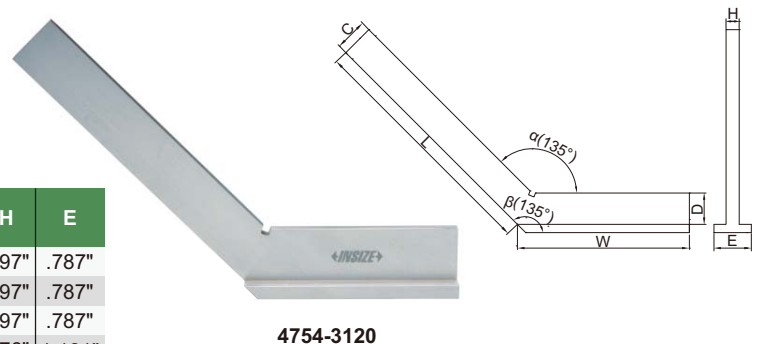

Part No.	Size (L)	Straightness	W	H
4700-50	2.0"	87µin	.197"	.787"
4700-75	3.0"	91µin	.197"	.984"
4700-100	3.9"	94µin	.197"	.984"
4700-125	4.9"	98µin	.236"	1.181"
4700-150	5.9"	102µin	.236"	1.181"
4700-200	7.9"	110µin	.236"	1.181"
4700-250	9.8"	118µin	.315"	1.575"
4700-300	11.8"	126µin	.315"	1.575"
4700-400	15.7"	142µin	.394"	1.969"
4700-500	19.7"	157µin	.394"	1.969"

### STRAIGHT EDGES



4700-100

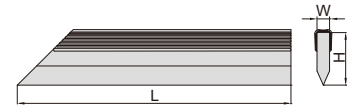

- DIN874
- Beveled edge
- Made of hardened stainless steel
- Satin chrome plating

### SQUARE SET

- Includes:
  - 90° tool maker square 1.0x.8" DIN875 grade 00 (part no. **4794-025**)
  - 90° tool maker square 1.6x1.1" DIN875 grade 00 (part no. **4794-040**)
  - 90° beveled edge square 3.0x2.0" DIN875 grade 00 (part no. **4790-075**)
  - straight edge 3.9" DIN874 (part no. **4700-100**)
  - scriber
- Made of hardened stainless steel



4702-1

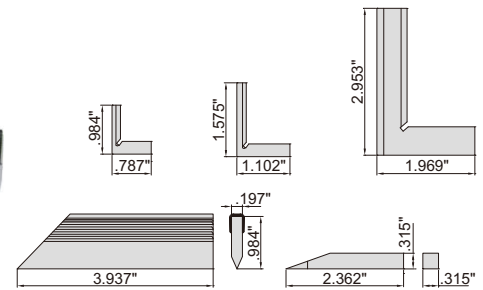

Part No.
4702-1

### GRANITE STRAIGHT EDGES

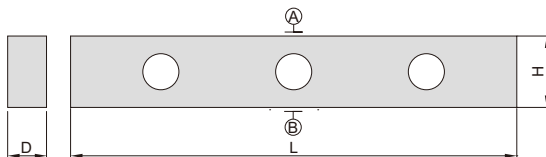

4147-500A

Part No.	Length (L)	Flatness of A and B	Parallelism between A and B	D	H
4147-500A	20"	83µin	126µin	1.969"	3.150"
4147-1000A	40"	118µin	177µin	2.362"	4.724"

### MAGNALIUM STRAIGHT EDGES

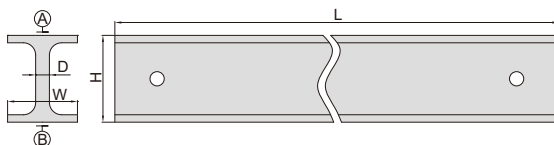

- Made of magnalium, light weight, non-deform, no rusty



4180-500

Part No.	Length (L)	Flatness of A and B	Parallelism between A and B	H	W	D
4180-500	20"	118µin	157µin	2.362"	1.181"	.197"
4180-1000	40"	197µin	315µin	2.362"	1.181"	.197"
4180-1500	60"	591µin	866µin	3.937"	1.575"	.197"
4180-2000	80"	709µin	1063µin	3.937"	1.575"	.315"



## PRECISION STRAIGHT EDGES



7117-300

- Check flatness and for marking
- Made of tool steel

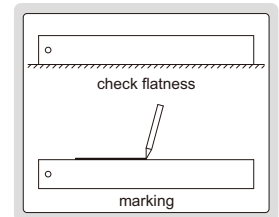
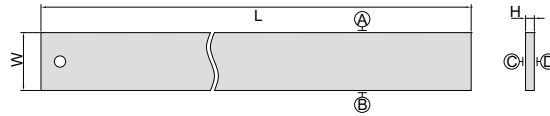

Part No.	Range (L)	Flatness of A and B	Flatness of C and D	W	H
7117-300	12"	.20mil	1.97mil	1.614"	.248"
7117-600	24"	.24mil	2.36mil	2.008"	.311"
7117-900	36"	.28mil	2.36mil	2.520"	.374"

## PRECISION STRAIGHT EDGES WITH BEVELED EDGE



7118-300

- Check flatness and for marking
- Made of tool steel

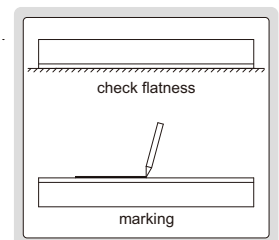
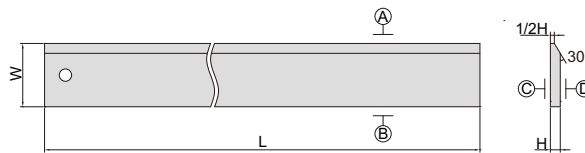

Part No.	Range (L)	Flatness of A and B	Flatness of C and D	W	H
7118-300	12"	.20mil	1.97mil	1.614"	.248"
7118-600	24"	.24mil	2.36mil	2.008"	.311"
7118-900	36"	.28mil	2.36mil	2.520"	.374"

## CENTER GAGES

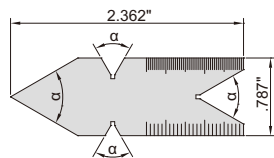

4810-602

- To check and set screw cutting tools, and check the angle and pitch of screw thread
- Angle accuracy:  $\pm 30\text{min}$ .
- Made of stainless steel

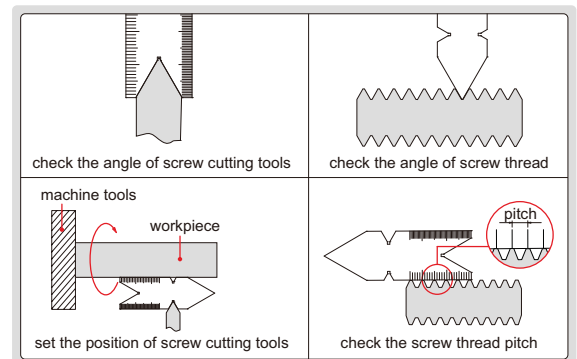

Part No.	Thread type	Angle ( $\alpha$ )	Graduation
4810-602	UNIFIED 60°	60°	14ths and 20ths on front side, 24ths and 32ths on back side
4810-601	METRIC 60°	60°	0.5mm and 1mm
4810-55	WHITWORTH 55°	55°	14ths and 20ths on front side, 24ths and 32ths on back side

## THREAD GAGES

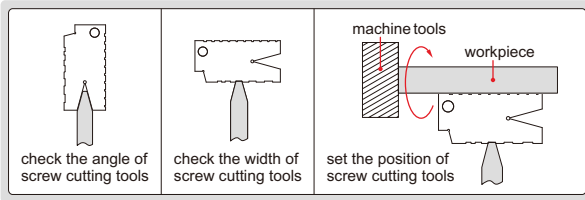

4812-E

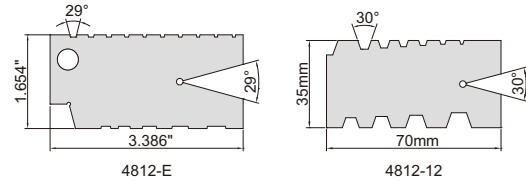

- To check and set screw cutting tools
- Angle accuracy:  $\pm 10\text{min}$ .
- Made of medium carbon steel

Part No.	Range	Thread type	Pitch
4812-E	1-10TPI	ACME 29°	1, 1-1/3, 1-1/2, 1-3/4, 2, 2-1/2, 3, 4, 5, 6, 7, 8, 9, 10TPI
4812-12	2-12mm	Tr 30°	2, 3, 4, 5, 6, 7, 8, 9, 10, 12mm

**ATTENTION:**  
LOW ACCURACY

## PITCH GAGES

- Check the pitch of screw thread
- Accuracy:  $\pm .0028''$
- Made of medium carbon steel



4820-122

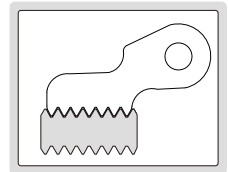

### Unified 60° screw

Part No.	Range	Pitch of leaves included	Quantity of leaves
4820-230	4-42TPI	4, 4-1/2, 5, 5-1/2, 6, 7, 8, 9, 10, 11, 11-1/2, 12, 13, 14, 15, 16, 18, 20, 22, 24, 26, 27, 28, 30, 32, 34, 36, 38, 40, 42TPI	30

### Metric 60° screw

Part No.	Range	Pitch of leaves included	Quantity of leaves
4820-122	0.4-7.0mm	0.4, 0.5, 0.6, 0.7, 0.75, 0.8, 0.9, 1, 1.25, 1.5, 1.75, 2, 2.5, 3, 3.5, 4, 4.5, 5, 5.5, 6, 6.5, 7mm	22
4820-124	0.25-7.0mm	0.25, 0.3, 0.35, 0.4, 0.5, 0.7, 0.75, 0.8, 0.9, 1, 1.25, 1.5, 1.75, 2, 2.5, 3, 3.5, 4, 4.5, 5, 5.5, 6, 6.5, 7mm	24

### Whitworth 55° screw

Part No.	Range	Pitch of leaves included	Quantity of leaves
4820-330	4-42TPI	4, 4-1/2, 5, 5-1/2, 6, 7, 8, 9, 10, 11, 12, 13, 14, 15, 16, 18, 19, 20, 22, 24, 26, 27, 28, 30, 32, 34, 36, 38, 40, 42TPI	30
4820-328	4-62TPI	4, 4-1/2, 5, 6, 7, 8, 9, 10, 11, 12, 13, 14, 16, 18, 19, 20, 22, 24, 25, 26, 28, 30, 32, 36, 40, 48, 60, 62TPI	28

## PITCH GAGES

- Check the pitch of screw thread
- Accuracy:  $\pm .0028''$
- Made of medium carbon steel



4824-12

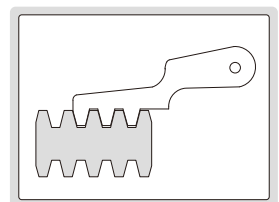

Part No.	Range	Thread type	Pitch of leaves included	Quantity of leaves
4824-16	1-12TPI	ACME 29°	1, 1-1/3, 1-1/2, 1-3/4, 2, 2-1/2, 3, 3-1/2, 4, 5, 6, 7, 8, 9, 10, 12TPI	16
4824-12	2-20mm	Tr30°	2, 3, 4, 5, 6, 7, 8, 9, 10, 12, 16, 20mm	12

## GEAR TOOTH PITCH GAGES

- Check the diametrical pitch of gear tooth
- Accuracy:  $\pm 0.002$ "
- Made of hardened stainless steel



4860-180

Part No.	Range (DP)	Pressure angle	Quantity of leaves
4860-15	2-5	14.5°	7
4860-25	2-5	20°	7
4860-180	6-80	14.5°	14
4860-280	6-80	20°	14

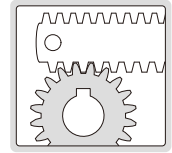
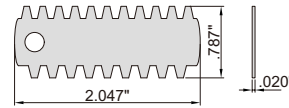

## ANGLE GAGE

- To check complementary angles
- Made of stainless steel



4806-20

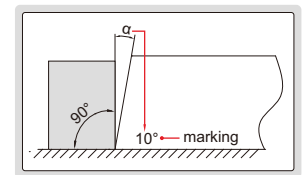

Part No.	Range	Angle of leaves included	Quantity of leaves	Accuracy
4806-20	1°-45°	1°, 2°, 3°, 4°, 5°, 6°, 7°, 8°, 9°, 10°, 12°, 14°, 16°, 18°, 20°, 25°, 30°, 35°, 40°, 45°	20	$\pm 30'$

## ANGLE GAGE SET



4807

- Each blade checks primary, 1/2 primary and complementary angles
- Made of medium carbon steel

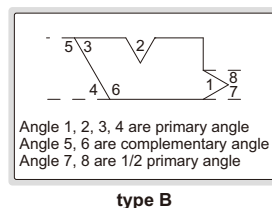
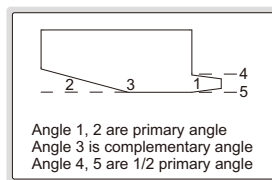

Primary angle	1/2 primary angle	Complementary angle	Type
5°	2°30'	175°	A
10°	5°	170°	A
15°	7°30'	165°	A
20°	10°	160°	B
25°	12°30'	155°	B
30°	15°	150°	B
35°	17°30'	145°	B
40°	20°	140°	B
45°	22°30'	135°	B
50°	25°	130°	B
55°	27°30'	125°	B
60°	30°	120°	B
65°	32°30'	115°	B
70°	35°	110°	B
75°	37°30'	105°	B
80°	40°	100°	B
85°	42°30'	95°	B
90°	45°	90°	B

Part No.	Quantity of leaves	Accuracy
4807	18	$\pm 10'$

**ATTENTION:  
LOW ACCURACY**



4801-15E

**RADIUS GAGES**

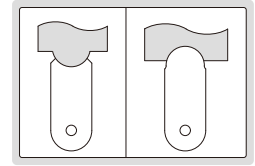

- Made of medium carbon steel

Part No.	Range	Radius of leaves included	Quantity of leaves (internal+external)	Accuracy
4801-15E	1/32"-1/4"	1/32", 3/64", 1/16", 5/64", 3/32", 7/64", 1/8", 9/64", 5/32", 11/64", 3/16", 13/64", 7/32", 15/64", 1/4"	15+15	±.0012"
4801-16E	17/64"-1/2"	17/64", 9/32", 19/64", 5/16", 21/64", 11/32", 23/64", 3/8", 25/64", 13/32", 27/64", 7/16", 29/64", 15/32", 31/64", 1/2"	16+16	±.0014"
4801-16E1	17/32"-1"	17/32", 9/16", 19/32", 5/8", 21/32", 11/16", 23/32", 3/4", 25/32", 13/16", 27/32", 7/8", 29/32", 15/16", 31/32", 1"	16+16	±.0017"

**ATTENTION:  
LOW ACCURACY**

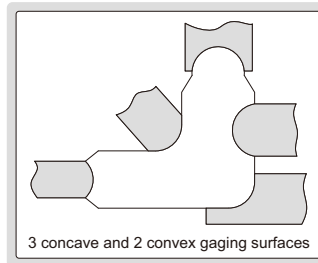

**RADIUS GAGE SETS**

- Each piece has 3 concave and 2 convex gauging surfaces
- Made of medium carbon steel



4804-26

Part No.	Range	Radius of leaves included	Quantity of leaves	Accuracy	Handle
4804-25E	1/64"~1/2"	1/64", 1/32", 3/64", 1/16", 5/64", 3/32", 7/64", 1/8", 9/64", 5/32", 11/64", 3/16", 13/64", 7/32", 15/64", 1/4", 17/64", 9/32", 5/16", 11/32", 3/8", 13/32", 7/16", 15/32", 1/2"	25	±.002"	with
4804-26E	.010"~.5"	.010", .015", .020", .025", .030", .040", .050", .060", .070", .080", .090", .100", .12", .14", .16", .18", .20", .22", .24", .26", .28", .30", .35", .40", .45", .50"	26	±.002"	with
4804-8E	9/16"~1"	9/16", 5/8", 11/16", 3/4", 13/16", 7/8", 15/16", 1"	8	±.0025"	without
4804-8E1	1-1/16"~1-1/2"	1-1/16", 1-1/8", 1-3/16", 1-1/4", 1-5/16", 1-3/8", 1-7/16", 1-1/2"	8	±.003"	without
4804-26	0.5~13mm	0.5, 1, 1.5, 2, 2.5, 3, 3.5, 4, 4.5, 5, 5.5, 6, 6.5, 7, 7.5, 8, 8.5, 9, 9.5, 10, 10.5, 11, 11.5, 12, 12.5, 13mm	26	±0.05mm	with

**CHAMFER GAGE**

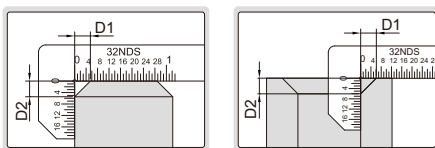

4844-1E

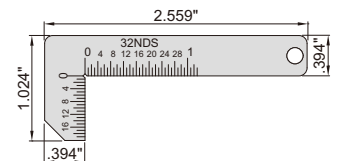

- To measure internal and external chamfers
- Made of stainless steel

Part No.	Graduation	Accuracy
4844-1E	1/32"	±.01"



## ELECTRONIC CHAMFER GAGES

- Measure 30°/45°/60° chamfer dimension
- Resolution .0005"/0.01mm
- Buttons: on/off, zero, inch/mm
- Automatic power off, move the digital unit to turn on power
- Battery CR2032, data output
- Made of stainless steel
- Optional accessory: data output cable (part no. 7306-20, 7302-SPC5A/SPC5B, 7305-SPC2A, 7305-A01/A02)

Part No.	Range	Accuracy	Chamfer (α)
1180-6	0-.39"/0-10mm	±.0025"	45°
1180-63	0-.39"/0-10mm	±.0025"	30°
1180-66	0-.39"/0-10mm	±.0025"	60°



1180-6

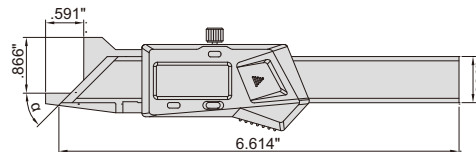

DATA OUTPUT

measure chamfer dimension

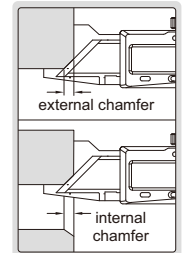

## CHAMFER GAGE

- Measure 45° chamfer dimension
- Graduation .001"
- Made of stainless steel
- Satin chrome plated reading surface

Part No.	Range	Accuracy
1267-02	0-.2"	±.003"



1267-02

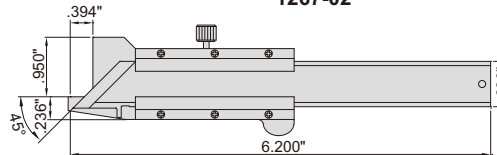

measure 45° chamfer dimension

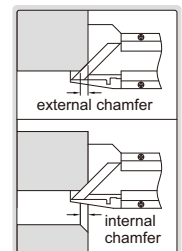

11

## ELECTRONIC CHAMFER HEIGHT GAGE

**INSIZE PLUS**  
MADE IN GERMANY

- Measure outside or inside chamfer height
- Suitable for diameter of bores ≥.236", chamfer angle α ≥30°
- Resolution .0005"/0.01mm
- Setting gage is included

principle of measurement

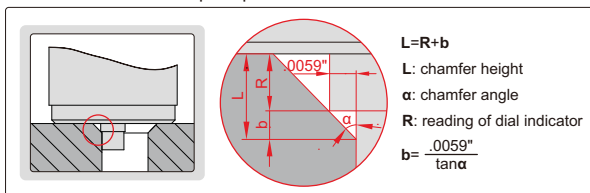

2944-1

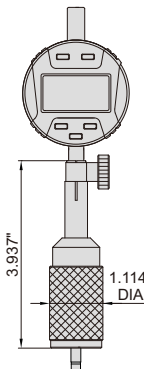

setting gage (included)



Part No.	Range (L)	Accuracy
2944-1	.008-.197"/0.2-5mm	±.0008"

## FEELER GAGE



4608-31

- .010" is made of brass, others are made of hardened alloy steel
- Each blade is marked with inch/metric size

Part No.	Range	Quantity of Leaves
4608-31	.0015"~.035"	32

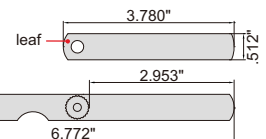

Thickness of leaves included	Accuracy
.010" (brass)	±.00039"
.0015", .002"	±.0002"
.0025", .003", .004", .005", .006", .007"	±.00028"
.008", .009"	±.00035"
.010", .011"	±.00039"
.012", .013"	±.00047"
.014", .015"	±.00051"

Thickness of leaves included	Accuracy
.016", .017"	±.00055"
.018", .019"	±.00059"
.020", .021"	±.00067"
.022", .023"	±.00071"
.024", .025", .026"	±.00075"
.028"	±.00091"
.030"	±.00094"
.032", .035"	±.00102"

DATA OUTPUT

ATTENTION: ACTUAL SLOT WIDTH IS 1/10 OF THE READING

## ELECTRONIC TAPER GAGE

- Measuring opening, slot width
- Resolution .0005"/0.01mm
- Buttons: on/off, zero, inch/mm
- Automatic power off, move the digital unit to turn on power
- Battery CR2032, data output
- Made of stainless steel
- Optional accessory: data output cable (part no. 7306-20, 7302-SPC5A/SPC5B, 7305-SPC2A, 7305-A01/A02)

Part No.	Range	Accuracy
1160-10	.008-.394"/0.2-10mm	±.001"

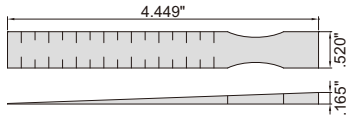
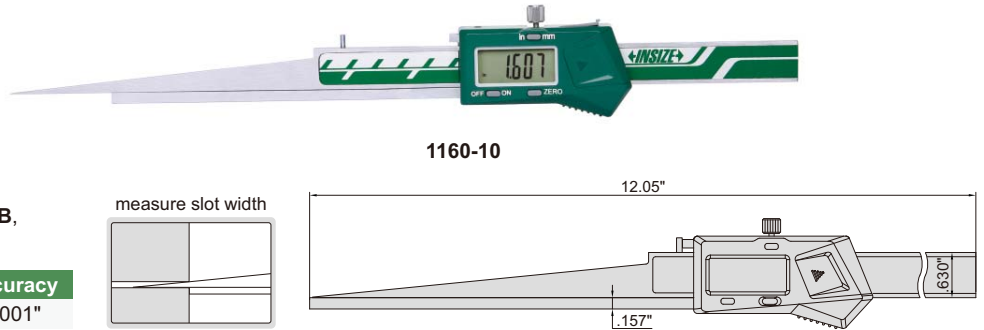

- For quick measurement of slot width
- Stain chrome plated reading surface
- Made of stainless steel

Part No.	Range	Graduation	Accuracy
4630-1E	.01-.15"	.001"	±.003"

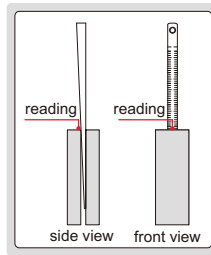

4630-1E

## TAPER GAGE

## TAPER GAGES

- Measure opening, slot width, hole diameter, etc.
- Diameter correction table on the back (except 4833-4E)
- Made of stainless steel

measure diameter of hole

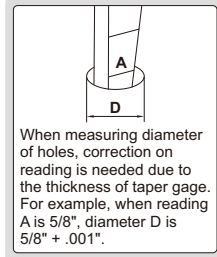

measure slot width

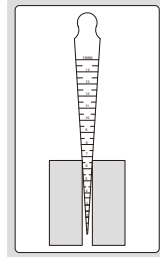

Part No.	Range	Graduation	Accuracy	L	W
4833-1E	1/32~5/8"	1/64"	±.004"	5.748"	.669"
4833-2E	5/8~1-3/16"	1/64"	±.004"	6.260"	1.197"
4833-3E	1-3/16~1-3/4"	1/64"	±.004"	6.535"	1.787"
4833-4E	1-3/4~2-3/8"	1/64"	±.004"	6.693"	2.382"

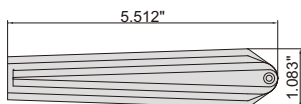
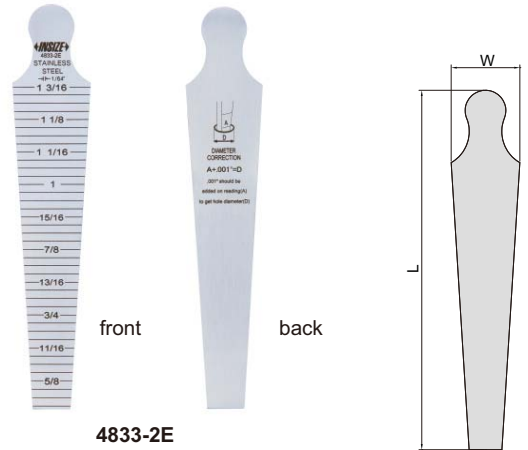

- Graduation: 1/64"
- Include 4 pcs (1/16~5/16", 21/64~9/16", 37/64~13/16", 53/64~1-1/16")
- Measure opening, slot width, hole diameter, etc.
- Diameter correction table on the back
- Made of stainless steel

Part No.	Range	Accuracy
4837-1E	1/16~1-1/16"	±.004"

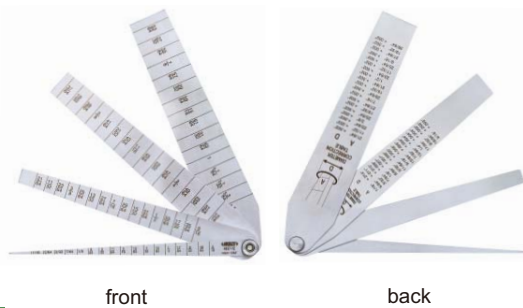

## TAPER GAGE SET

measure diameter of hole

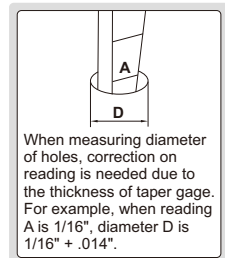

measure slot width

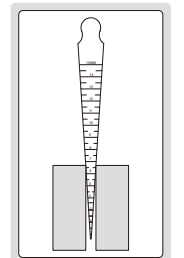

## TAPER BORE GAGES

- Quick measurement of bore diameter
- Hardened steel, HRC50-58
- Satin chrome plated surface
- Aluminium oxidized handle

Part No.	Range	Graduation	Accuracy	L	d1	d2
4852-E15	.6-1.2"	.005"	±.0025"	6.496"	1.220" DIA	.579" DIA
4852-E30	1.2-1.8"	.005"	±.0025"	6.496"	1.811" DIA	1.165" DIA



4852-E15

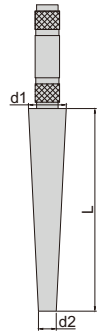

## WELDING GAGE

- Made of stainless steel
- Stain chrome plated reading surface

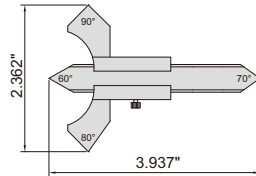

4830-E

Part No.	Measurement	Range	Graduation	Accuracy
4830-E	crown height	0-5/16"	1/128"	±.0039"
	fillet weld throat size	0-9/16"	1/128"	±.0118"
	angle	60°, 70°, 80°, 90°	—	±1°

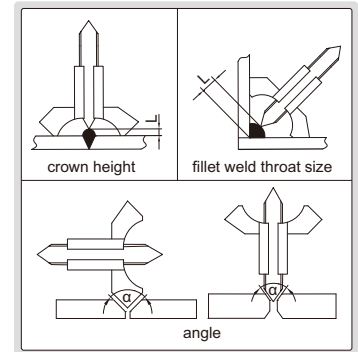

11

## ELECTRONIC WELDING GAGE

**ATTENTION:**  
NO DATA OUTPUT

- Buttons: zero, inch/mm, on/off
- Battery LR44
- Made of stainless steel

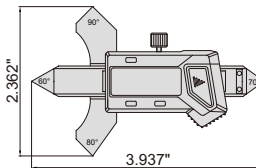

4831-20A

Part No.	Measurement	Range	Resolution	Accuracy
4831-20A	crown height	0-.4"/0-7mm	.0005"/0.01mm	±.0012"
	fillet weld throat size	0-.8"/0-20mm	.0005"/0.01mm	±.0039"
	angle	60°, 70°, 80°, 90°	—	±1°

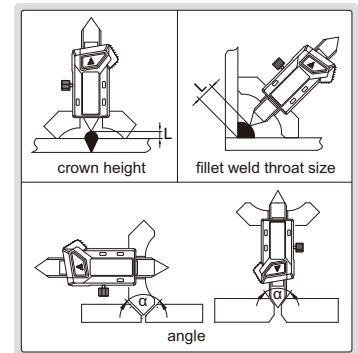

## FILLET WELDING GAGES

- Measure concave and convex weld sizes
- 7 blades are included
- Made of stainless steel



4836-2



4836-1

Part No.	Size	Accuracy
4836-2	1/8" (3.2mm), 3/16" (4.8mm), 1/4" (6.4mm), 5/16" (7.9mm), 3/8" (9.5mm), 7/16" (11.1mm), 1/2" (12.7mm), 5/8" (15.9mm), 3/4" (19.1mm), 7/8" (22.2mm), 1" (25.4mm)	±.02" (0.5mm)
4836-1	3, 4, 5, 6, 8, 9, 10, 11, 12, 14, 16, 19, 22, 25mm	±0.5mm

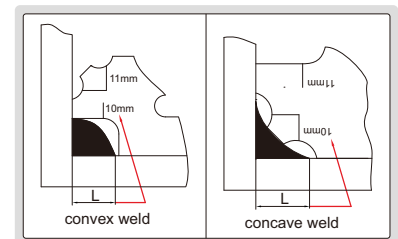
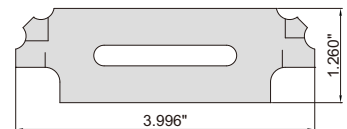

## WELDING GAGE

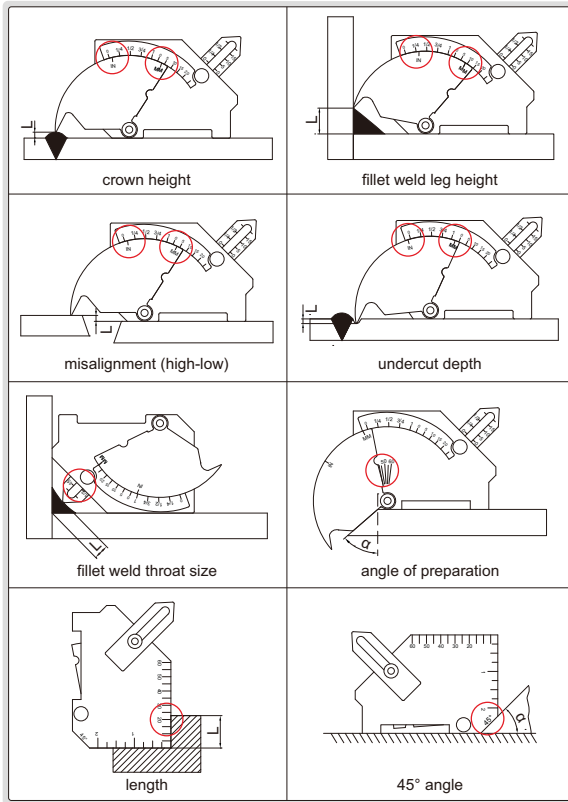

front

4835-1

back

- Adjustable scale to compensate pointer wear
- Made of stainless steel

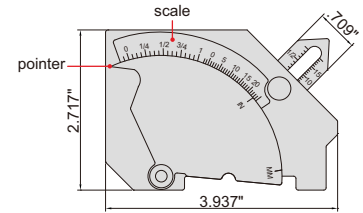

Part No.	Measurement	Range	Graduation	Accuracy
4835-1	crown height	0-1" (0-25mm)	1/16" (1mm)	±.02"
	fillet weld leg height	0-1" (0-25mm)	1/16" (1mm)	±.02"
	misalignment (high-low)	0-1" (0-25mm)	1/16" (1mm)	±.02"
	undercut depth	0-1/8" (0-2mm)	1/16" (1mm)	±.02"
	fillet weld throat size	0-3/4" (0-20mm)	1/16" (1mm)	±.02"
	angle of preparation	0-60°	5°	±1°
	length	0-2" (0-60mm)	1/16" (1mm)	±.02"
	45° angle	—	—	±1°

## PIPE WELDING GAGE

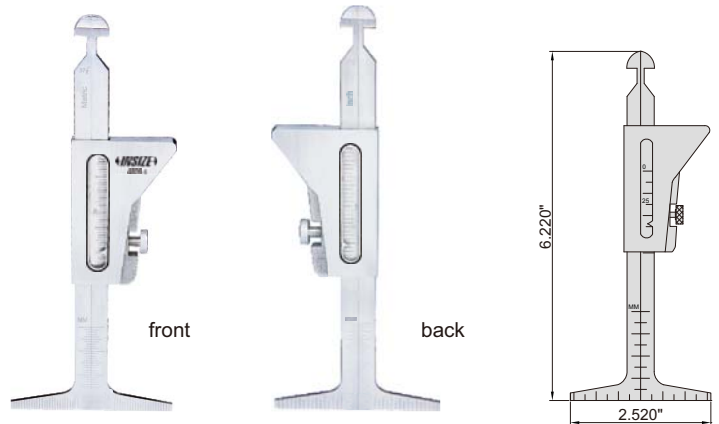
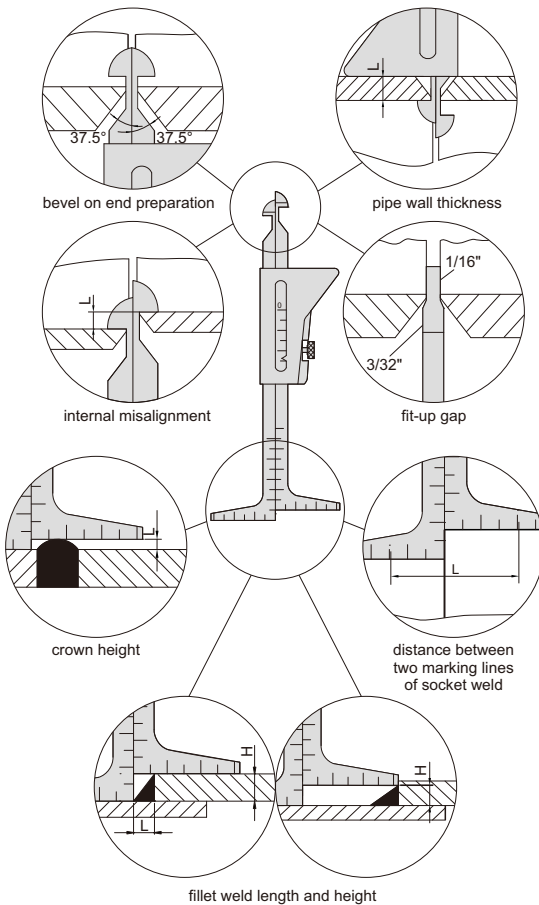

front

back

4839-1

- Made of stainless steel

Part No.	Measurement	Range	Graduation	Accuracy
4839-1	bevel on end preparation	37.5°	—	±1°
	pipe wall thickness	0~1-3/4" (0-45mm)	1/16" (1mm)	±.02"
	internal misalignment	0~1-3/8" (0-35mm)	1/32" (1mm)	±.02"
	fit-up gap	1/16", 3/32"	—	±.004"
	crown height	0~1-3/8" (0-35mm)	1/32" (1mm)	±.02"
	distance between two marking lines of socket weld	0~2-3/8" (0-60mm)	1/16" (1mm)	±.02"
	fillet weld length	0~1-1/4" (0-30mm)	1/16" (1mm)	±.02"
	fillet weld height	0~1-3/8" (0-35mm)	1/32" (1mm)	±.02"

## FILLET WELDING GAGE

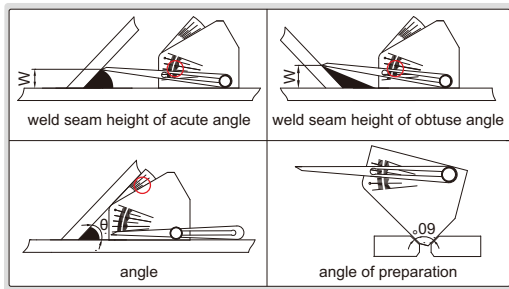

Part No.	Measurement	Range	Graduation	Accuracy
4846-1	weld seam height W	0-2"/0-50mm	.050"/2mm	±.025"
	angle $\theta$	30°-90°	2.5°	±1°
	60° angle	—	—	±0.5°



4846-1

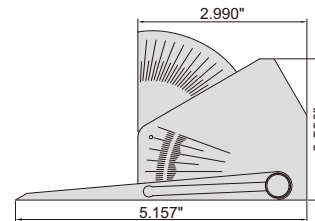

- Calculating card is included
- Made of stainless steel

calculating card (included)

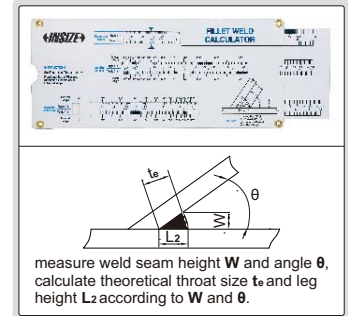

## DRILL POINT GAGE

- For twist drills with 118° angle, to check if the center of tip is concentric with the drill body
- Made of stainless steel

Part No.	Accuracy	
	Angle	Length
4843-1E	±0.5°	±.02"



4843-1E

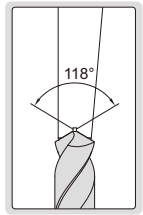
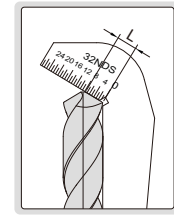
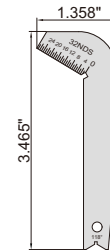

## DRILL ANGLE GAGE

- Check drills with angle 60°, 70°, 90°, 118°, 125°, 135°, 150° or 160°
- Made of stainless steel

Part No.	Accuracy
4842-1	±0.5°



4842-1

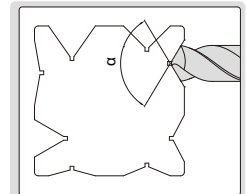
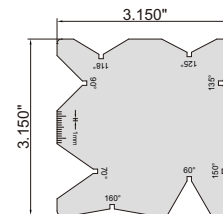

## AMERICAN STANDARD WIRE GAGE

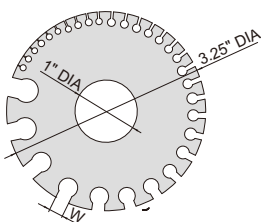

4808

Part No.	Range
4808	0-36 (.3249-.0050")

- For gaging non-ferrous wire and metals such as copper, brass and aluminum
- Hardened and satin chrome finish

No.	W	No.	W	No.	W
0	.3249"	13	.0720"	26	.0159"
1	.2893"	14	.0641"	27	.0142"
2	.2576"	15	.0571"	28	.0126"
3	.2294"	16	.0508"	29	.0113"
4	.2043"	17	.0453"	30	.0100"
5	.1819"	18	.0403"	31	.0089"
6	.1620"	19	.0359"	32	.0080"
7	.1443"	20	.0320"	33	.0071"
8	.1285"	21	.0285"	34	.0063"
9	.1144"	22	.0253"	35	.0056"
10	.1019"	23	.0226"	36	.0050"
11	.0907"	24	.0201"		
12	.0808"	25	.0179"		



## U.S. STANDARD SHEET METAL GAGE

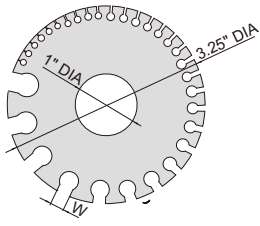

4809

- For gaging sheet metal, plate iron and steel
- Hardened and satin chrome finish

Part No.	Range
4809	0-36 (.3125-.0070")

No.	W	No.	W	No.	W
0	.3125"	13	.0938"	26	.0188"
1	.2813"	14	.0781"	27	.0172"
2	.2656"	15	.0703"	28	.0156"
3	.2500"	16	.0625"	29	.0141"
4	.2344"	17	.0563"	30	.0125"
5	.2188"	18	.0500"	31	.0109"
6	.2031"	19	.0438"	32	.0102"
7	.1875"	20	.0375"	33	.0094"
8	.1719"	21	.0344"	34	.0086"
9	.1563"	22	.0313"	35	.0078"
10	.1406"	23	.0281"	36	.0070"
11	.1250"	24	.0250"		
12	.1094"	25	.0219"		

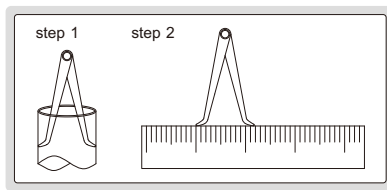

- Made of carbon steel

Part No.	Size (L)	Range (W)	h
7240-150	6"	.669-5.905"	.079"
7240-200	8"	.669-7.874"	.118"
7240-300	12"	.709-11.811"	.118"



7240-150

## INSIDE CALIPERS

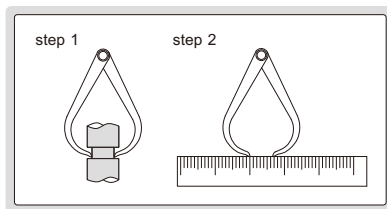
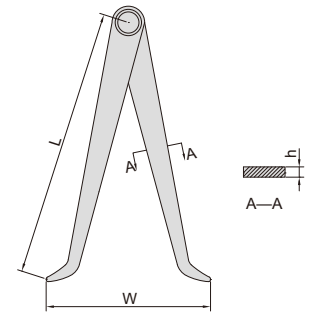

- Made of carbon steel

Part No.	Size (L)	Range (W)	h
7241-150	6"	.669-5.905"	.079"
7241-200	8"	.669-7.874"	.118"
7241-300	12"	.709-11.811"	.118"



7241-150

## OUTSIDE CALIPERS

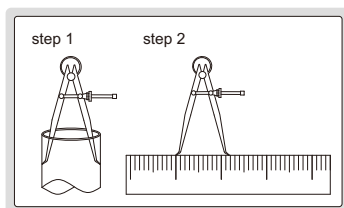
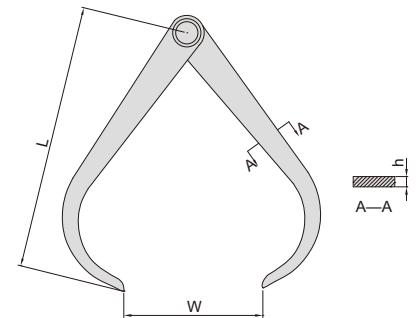

Part No.	Size (L)	Range (W)
7261-150	6"	.79-6.69"
7261-200	8"	.87-8.66"
7261-250	10"	1.18-10.63"
7261-300	12"	1.18-12.60"



tips

- Made of carbon steel



7261-150

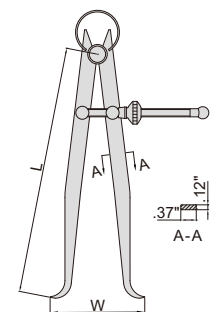

## OUTSIDE SPRING CALIPERS

- Made of carbon steel

Part No.	Size (L)	Range (W)
7262-150	6"	0-5.51"
7262-200	8"	0-8.27"
7262-250	10"	0-10.63"
7262-300	12"	0-12.60"



7262-150

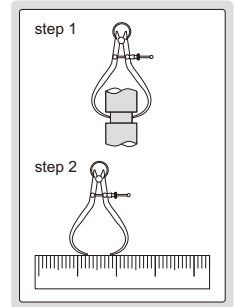
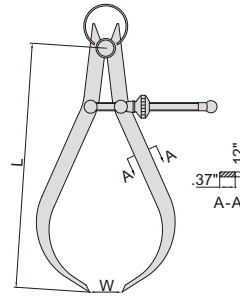

## SPRING DIVIDERS

- Made of carbon steel
- Hardened points

Part No.	Size (L)	Range (W)
7260-150	6"	0-5.91"
7260-200	8"	0-8.27"
7260-250	10"	0-10.24"
7260-300	12"	0-12.60"



7260-150

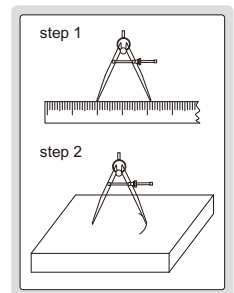
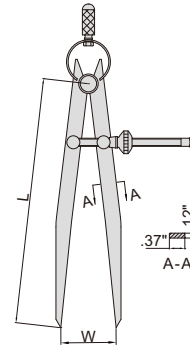

## DIVIDERS

- Made of carbon steel
- Hardened points

Part No.	Size (L)	Range (W)	a	b
7247-150	6"	0-5.51"	.33"	.28"
7247-200	8"	0-7.48"	.39"	.28"
7247-300	12"	0-11.42"	.47"	.28"



7247-150

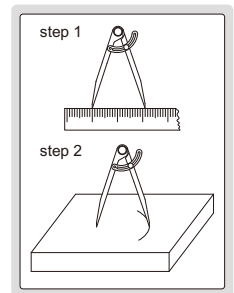
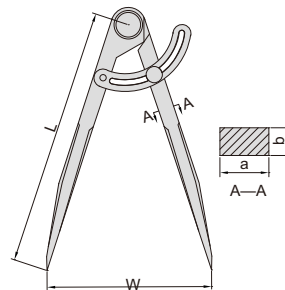

## POCKET RULE WITH SLIDING CLIP

- With sliding clip, clip also can be used as depth gage base
- Inch/metric conversion table on the back
- Made of stainless steel

Part No.	Range	Graduation	Accuracy
7119-150	6"/150mm	1/64", 1mm	±.006"



7119-150

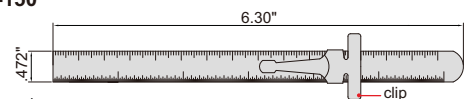

## RIGID RULE

- Rigid rules
- With groove on the back, suitable for combination square set (2278 series)
- Satin chrome plated



7113-300A



groove on the back

Part No.	Range	Graduation		Accuracy	L
		front	back		
7113-300A	12"/300mm	1/32" and 0.5mm	1/64" and 1mm	±.006"	12"





## RIGID RULES

- 4R graduation
- Made of stainless steel
- Non-glare surface

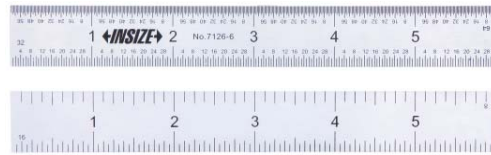

front

back

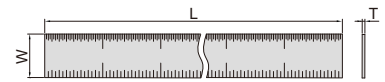

7126-6

Part No.	Range (L)	Graduation	Accuracy	W	T
7126-6	6"	1/64" and 1/32" on front face, 1/16" and 1/8" on back face	±.003"	.748"	.039"
7126-12	12"	1/64" and 1/32" on front face, 1/16" and 1/8" on back face	±.004"	.984"	.039"
7126-24	24"	1/64" and 1/32" on front face, 1/16" and 1/8" on back face	±.006"	1.102"	.047"

## STEEL RULES

**ATTENTION:  
BASIC MODEL**



7110-300

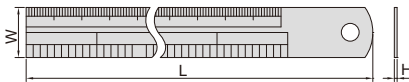

- Graduation: 1/64", 1/32", 1/16", 0.5mm, 1mm
- Semi-flexible rules
- Made of stainless steel
- Non-glare surface

Part No.	Range	Accuracy	L	W	H	Remark
7110-150	6"/150mm	±.006"	6.693"	.709"	.039"	graduation on front and back
7110-200	8"/200mm	±.006"	8.661"	.709"	.039"	graduation on front and back
7110-300	12"/300mm	±.006"	12.992"	.984"	.039"	graduation on front and back
7110-3001	12"/300mm	±.006"	12.795"	1.181"	.039"	graduation on front and back
7110-500	20"/500mm	±.006"	20.866"	1.181"	.047"	graduation on front and back
7110-600	24"/600mm	±.008"	24.803"	1.181"	.047"	graduation on front and back
7110-1000	40"/1000mm	±.008"	40.945"	1.260"	.059"	graduation on front and back
7110-1200	48"/1200mm	±.009"	48.819"	1.378"	.071"	graduation on front
7110-1500	60"/1500mm	±.010"	61.024"	1.496"	.071"	graduation on front
7110-2000	80"/2000mm	±.012"	81.299"	1.575"	.079"	graduation on front

11

## COMBINATION SQUARE SETS

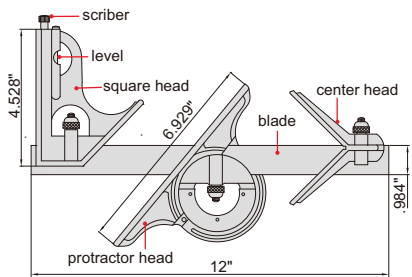

- Center head (made of cast iron):  
To locate center of cylinder with diameter (d): 1.181" DIA-3.937" DIA  
Accuracy: ±.006"
- Protractor head (made of cast iron):  
To set the blade at desired angle to an edge of a workpiece, and can be used to measure angles  
Range: 0-180°, accuracy: ±7min.
- Square head (made of cast iron):  
To set the blade at 90° or 45° to an edge of a workpiece  
Accuracy: ±8min for 90° square,  
±10min for 45° square
- Optional accessory: rigid rule (part no. 7113)

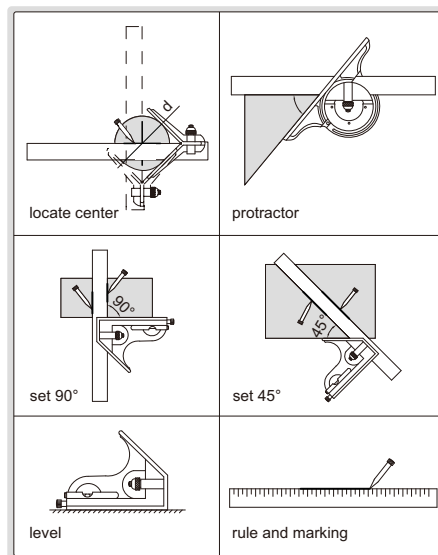

2278-2



2278-3



2278-180

Part No.	Remark	Blade range	Blade graduation
2278-2	2-piece set	12"/300mm	1/32" and 0.5mm on front face, 1/64" and 1mm on back face
2278-2E	2-piece set	12"	1/8" and 1/16" on front face, 1/32" and 1/64" on back face
2278-3	3-piece set	12"/300mm	1/32" and 0.5mm on front face, 1/64" and 1mm on back face
2278-3E	3-piece set	12"	1/8" and 1/16" on front face, 1/32" and 1/64" on back face
2278-180	4-piece set	12"/300mm	1/32" and 0.5mm on front face, 1/64" and 1mm on back face
2278-180E	4-piece set	12"	1/8" and 1/16" on front face, 1/32" and 1/64" on back face

## DOUBLE SQUARE

- Accuracy:  $\pm 2\text{min}$  for  $90^\circ$  square
- Hardened and chrome plated blade

Part No.	Blade length	Graduation
2277-2	6"	1/8", 1/16", 1/32", 1/64"

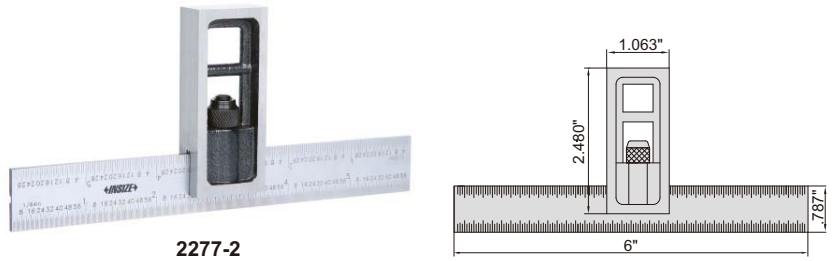

2277-2

## SCRIBING CALIPER

- Made of stainless steel
- Satin chrome plated reading surface
- Carbide scriber tip
- Optional accessory: carbide scriber tip (part no. SP-SCRIBER-7202)

the position of scriber tip can be adjusted



7202-200A

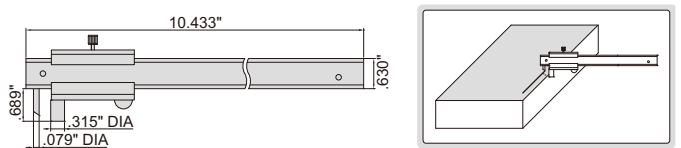

Part No.	Range	Graduation	Accuracy
7202-200A	0-8"/0-200mm	1/128", 0.1mm	$\pm .004"$

## ELECTRONIC SCRIBING CALIPERS

- The carbide-tipped jaws facilitate scribing on workpieces
- Resolution .0005"/0.01mm
- Buttons: on/off, zero, inch/mm
- Automatic power off, move the digital unit to turn on power
- Battery CR2032, data output
- Made of stainless steel
- Optional accessory: data output cable (part no. 7306-20, 7302-SPC5A/SPC5B, 7305-SPC2A, 7305-A01/A02)

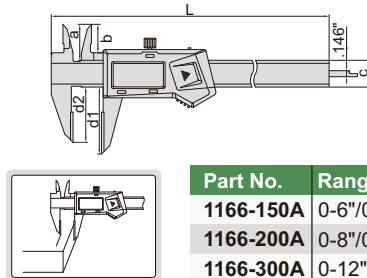

DATA OUTPUT

1166-150A

Part No.	Range	Accuracy	L	a	b	c	d1	d2
1166-150A	0-6"/0-150mm	$\pm .0012"$	9.291"	.827"	.650"	.630"	1.575"	1.299"
1166-200A	0-8"/0-200mm	$\pm .0012"$	11.260"	.945"	.768"	.630"	1.969"	1.693"
1166-300A	0-12"/0-300mm	$\pm .0016"$	15.748"	.984"	.807"	.669"	2.362"	2.087"

## HEIGHT SCRIBER

- Grooved bottom for cylinder
- Two pins to be set against the edge of surface plate

6990-300A

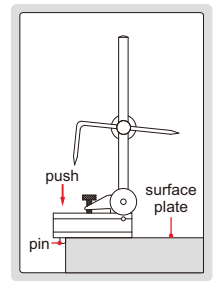
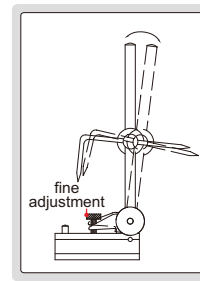
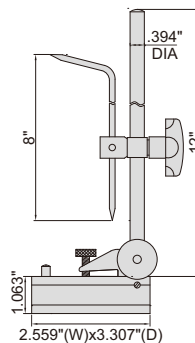

Part No.
6990-300A

## SCRIBERS

- Nickel plated

Part No.	Tip
7230	hardened tips
7231	hardened tip
7232	carbide tip



7230

7231

7232

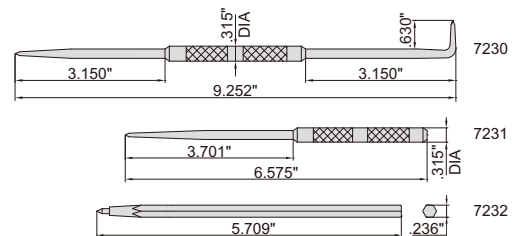

7230

7231

7232

## LONG DRIVE PIN PUNCH

- Made of tool steel, black oxide finish
- Hardened and tempered both ends
- Knurled finger grip for ease of use
- 5 pcs set
- 8" length, drive pin section 3-1/2" long



7253

Part No.	Point size (DIA)
7253	1/8", 3/16", 1/4", 5/16", 3/8"

## DRIVE PIN PUNCH

- Made of tool steel, black oxide finish
- Hardened and tempered both ends
- Knurled finger grip for ease of use
- 8 pcs set
- 4" length



7252

Part No.	Point size (DIA)
7252	1/16", 3/32", 1/8", 5/32", 3/16", 7/32", 1/4", 5/16"

## CENTER PUNCH

- Made of tool steel, black oxide finish
- Hardened and tempered both ends
- Knurled finger grip for ease of use
- 5 pcs set
- 4" length, 1/16" diameter



7251

Part No.	Point size (DIA)
7251	1/16", 5/64", 3/32", 9/64", 5/32"

## 2-PIECE MEASURING TOOL SET

- Includes:
  - 1) Electronic caliper, range 0-6"/0-150mm, resolution .0005"/0.01mm (part no. 1108-150)
  - 2) Electronic outside micrometer, range 0-1"/0-25mm, resolution .00005"/0.001mm (part no. 3109-25E)



5022-E

Part No.  
5022-E

## 2-PIECE MEASURING TOOL SET

- Includes:
  - 1) Dial test indicator, range .03", graduation .0005" (part no. 2380-35)
  - 2) Magnetic stand



5023-E

Part No.  
5023-E

11

12



## 2-PIECE MEASURING TOOL SET

- Includes:
  - 1) Dial indicator, range 1", graduation .001" (part no. 2307-1)
  - 2) Magnetic stand (part no. 6201-60)

**Part No.**  
5002-4E



5002-4E

## 3-PIECE MEASURING TOOL SET

- Includes:
  - 1) Dial caliper, range 0-6", graduation .001" (part no. 1311-6)
  - 2) Outside micrometer, range 0-1", graduation .0001" (part no. 3202-1)
  - 3) Steel rule, 6"/150mm (part no. 7110-150)

**Part No.**  
5003-1



5003-1

12

## 3-PIECE MEASURING TOOL SET

- Includes:
  - 1) Electronic caliper, range 0-6"/0-150mm, resolution .0005"/0.01mm (part no. 1108-150)
  - 2) Outside micrometer, range 0-1", graduation .0001" (part no. 3202-1)
  - 3) Steel rule, 6"/150mm (part no. 7110-150)

**Part No.**  
5003-1E



5003-1E

## 3-PIECE MEASURING TOOL SET

- Includes:
  - 1) Electronic indicator, range .5"/12.7mm, resolution .0005"/0.01mm (part no. 2112-10E)
  - 2) Flex arm
  - 3) Locking pliers, adjustable jaw opening from 0 to 1"



**Part No.**  
5031-E



5031-E

## 4-PIECE MEASURING TOOL SET

- Includes:
  - 1) Electronic caliper, range 0-6"/0-150mm, resolution .0005"/0.01mm (part no. **1108-150**)
  - 2) Outside micrometer, range 0-1", graduation .0001" (part no. **3202-1**)
  - 3) 90° beveled edge square, 3.937x2.756", grade 0 (part no. **4790-1000**)
  - 4) Steel rule, 6"/150mm (part no. **7110-150**)



5042-E

**Part No.**  
5042-E

## 5-PIECE MEASURING TOOL SET

- Includes:
  - 1) Electronic caliper, range 0-6"/0-150mm, resolution .0005"/0.01mm, (part no. **1108-150**)
  - 2) Outside micrometer, range 0-1", graduation .0001" (part no. **3203-1A**)
  - 3) Dial indicator, range 1", graduation .001" (part no. **2307-1**)
  - 4) Magnetic stand (part no. **6201-60**)
  - 5) Micrometer stand (part no. **6300**)



5051-E

**Part No.**  
5051-E

## 5-PIECE MEASURING TOOL SET

- Includes:
  - 1) Electronic caliper, range 0-6"/0-150mm, resolution .0005"/0.01mm (part no. **1108-150**)
  - 2) Electronic outside micrometer, range 0-1"/0-25mm, resolution .00005"/0.001mm (part no. **3109-25E**)
  - 3) Electronic indicator, range .5"/12.7mm, resolution .0005"/0.01mm (part no. **2112-10E**)
  - 4) Magnetic stand (part no. **6201-60**)
  - 5) Micrometer stand (part no. **6300**)



5052-E

**Part No.**  
5052-E

## 6-PIECE MEASURING TOOL SET

- Includes:
  - 1) Electronic caliper, range 0-6"/0-150mm resolution .0005"/0.01mm (part no. **1108-150**)
  - 2) Outside micrometer, range 0-1", graduation .0001" (part no. **3202-1**)
  - 3) 90° beveled edge square, 3.937x2.756", grade 00 (part no. **4790-0100**)
  - 4) Straight edge, 3.937" (part no. **4700-100**)
  - 5) Spring divider, 6"/150mm (part no. **7260-150**)
  - 6) Steel rule, 8"/200mm (part no. **7110-200**)



5062-E

**Part No.**  
5062-E

## 9-PIECE MEASURING TOOL SET

- Includes:
  - 1) Electronic caliper, range 0-6"/0-150mm, resolution .0005"/0.01mm (part no. **1108-150**)
  - 2) Outside micrometer, range 0-1", graduation .0001" (part no. **3202-1**)
  - 3) Protractor, range 0-180°, graduation 1° (part no. **4799-180**)
  - 4) Pitch gauge, range 4-42TPI, 30 pcs, unified 60° thread (part no. **4820-230**)
  - 5) Radius gauge, range 1/32"-1/4" (part no. **4801-15E**)
  - 6) Feeler gauge, range .0015-.035", 31 pcs (part no. **4608-31**)
  - 7) 90° beveled edge square, 3.937x2.756", grade 0 (part no. **4790-1000**)
  - 8) Scriber (part no. **7230**)
  - 9) Steel rule, 6"/150mm (part no. **7110-150**)

**Part No.**  
**5091-E**



5091-E

## 13-PIECE MEASURING TOOL SET

- Includes:
  - 1) Electronic caliper, range 0-6"/0-150mm, resolution .0005"/0.01mm, (part no. **1108-150**)
  - 2) Outside micrometer, range 0-1", graduation .0001" (part no. **3202-1**)
  - 3) Dial indicator, range 1", graduation .001" (part no. **2307-1**)
  - 4) Magnetic stand (part no. **6201-60**)
  - 5) Protractor, range 0-180°, graduation 1° (part no. **4799-180**)
  - 6) Pitch gauge, range 4-42TPI, 30 pcs, unified 60° thread (part no. **4820-230**)
  - 7) Radius gauge, range 1/32"-1/4" (part no. **4801-15E**)
  - 8) Feeler gauge, range .0015-.035", 31 pcs (part no. **4608-31**)
  - 9) 90° beveled edge square, 3.937x2.756", grade 0 (part no. **4790-1000**)
  - 10) Scriber (part no. **7230**)
  - 11) Steel rule, 6"/150mm (part no. **7110-150**)
  - 12) Depth base attachment (part no. **6140**)
  - 13) Zero setting bar for depth base attachment

**Part No.**  
**5013-E**



5013-E

## GRANITE SURFACE PLATES

ADDITIONAL CUSTOM SIZES UP TO 6.5' AVAILABLE ON REQUEST



- Made of granite, free from deterioration or dimensional change over time, minimal changes in dimension due to temperature changes
- Meet GGG-P-463C
- Optional accessory: stand for granite surface plate (part no. **6902**), jack for granite surface plate (part no. **6903**)

### Grade A

Part No.	Size (LxWxH)	Flatness	Weight (lb)	Max. load (lb)
<b>6900-A11 *</b>	12x18x3"	.12mil	32	110
<b>6900-A12 *</b>	18x24x3"	.13mil	64	143
<b>6900-A23 *</b>	24x36x4"	.15mil	170	440
<b>6900-A34 *</b>	36x48x6"	.18mil	510	1102

\* Supplied with manufacturer inspection certificate



6900-A11



## STANDS FOR GRANITE SURFACE PLATES

- For medium size granite surface plates
- 5 jacks are included
- Adjusting range of jacks: 1"
- One foot on the bottom is adjustable



6902-64A

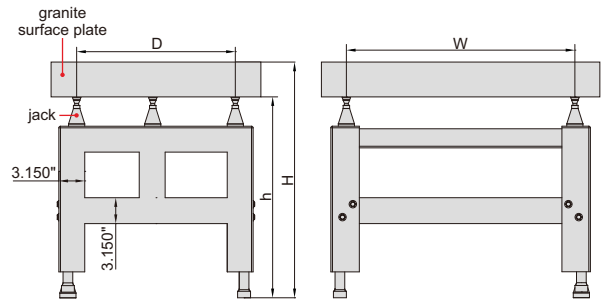

### Low stands

Part No.	For granite surface plate	W	D	H (with granite surface plate)	h (without granite surface plate)
6902-64A	12x18x3" (part no. 6900-A11)	13.858"	8.819"	30.512-31.496"	27.362-28.346"
6902-85A	18x24x3" (part no. 6900-A12)	17.638"	11.024"	30.512-31.496"	26.575-27.559"
6902-106A	24x36x4" (part no. 6900-A23)	22.047"	13.858"	29.724-30.709"	24.213-25.197"
6902-161A	36x48x6" (part no. 6900-A34)	35.276"	22.047"	29.724-30.709"	22.638-23.622"

### High stands

Part No.	For granite surface plate	W	D	H (with granite surface plate)	h (without granite surface plate)
6902-64H	12x18x3" (part no. 6900-A11)	13.858"	8.819"	39.370-40.354"	36.220-37.205"
6902-85H	18x24x3" (part no. 6900-A12)	17.638"	11.024"	39.370-40.354"	35.433-36.417"
6902-106H	24x36x4" (part no. 6900-A23)	22.047"	13.858"	39.370-40.354"	33.858-34.843"
6902-161H	36x48x6" (part no. 6900-A34)	35.276"	22.047"	39.370-40.354"	32.283-33.268"

## JACK SET FOR GRANITE SURFACE PLATES

- 5 jacks per set
- Adjustable height
- For large granite surface plates over 6.5ft



6903-B

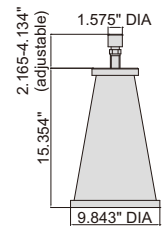

Part No.

6903-B

HARDENED SURFACES

HIGH PRECISION

STRONG MAGNETIC FORCE

## MAGNETIC RECTANGULAR BLOCKS

- For grinding, light milling, drilling and inspection of round and square jobs
- Hardened, high accuracy, strong magnetic force
- Working surfaces are hardened to HRC58-62
- Magnetic force on top, bottom and back sides
- Supplied in matched pair

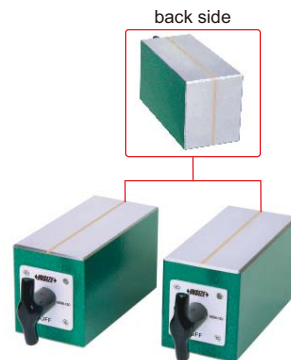

6898-150

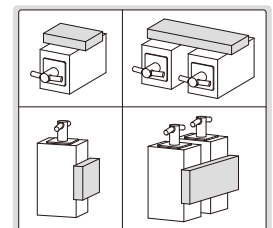
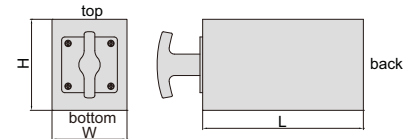

Part No.	Size (LxWxH)	Magnetic force	Parallelism of top to bottom side	Squareness of top and bottom to back side	Height difference of a matched pair
6898-100	3.9x2.8x2.8"	220lbf	197µin	197µin	197µin
6898-150	5.9x2.8x3.3"	275lbf	197µin	197µin	197µin



## V-BLOCK SETS

- Hold cylindrical workpieces for inspection and machining
- Two V-blocks per set
- Made of alloy steel
- Hardened to HRC60±2
- V groove on the top for large shafts
- V groove on the bottom for small shafts (except 6896-10)



6896-10

6896-11

Part No.	Size (LxWxH)	Range of shafts (d)	Parallelism of both V grooves to top and bottom sides	Squareness of both V grooves to front and back sides	Height difference of a matched pair
6896-10	1.0x.8x.8"	.12-.79" DIA	118µin	118µin	118µin
6896-11	2.0x1.6x1.6"	.20-1.18" DIA	197µin	197µin	197µin
6896-12	3.1x2.5x2.5"	.28-2.48" DIA	197µin	197µin	197µin
6896-13	3.9x3.1x3.1"	.28-3.15" DIA	197µin	197µin	197µin
6896-14	2.8x5.5x5.5"	.35-5.51" DIA	197µin	197µin	197µin

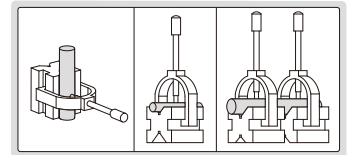

## V-BLOCK SET

SIDE LIE-DOWN USE IS POSSIBLE

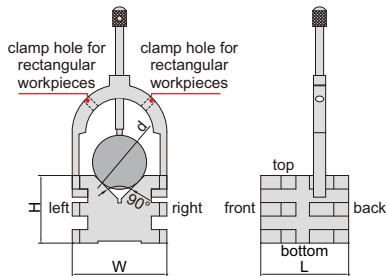

6802-1

- Hold cylindrical or rectangular workpieces for inspection and machining
- Two V-blocks per set
- Made of alloy steel
- Hardened to HRC60±2
- Applicable for cylinder with diameter (d) .20-1.97" DIA
- Applicable for rectangular workpieces with thickness: ≤1.38"

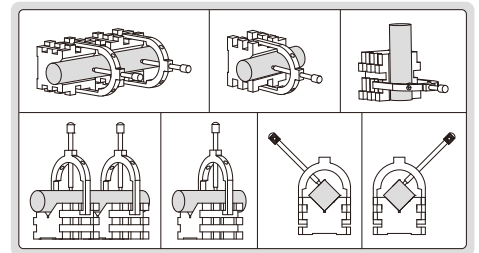

Part No.	Size (LxWxH)	Parallelism of V groove to top, bottom, left, right sides	Squareness of V groove to front and back sides	Height difference of a matched pair
6802-1	2.6x2.8x2.0"	197µin	197µin	197µin

13

## V-BLOCK SETS

SIDE LIE-DOWN USE IS POSSIBLE

- Hold cylindrical workpieces for inspection and machining
- Two V-blocks per set
- Made of alloy steel
- Hardened to HRC60±2
- V groove on the top for large shafts
- V groove on the bottom for small shafts



6803-1

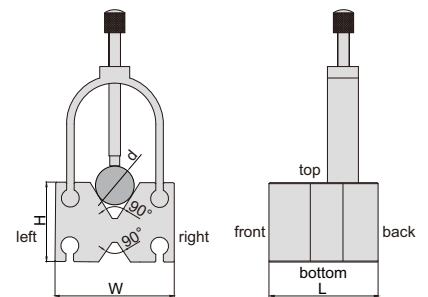

Part No.	Size (LxWxH)	Range of shafts (d)	Parallelism of both V grooves to top, bottom, left, right sides	Squareness of both V grooves to front and back sides	Height difference of a matched pair
6803-1	2.2x2.4x1.6"	.16-1.38" DIA	197µin	197µin	197µin
6803-2	2.6x2.8x1.8"	.16-1.85" DIA	197µin	197µin	197µin

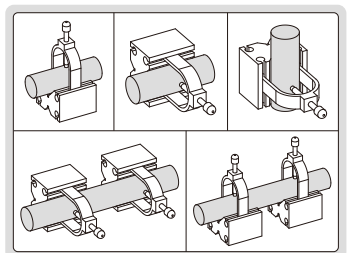



## V-BLOCK

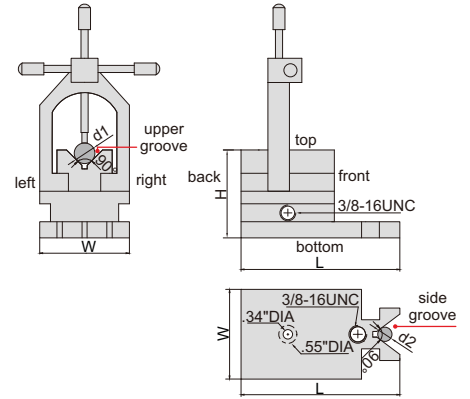

6804-1

- Hold cylindrical workpieces for inspection and machining
- Made of alloy steel
- Hardened to HRC60±2

Part No.	Size (LxWxH)	Range of shafts (d1 and d2)	Parallelism of upper groove to bottom, left and right sides	Squareness of upper groove to back side	Parallelism of side groove to back side
6804-1	3.5x1.9x1.9"	.20-1.30" DIA	197µin	197µin	197µin

## V-BLOCK SETS

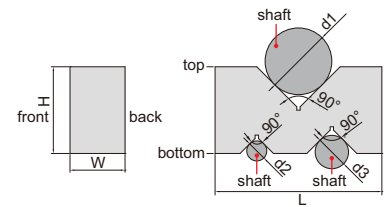
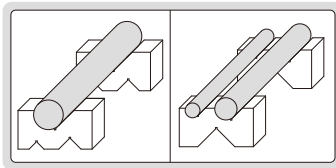

6887-3

- Two V-blocks per set
- Made of hardened tool steel

Part No.	Size (LxWxH)	Range of shafts (d1)	Range of shafts (d2)	Range of shafts (d3)	Part No.	Parallelism of three V grooves to top and bottom sides	Height difference of a matched pair
6887-1	2.0x.7x.9"	.12-1.26" DIA	.12-.63" DIA	.12-.87" DIA	6887-1	197µin	197µin
6887-2	3.0x.9x1.4"	.12-1.97" DIA	.12-.79" DIA	.12-1.26" DIA	6887-2	197µin	197µin
6887-3	3.9x1.3x2.0"	.12-2.68" DIA	.12-1.02" DIA	.12-1.57" DIA	6887-3	197µin	197µin
6887-4	4.9x1.7x2.7"	.12-3.43" DIA	.12-1.34" DIA	.12-1.97" DIA	6887-4	197µin	197µin

## GRANITE V-BLOCK SETS

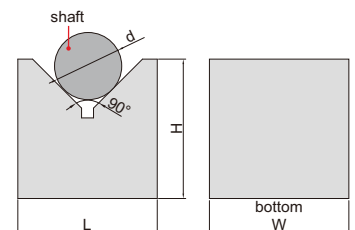
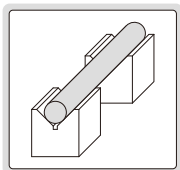

6897-1

- Two V-blocks per set

Part No.	Size (LxWxH)	Range of shafts (d)	Parallelism of V groove to bottom	Height difference of a matchet pair
6897-1	2.8x2.0x2.8"	.24-2.95" DIA	157µin	197µin
6897-2	3.9x2.0x2.8"	.24-3.90" DIA	157µin	197µin

## ROLLER BEARING V-BLOCK SETS

- Runout accuracy: 197µin
- Parallelism of bearings to bottom: 472µin
- Two V-blocks per set
- Workpieces don't get damaged due to bearings
- Suitable for heavy workpieces



6888-1

Part No.	W1	W2	h1	h2	h3	L1	L2	S
6888-1	.87"	1.73"	.79"	3.35"	.47"	3.94"	-	2.36"
6888-2	1.57"	2.36"	.87"	3.35"	.47"	3.94"	-	1.97"
6888-3	2.36"	3.15"	1.18"	4.88"	.79"	7.09"	3.54"	4.72"

Part No.	Size (LxWxH)	Part No. of bearings	Diameter of bearings (D)	Range of shafts (d)	Load capacity
6888-1	5.9x2.4x3.9"	6303 ZZ	1.65" DIA	.98-2.76" DIA	1100lb
6888-2	5.9x3.1x3.9"	16004 ZZ	1.85" DIA	.20-2.17" DIA	2200lb
6888-3	9.1x3.9x5.9"	6306 ZZ	2.83" DIA	2.76-7.87" DIA	2200lb

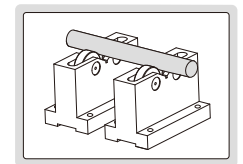
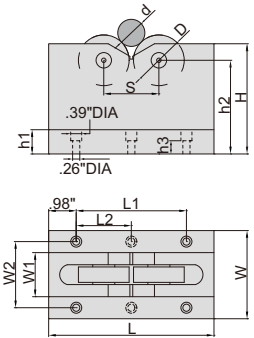

## MAGNETIC V-BLOCKS

HARDENED SURFACES

HIGH PRECISION

STRONG MAGNETIC FORCE

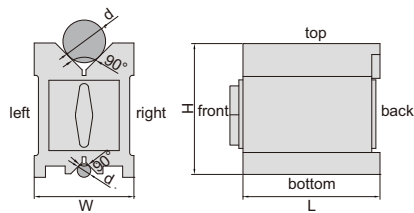

6889-11

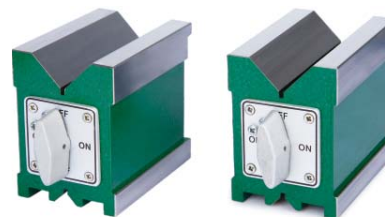

6889-1

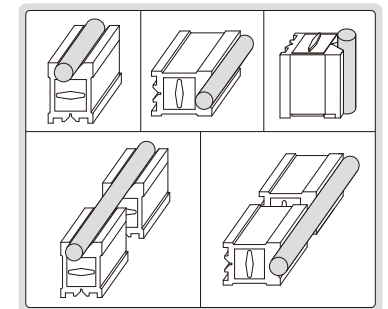

- Hardened, high accuracy, strong magnetic force, for grinding, light milling, drilling and inspection of round and square jobs
- All working surfaces are hardened to HRC60±2
- Magnetic force on top, bottom and two V grooves
- V groove on the top for large shafts
- V groove on the bottom for small shafts
- Suitable for cast iron surface plates and granite surface plates

### Individual

Part No.	Size (LxWxH)	Range of shafts (d)	Magnetic force	Parallelism of V groove to top, bottom, left, right sides	Squareness of V groove to back side
6889-11	3.0x2.2x3.0"	.20-1.57"DIA	165lbf	197µin	197µin
6889-22	3.9x2.8x3.7"	.20-2.56"DIA	220lbf	197µin	197µin
6889-33	5.9x3.0x3.9"	.20-2.76"DIA	275lbf	197µin	197µin
6889-44	7.9x4.9x5.9"	.39-5.51"DIA	385lbf	394µin	394µin

### Matched pair

Part No.	Size (LxWxH)	Range of shafts (d)	Magnetic force	Parallelism of V grooves to top, bottom, left, right sides	Squareness of V grooves to back side	Height difference of a matched pair
6889-1	3.0x2.2x3.0"	.20-1.57"DIA	165lbf	197µin	197µin	197µin
6889-2	3.9x2.8x3.7"	.20-2.56"DIA	220lbf	197µin	197µin	197µin
6889-3	5.9x3.0x3.9"	.20-2.76"DIA	275lbf	197µin	197µin	197µin
6889-4	7.9x4.9x5.9"	.39-5.51"DIA	385lbf	394µin	394µin	394µin

## MAGNETIC V-BLOCK

- Hold cylindrical workpieces for inspection and machining
- Supplied in single piece
- Not hardened
- Not suitable for steel or iron surface

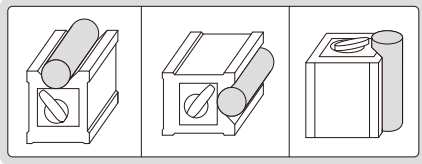

6890-702

ATTENTION: NOT SUITABLE FOR STEEL OR IRON SURFACE

ATTENTION: NOT HARDENED

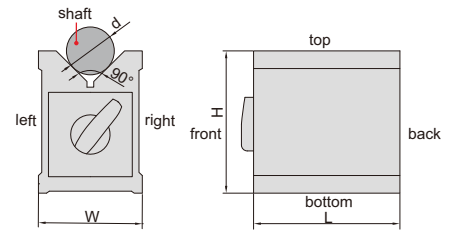

Part No.	Size (LxWxH)	Range of shafts (d)	Magnetic force	Parallelism of V groove to top, bottom, left and right sides	Squareness of V groove to back side
6890-702	2.8x2.4x2.9"		123lbf	394µin	394µin

## MAGNETIC V-BLOCKS

- Hold cylindrical workpieces for inspection and machining
- Supplied in single piece
- Not hardened
- V groove on the top for large shafts
- V groove on the bottom for small shafts
- Not suitable for steel or iron surface

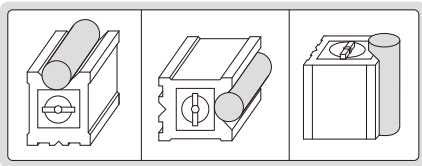

6801-1201

ATTENTION: NOT SUITABLE FOR STEEL OR IRON SURFACE

ATTENTION: NOT HARDENED

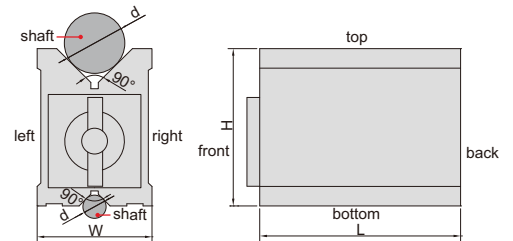

Part No.	Size (LxWxH)	Range of shafts (d)	Magnetic force	Parallelism of V grooves to top, bottom, left, right side	Squareness of V grooves to back side
6801-1201	3.1x2.8x3.7"	.24-2.64" DIA	141lbf	394µin	394µin
6801-1202	3.9x2.8x3.7"	.24-2.64" DIA	176lbf	394µin	394µin
6801-1203	4.7x2.8x3.7"	.24-2.64" DIA	211lbf	394µin	394µin

## MAGNETIC V-BLOCK SETS

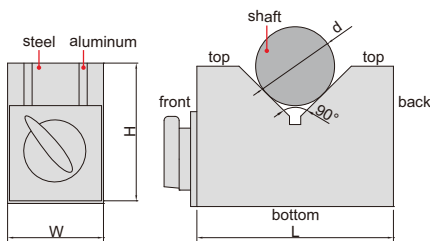

- Hold cylindrical workpieces for inspection, not suitable for machining due to low magnetic force
- Two V-blocks per set
- Hardness HRB70



6891-1

ATTENTION: NO HARDENED SURFACE, DO NOT ROTATE WORKPIECES ON V-BLOCKS

ATTENTION: LOW MAGNETIC FORCE

Part No.	Size (LxWxH)	Range of shafts (d)	Magnetic force	Parallelism of V groove to bottom and back sides	Height difference of a matched pair
6891-1	2.8x1.6x2.0"	.24-1.81" DIA	18lbf	394µin	394µin
6891-3	5.9x2.0x3.9"	.24-4.92" DIA	31lbf	394µin	394µin

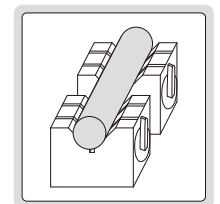

## MAGNETIC INDUCTION V-BLOCK

- Hold cylindrical workpieces for inspection and machining
- To be used on magnetic chucks
- Supplied in single piece
- V groove on the top for large shafts
- V groove on the bottom for small shafts
- Hardness HRB70

ATTENTION: NO HARDENED SURFACE, DO NOT ROTATE WORKPIECES ON V-BLOCKS

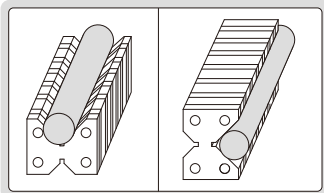

6892-1

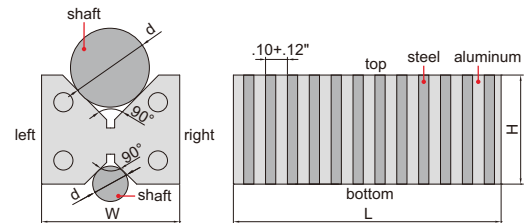

Part No.	Size (LxWxH)	Range of shafts (d)	Pole pitch	Parallelism of both V grooves to top, bottom, left, right sides
6892-1	4.3x2.4x1.9"	.24-1.97" DIA	.10+.12"	394µin

## MAGNETIC INDUCTION V-BLOCK SET

- Hold cylindrical workpieces for inspection and machining
- To be used on magnetic chucks
- Two V-blocks per set
- V groove on the top for large shafts
- V groove on the bottom for small shafts
- Hardness HRB70

ATTENTION: NO HARDENED SURFACE, DO NOT ROTATE WORKPIECES ON V-BLOCKS

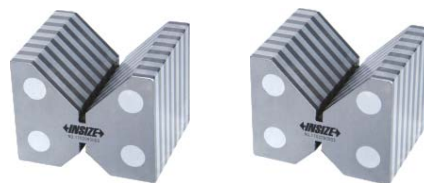
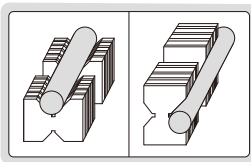

6899-1

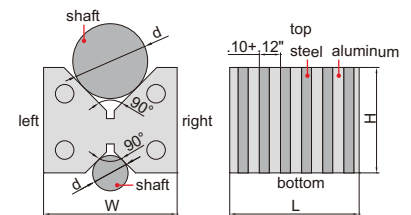

Part No.	Size (LxWxH)	Range of shafts (d)	Pole pitch	Parallelism of both V grooves to top, bottom, left and right sides	Height difference of a matched pair
6899-1	2.2x2.4x1.9"	.24-1.97" DIA	.10+.12"	394µin	394µin

## 1-2-3 BLOCKS

screws and wrench are included



- Pairs of matched blocks for positioning and set-up
- Screws and wrench are included
- Hardness HRC 55-62



6531-5

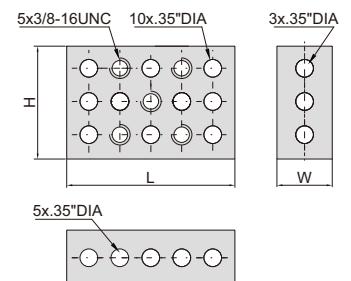

Part No.	Size (LxHxW)	Size accuracy	Squareness	Parallelism	Height difference of a matched pair
6531-5	3x2x1"	±.0002"	.0001"/1"	.0002"	.0002"

## PARALLEL SETS

- Parallelism between top and bottom .0003"
- Height difference of a matched pair .0003"
- Hardened HRC55-62
- With two holes in each parallel

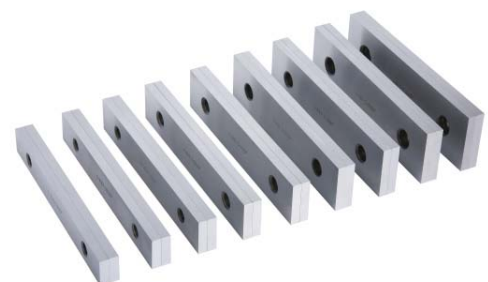
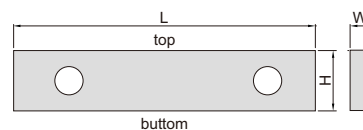

6532-9

Part No.	Quantity	Length (L)	Thickness (W)	Height (H)
6532-10	10 pairs	6"	1/8"	1/2, 5/8, 3/4, 7/8, 1, 1-1/8, 1-1/4, 1-3/8, 1-1/2, 1-5/8"
6532-9	9 pairs	6"	1/4"	3/4, 7/8, 1, 1-1/8, 1-1/4, 1-3/8, 1-1/2, 1-5/8, 1-3/4"

## ANGLE PLATE SETS

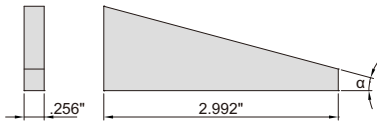

4003-12

- For angle set-up in tooling, production and inspection
- Made of tool steel
- Hardness HRC55

Part No.	Angle plates included	Angle $\alpha$	Accuracy
4003-10	10 pcs	1°, 2°, 3°, 4°, 5°, 10°, 15°, 20°, 25°, 30°	±9"
4003-12	12 pcs	1/4°, 1/2°, 1°, 2°, 3°, 4°, 5°, 10°, 15°, 20°, 25°, 30°	±9"

## UNIVERSAL ANGLE PLATE SET

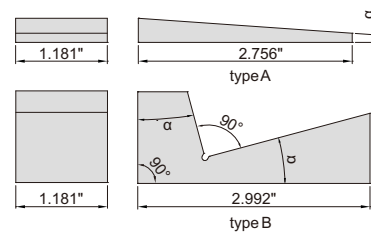

- For angle set-up in tooling, production and inspection
- Made of tool steel
- Hardness HRC55



4004-9

Part No.	Angle plates included	Angle $\alpha$	Type	Accuracy
4004-9	9 pcs	1/2°, 1°, 2°, 3°, 4°, 5°	type A	±30"
		10°, 15°, 30°	type B	±50"

## ADJUSTABLE ANGLE BLOCKS

- Made of hardened tool steel
- With locking screw
- Accuracy of angle: 10'

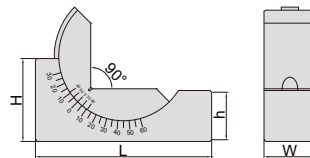

6535-30

Part No.	Size (LxWxH)	h	Adjustable angle	Graduation of angle
6535-25	3.0x1.0x1.4"	.98"	30°~0°~60°	10'
6535-30	4.0x1.2x1.9"	1.18"	30°~0°~60°	10'

## RIGHT ANGLE PLATE

- Hardened to HRC60±2
- V groove for cylinders
- Parallelism and squareness between A, B, C, D, E, F, G and H: 236µin
- Parallelism and squareness of V groove to A, B, C, D, E, F, G and H: 236µin

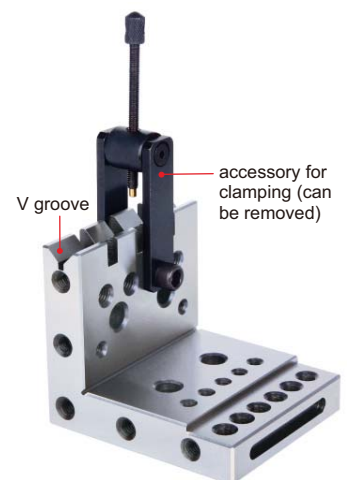
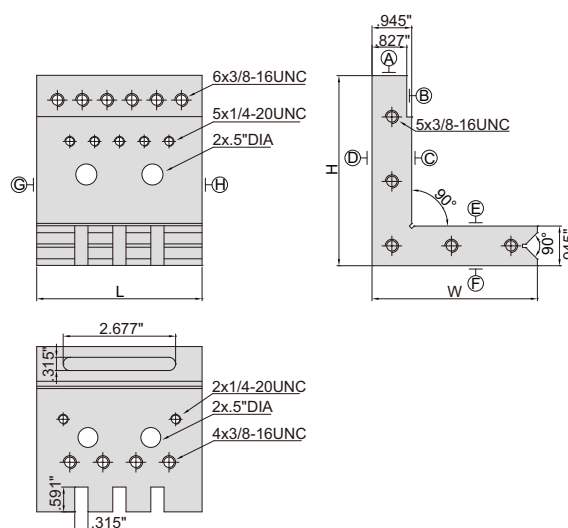

6547-E1

Part No.	Size (LxWxH)
6547-E1	3.9x3.9x4.5"



## PRECISION UNIVERSAL VISE

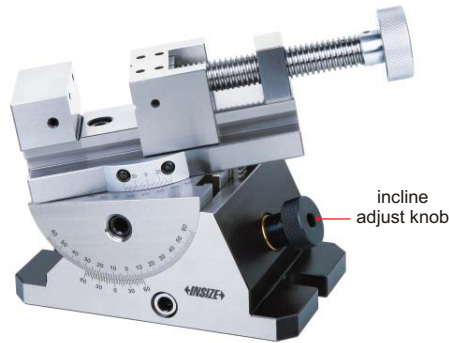

6521-80

- Horizontal rotary: range 360°, graduation 0.05°
- Vertical incline: range 45°, graduation 0.05°
- With incline adjust knob
- Parallelism and squareness between A, B, C and D: 50µin/per inch, parallelism between D and E at 0°: 100µin/per inch
- Made of tool steel
- Hardness HRC56-58

Part No.	Jaw opening (Q)	Jaw width (W)
6521-80	0-3.1"	2.756"

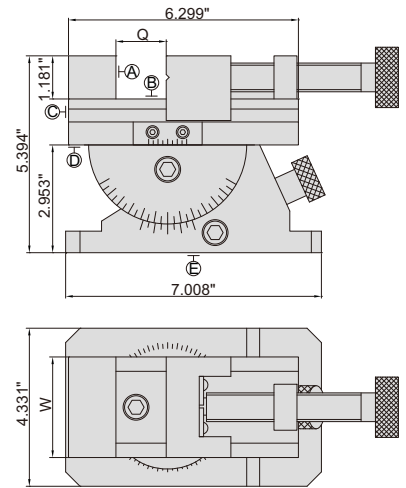

## PRECISION VISES

13



6525-76

- Parallelism: 40µin/per inch
- Squareness: 60µin/per inch
- Made of alloy steel
- Hardness HRC56-58

Part No.	Jaw opening (Q)	Jaw width (W)	L	H	M
6525-73	0-2.9"	2.480"	6.929"	2.480"	1.181"
6525-76	0-3.0"	2.874"	7.480"	2.874"	1.378"
6525-120	0-4.7"	3.858"	10.039"	3.228"	1.575"

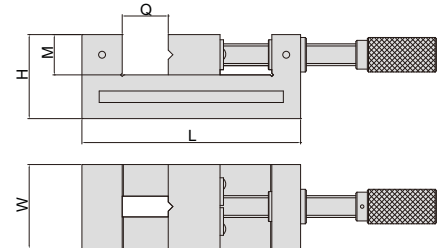

## PRECISION VISES



6526-80

- Parallelism: 30µin/per inch
- Squareness: 50µin/per inch
- Made of alloy steel
- Hardness HRC56-58

Part No.	Jaw opening (Q)	Jaw width (W)	Overall length (L)	H	M
6526-80	0-3.1"	1.969"	5.906"	2.087"	.984"
6526-100	0-3.9"	2.874"	7.480"	2.756"	1.378"

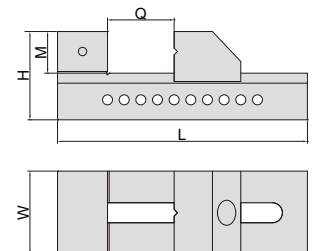

COMPACT DESIGN

ANTI MAGNETIC CARBIDE CONTACT POINT

### 3D TESTER

**INSIZE PLUS**  
MADE IN GERMANY

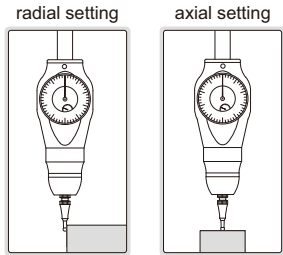
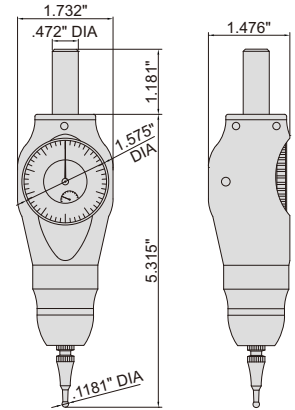

2842-3D

Part No.	Range	Graduation	Accuracy
2842-3D	1.5mm/.059"	0.01mm	0.01mm/.0004"

Probe (optional)

Part No.	Name	L	D
2842-N1	standard probe	1.063"	.1181" DIA
2842-N2	long probe	2.441"	.2362" DIA

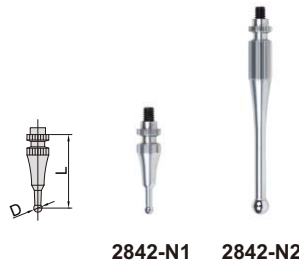

If probe tip is pressed too much, the probe breaks at the breaking point, in order to prevent damage of main body

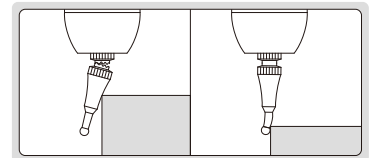

### CENTERING INDICATOR

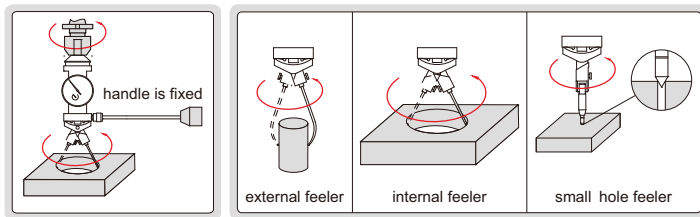

2385-3

- Provides quick and accurate centering in boring and milling set-up

Feeler	Measuring diameter	Accuracy
P1	0-2.362" DIA	±.0015"
P2	0-6.299" DIA	±.0023"
P3	0-9.843" DIA	±.0031"
P4	.126-3.150" DIA	±.0015"
P5	.126-7.087" DIA	±.0023"
P6	.126-11.024" DIA	±.0031"
P7	0-.110" DIA	±.0015"

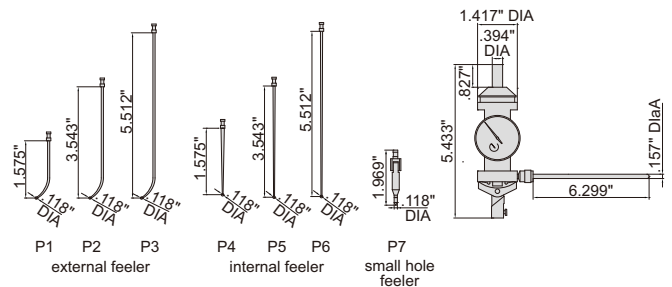

Part No.  
**2385-3**

## DIAL TEST INDICATOR CENTERING HOLDER

- Center cylinders or holes on machine tools
- Can be used with dial test indicators

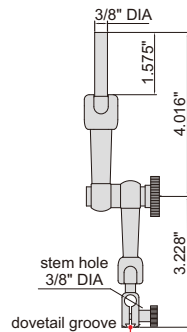

Part No.  
6295-1AE



6295-1AE



## INDICATOR CENTERING HOLDER

- Center cylinders or holes on machine tools
- Can be used with dial test indicators or dial indicators

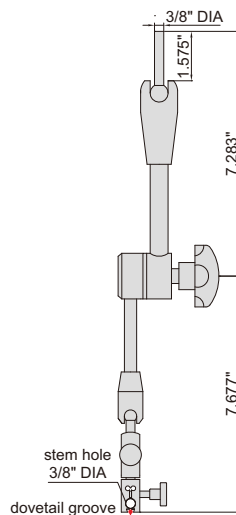

Part No.  
6294-1AE



6294-1AE



## ELECTRONIC EDGE FINDERS

- The shank is electrically conducted to the metal workpiece through the chuck and table, the LED lights up and the beeper sounds (only for 6566-3E), when the ball touches the workpiece
- Not suitable for rotary use
- Hardened shank and contact ball

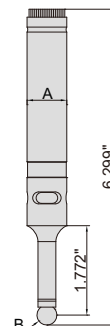
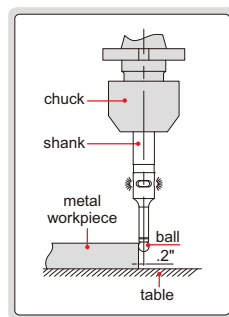

6566-2E

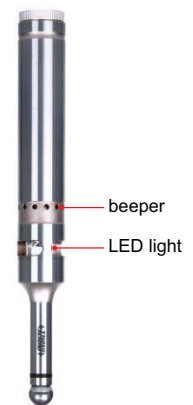

6566-3E

Part No.	Shank (A)	Contact ball (B)	Accuracy	Beeper	Battery
6566-2E	3/4" DIA	.4" DIA	.0002"	without	23AE, 12Vx1 pc
6566-3E	3/4" DIA	.4" DIA	.0002"	with	23AE, 12Vx1 pc

## EDGE AND CENTER FINDER

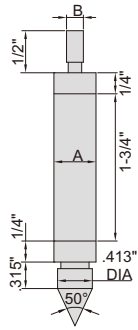

- Hardened shank and contact point
- To find edge and hole center

Part No.	Shank (A)	Contact point (B)	Accuracy
6569-1E	1/2" DIA	.2" DIA	±.0002"

6569-1E

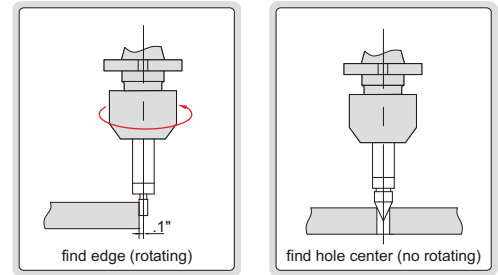

## EDGE FINDER

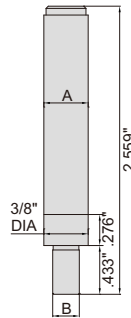

- Hardened shank and contact point

Part No.	Shank (A)	Contact point (B)	Accuracy
6567-1E	3/8" DIA	.2" DIA	.0003"

6567-1E

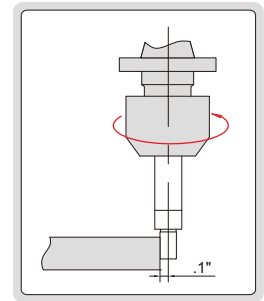

**ATTENTION:**  
HIGH TEST FORCE

- The base is electrically conducted to the cutting tools through the table and chuck, the LED lights up when the cutting tool touches the anvil
- Magnetic base
- Battery LR44



6550-2A

## ELECTRONIC ZERO SETTER

Part No.	Height (H)	Accuracy	Test force
6550-2A	2"	±.0004"	6lbf (at 2")

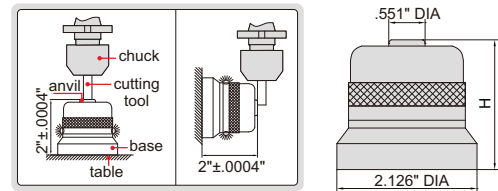

## ZERO SETTER

- Magnetic base

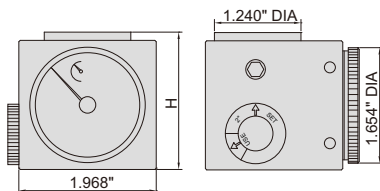

Part No.	Height (H)	Accuracy	Test force
2397-25A	2"	±.0004"	2lbf (at 2")



2397-25A

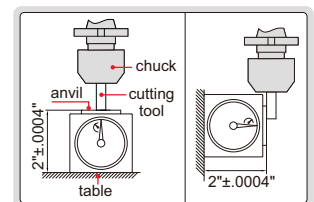

## ZERO SETTER

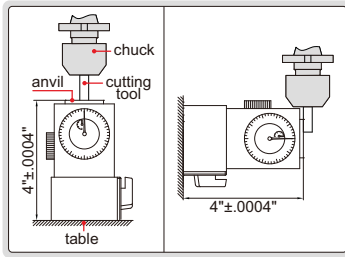

2394-45A

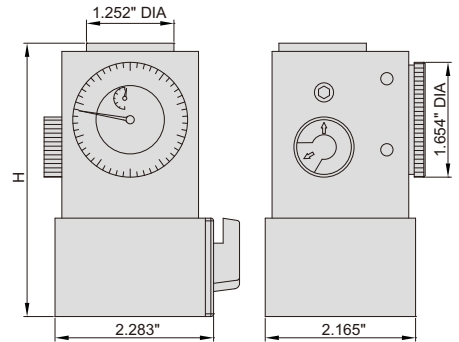

- Magnetic base with on-off switch

Part No.	Height (H)	Accuracy	Test force
2394-45A	4"	±.0004"	2lbf (at 4")

## ELECTRONIC HORIZONTAL SCALES

DATA OUTPUT



7101-300A



7101-400A

type A

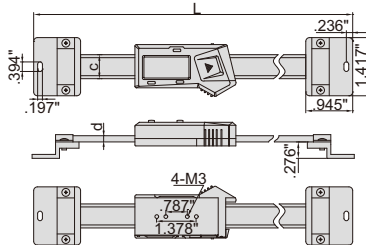

- Resolution .0005"/0.01mm
- Buttons: on/off, zero, inch/mm
- Automatic power off, move the digital unit to turn on power
- Battery CR2032, data output
- Made of stainless steel
- Supplied with bracket to be mounted on the back
- Optional accessory: data output cable (part no. 7306-20, 7302-SPC5A/SPC5B, 7305-SPC2A, 7305-A01/A02)

type B

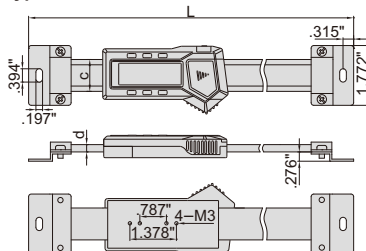

- Resolution .0005"/0.01mm
- Button function: on/off, zero, inch/mm, ABS, data preset
- Absolute and incremental measurement
- Battery CR2032, data output
- Made of stainless steel
- Supplied with bracket to be mounted on the back
- Optional accessory: data output cable (part no. 7306-20, 7302-SPC5A/SPC5B, 7305-SPC2A, 7305-A01/A02)

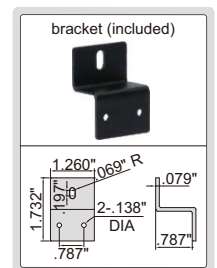

Part No.	Range	Type	Accuracy	L	c	d
7101-100A	4"/100mm	A	±.0008"	8.465"	.630"	.157"
7101-150A	6"/150mm	A	±.0012"	10.433"	.630"	.157"
7101-200A	8"/200mm	A	±.0012"	12.402"	.630"	.157"
7101-300A	12"/300mm	A	±.0016"	17.520"	.630"	.157"
7101-400A	16"/400mm	B	±.0020"	23.228"	.945"	.217"
7101-500A	20"/500mm	B	±.0020"	27.165"	.945"	.217"
7101-600A	24"/600mm	B	±.0031"	31.102"	.945"	.217"
7101-800A	32"/800mm	B	±.0039"	38.976"	.945"	.217"
7101-1000A	40"/1000mm	B	±.0039"	46.850"	1.220"	.413"

example of application

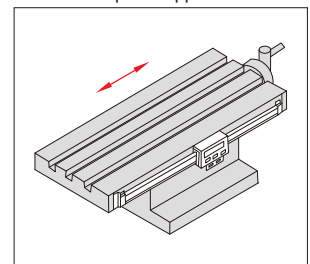



**DATA OUTPUT**

data output cable



7301-SPC5

- Resolution .0005"/0.01mm
- Buttons: on/off, zero, inch/mm, ABS/INC, data hold, TOL, set
- ABS/INC is for absolute and incremental measurement
- TOL is for tolerance measurement
- Battery LR44
- Made of stainless steel
- Data output
- Supplied with bracket to be mounted on the back
- Optional accessory: data output cable (part no. 7301-SPC5)

example of application

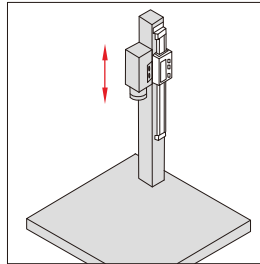

Part No.	Range	Accuracy	B	C	D	E	F	L
7102-100	4"/100mm	±.0008"	.157"	.787"	.236"	.945"	1.575"	9.646"
7102-150	6"/150mm	±.0012"	.157"	.787"	.236"	.945"	1.575"	11.654"
7102-200	8"/200mm	±.0012"	.157"	.787"	.236"	.945"	1.575"	13.583"
7102-300	12"/300mm	±.0016"	.157"	.787"	.236"	.945"	1.575"	17.520"
7102-400	16"/400mm	±.0020"	.157"	.787"	.236"	.945"	1.575"	21.457"
7102-500	20"/500mm	±.0020"	.217"	.945"	.315"	1.260"	1.772"	26.969"
7102-600	24"/600mm	±.0031"	.217"	.945"	.315"	1.260"	1.772"	30.906"
7102-800	32"/800mm	±.0039"	.217"	.945"	.315"	1.260"	1.772"	38.780"
7102-1000	40"/1000mm	±.0039"	.413"	1.220"	.984"	1.575"	2.362"	49.016"

**ELECTRONIC VERTICAL SCALES**

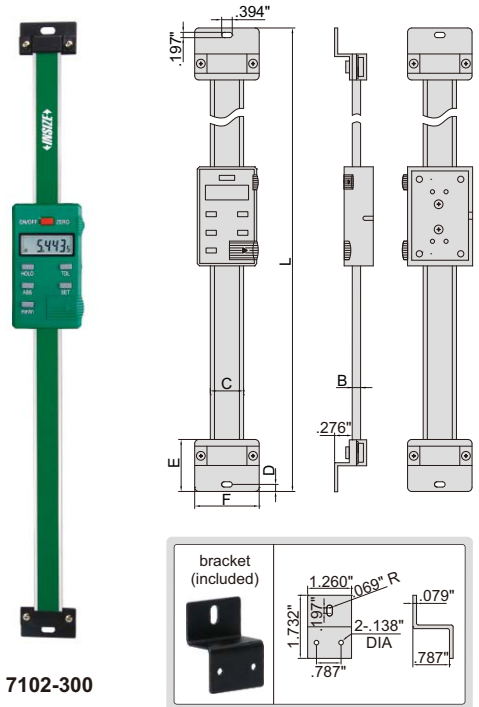

7102-300

**COUNTERS**

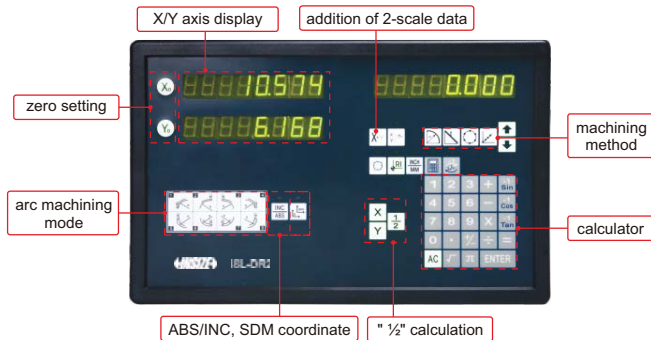

ISL-DR2

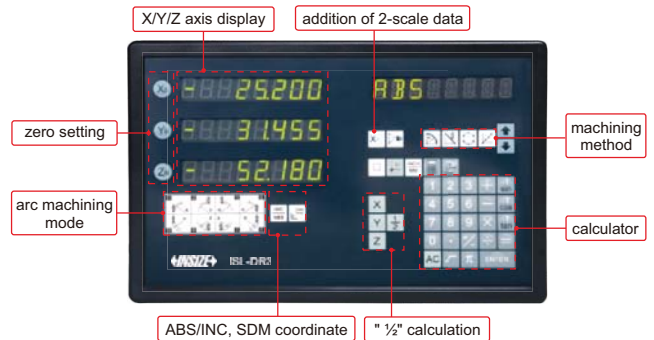

ISL-DR3

**SPECIFICATION**

Part No.	ISL-DR2	ISL-DR3
Application	two-axis	three-axis
Scale input ports	2	3
Resolution	.000002", .000005", .00001", .00002", .00005", .0001", .0002", .0005", .001", .002"	
Functions	addition of 2-scale data, linearity error compensation, smoothing, RS232C interface unit, BCD code out, zero setting, preset, resolution setting, counting direction setting, inch/mm conversion, ABS/INC conversion, expansion/contraction coefficient setting, "1/2" calculation, detecting RI, bolt-hole circle machining, ramp circle machining	
Power supply	110/220V, 50/60Hz	
Dimension	11.61×7.28×1.77"	
Weight	3.20lb	

**STANDARD DELIVERY**

Main unit	1 pc
Mounting bracket	1 pc
Ground cable	1 pc
RS232C cable	1 pc
Software CD for RS232C	1 pc



# LINEAR SCALES

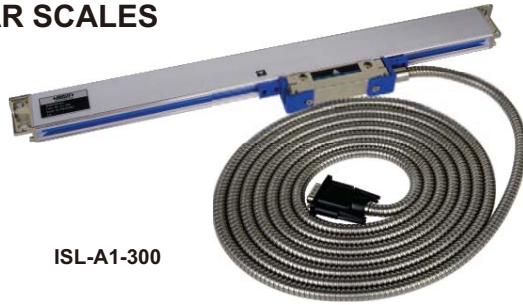

ISL-A1-300

### Series ISL-A1 and ISL-A5

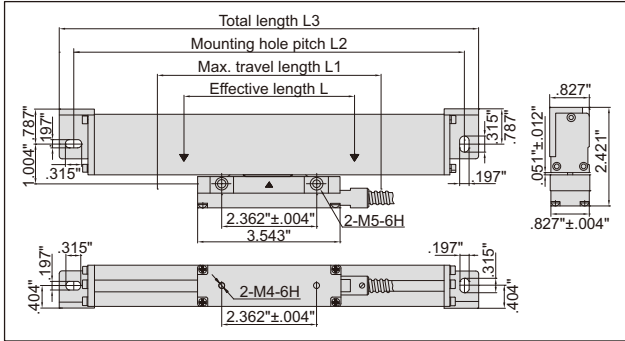

### Series ISL-B5

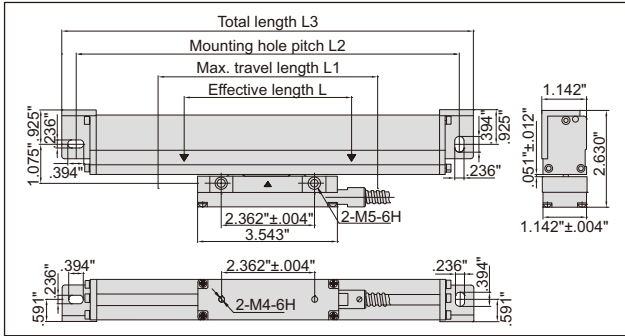

Effective length (L)	Part No.		
	Series ISL-A1	Series ISL-A5	Series ISL-B5
2"/50mm	ISL-A1-50	ISL-A5-50	ISL-B5-50
4"/100mm	ISL-A1-100	ISL-A5-100	ISL-B5-100
6"/150mm	ISL-A1-150	ISL-A5-150	ISL-B5-150
8"/200mm	ISL-A1-200	ISL-A5-200	ISL-B5-200
10"/250mm	ISL-A1-250	ISL-A5-250	ISL-B5-250
12"/300mm	ISL-A1-300	ISL-A5-300	ISL-B5-300
14"/350mm	ISL-A1-350	ISL-A5-350	ISL-B5-350
16"/400mm	ISL-A1-400	ISL-A5-400	ISL-B5-400
18"/450mm	ISL-A1-450	ISL-A5-450	ISL-B5-450
20"/500mm	ISL-A1-500	ISL-A5-500	ISL-B5-500
22"/550mm	ISL-A1-550	ISL-A5-550	ISL-B5-550
24"/600mm	ISL-A1-600	ISL-A5-600	ISL-B5-600
26"/650mm	ISL-A1-650	ISL-A5-650	ISL-B5-650
28"/700mm	ISL-A1-700	ISL-A5-700	ISL-B5-700
30"/750mm	ISL-A1-750	ISL-A5-750	ISL-B5-750
32"/800mm	ISL-A1-800	ISL-A5-800	ISL-B5-800
34"/850mm	ISL-A1-850	ISL-A5-850	ISL-B5-850
36"/900mm	ISL-A1-900	ISL-A5-900	ISL-B5-900
38"/950mm	ISL-A1-950	ISL-A5-950	ISL-B5-950
40"/1000mm	ISL-A1-1000	ISL-A5-1000	ISL-B5-1000
44"/1100mm		ISL-A5-1100	ISL-B5-1100
48"/1200mm			ISL-B5-1200
52"/1300mm			ISL-B5-1300
56"/1400mm			ISL-B5-1400
60"/1500mm			ISL-B5-1500
64"/1600mm			ISL-B5-1600
68"/1700mm			ISL-B5-1700
72"/1800mm			ISL-B5-1800
76"/1900mm			ISL-B5-1900
80"/2000mm			ISL-B5-2000
84"/2100mm			ISL-B5-2100
88"/2200mm			ISL-B5-2200
92"/2300mm			ISL-B5-2300
96"/2400mm			ISL-B5-2400
100"/2500mm			ISL-B5-2500
104"/2600mm			ISL-B5-2600
108"/2700mm			ISL-B5-2700
112"/2800mm			ISL-B5-2800
116"/2900mm			ISL-B5-2900
120"/3000mm			ISL-B5-3000
124"/3100mm			ISL-B5-3100
128"/3200mm			ISL-B5-3200

14

### STANDARD DELIVERY

Main unit	1 pc
'L' shape support	1 pc
Anti-dust cover	1 pc
Plain base	1 pc (for L≥60")
Mounting accessories	1 package

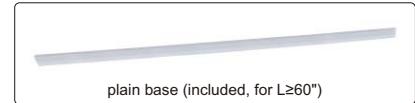
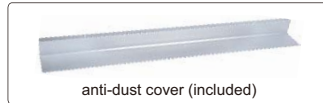
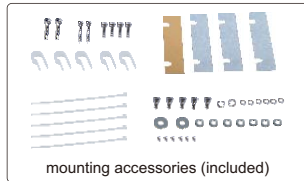
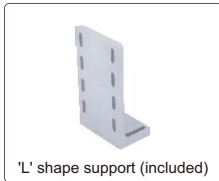

### SPECIFICATION

Part No.	Series ISL-A1		Series ISL-A5		Series ISL-B5	
	L1 (inch)	L+1.18"(L<38")	L+1.97"(L≥38")	L+1.18"(L<38")	L+1.97"(L≥38")	L+1.18"(L<38")
L2 (inch)	L+5.20"(L<38")	L+5.98"(L≥38")	L+5.20"(L<38")	L+5.98"(L≥38")	L+5.35"(L<38")	L+6.14"(L≥38")
L3 (inch)	L+5.87"(L<38")	L+6.65"(L≥38")	L+5.87"(L<38")	L+6.65"(L≥38")	L+6.06"(L<38")	L+6.85"(L≥38")
Resolution	.00005"		.0002"		.0002"	
Max. response speed	164ft/min		295ft/min		196ft/min	
Scale grating pitch	787µin					
Scale reference point pitch	1.97"					
Accuracy	±(197+5L)µin L is the effective length in inch					
Cable length	140" (L: 2-38"), 200" (L: 40-60"), 400" (L: 64-128")					

PROGRAMMABLE FOR  
AUTOMATIC CYCLE MEASUREMENT

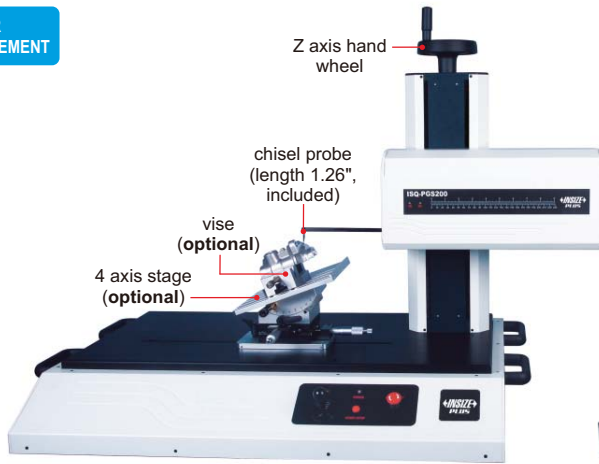

## CONTOUR MEASURING MACHINE PART NO. ISQ-PGS200

**INSIZE PLUS**  
MADE IN ITALY



computer (optional)



software CD  
(included)

- Software is included, for contour measurement and data output
- Programmable for automatic cycle measurement, automatically scan contour, mark dimensions, make report, save and print results
- Operation system: Windows XP/7/8/Vista
- Output as format pdf, jpg, dxf, etc.

### STANDARD DELIVERY

Main unit	1 pc
Chisel probe (ISQ-PGS-T01)	1 pc
Software CD	1 pc
USB cable	1 pc

### OPTIONAL ACCESSORY

Calibration block	ISQ-PGS-CLB
4 axis stage	ISQ-PGS-TABLE
Vise	ISQ-PGS-VISE
Probe	see details

### SPECIFICATION

X axis	Measuring range	7.87"
	Resolution	.02"
	Accuracy	±(39.4+12.5L)µin, L is the measuring length in inch
Z axis	Measuring range	1.97"
	Resolution	.008"
	Accuracy	±(39.4+33.3H)µin, H is the measuring height in inch
Traverse speed		0~.4"/s
Measuring speed		.008"/s, .02"/s, .04"/s, .08"/s
Radius of probe tip		.79µin
Measuring unit		inch/mm
Traverse direction		backward
Measuring force		.1ozf
Traceable angle		75° (upward), 85° (downward)
Travel of Z axis		11.8"
Dimension (L×W×H)		43.3×22.44×28.35"
Power supply		110~240V/50~60Hz
Weight		93lb

### SPECIFICATION OF PROBES

<p><b>chisel probes</b></p> <p>part no. ISQ-PGS-T01 (L=1.26", included) part no. ISQ-PGS-T02 (L=.87", optional) part no. ISQ-PGS-T03 (L=2.05", optional) part no. ISQ-PGS-T04 (L=1.65", optional)</p>	<p><b>.039" DIA ruby ball probe</b></p> <p>part no. ISQ-PGS-R01 (optional)</p>	<p><b>.079" DIA ruby ball probe</b></p> <p>part no. ISQ-PGS-R02 (optional)</p>	<p><b>carbide ball probe</b></p> <p>part no. ISQ-PGS-C01 (.039" DIA ball, optional) part no. ISQ-PGS-C02 (.079" DIA ball, optional)</p>
<p><b>measuring arm and probe for small holes,</b> part no. ISQ-PGS-SBP (optional)</p> <p>measure the contour of holes with diameter&gt;.315" DIA</p>		<p><b>transverse measuring arm and probe ISQ-PGS-T01, part no. ISQ-PGS-LP (optional)</b></p> <p>measure the contour of holes in radial direction</p>	

To be continued

Continued from previous page

**SOFTWARE**

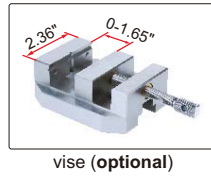
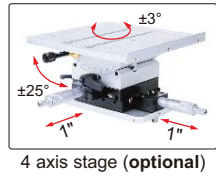
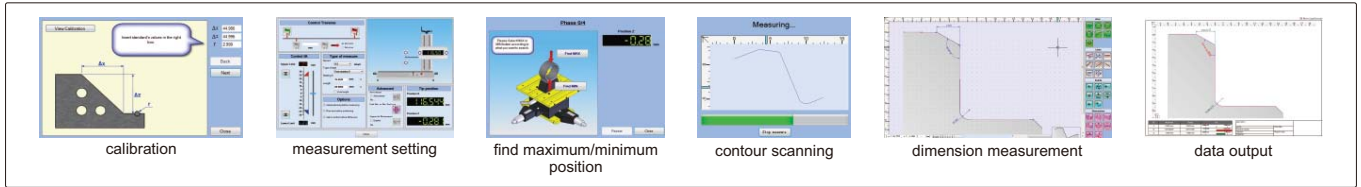

**PROFILE PROJECTOR  
PART NO. ISP-Z3015**



Screen diameter: 12"

X-Y travel: 6x2"

**OPTIONAL ACCESSORY**

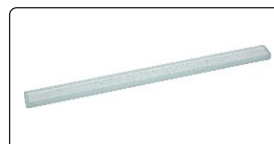
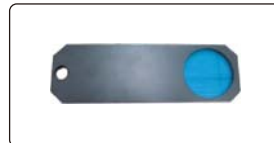
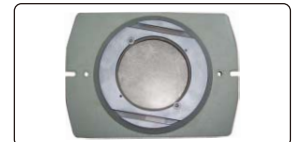
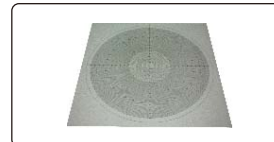
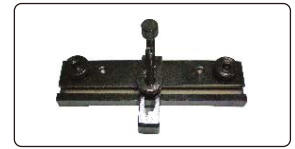









To be continued



Continued from previous page

**SPECIFICATION**

<b>Part No.</b>		<b>ISP-Z3015</b>			
<b>Lens</b>	<b>magnification</b>	10X (included)	20X (optional)	50X (optional)	100X (optional)
	<b>view field</b>	1.18" DIA	.59" DIA	.24" DIA	.12" DIA
	<b>working distance</b>	3.06"	1.74"	1.51"	1.00"
<b>Max. workpiece height</b>		3.54"	3.54"	3.54"	3.54"
<b>Magnification accuracy</b>		±0.08%			
<b>Image</b>		erect image			
<b>Projector screen</b>		diameter: 12" DIA			
		rotation range: 0°~360°, resolution: 1" or 0.01°			
		reference lines: cross-hairs			
<b>Stage</b>	<b>metal stage size</b>	13.39×5.98"			
	<b>glass stage size</b>	7.72×3.78"			
	<b>X-Y stage travel</b>	range: 6×2"			
		resolution .00002"			
		accuracy: (157.5+40L)µin L is the measuring length in inch			
<b>Z (focus) travel range</b>	3.54"				
<b>max. load capacity</b>	8.82lb				
<b>Illumination</b>		contour illumination: 24V/150W halogen lamp, brightness is adjustable			
		surface illumination: 24V/150W halogen lamp			
	<b>display</b>	X-Y stage travel, screen rotation			
	<b>output</b>	RS232C			
<b>Data processing unit</b>	<b>function</b>	 measure coordinate of point			
		 measure coordinate of line			
		 measure center coordinate, radius of circle with three points			
		 measure distance between two objects			
		 measure angle with four points or two lines			
		 set origin of coordinate			
		 coordinate transform			
		 set midpoint of coordinate			
		<b>Power supply</b>		110/220V, 50/60Hz	
<b>Dimension (L×W×H)</b>		21.65×30.31×43.31"			
<b>Weight</b>		297lb			

15

**STANDARD DELIVERY**

<b>Main unit</b>	1 pc
<b>10X lens with half-reflection mirror and oblique illuminator mirror</b>	1 pc
<b>Overlay chart clip</b>	4 pcs
<b>Foot-switch</b>	1 pc
<b>Anti-dust cover</b>	1 pc

**OPTIONAL ACCESSORY**

<b>20X lens with half-reflection mirror and oblique illuminator mirror</b>	<b>ISP-Z3015-LENS20X</b>
<b>50X lens with half-reflection mirror</b>	<b>ISP-Z3015-LENS50X</b>
<b>100X lens with half-reflection mirror</b>	<b>ISP-Z3015-LENS100X</b>
<b>Rotary table</b>	<b>ISP-Z3015-TABLE</b>
<b>Overlay chart</b>	<b>ISP-Z3015-CHART</b>
<b>Holder with clamp</b>	<b>ISP-Z3015-HOLDER</b>

<b>Swivel center support</b>	<b>ISP-Z3015-SUPPORT</b>
<b>V-block with clamp</b>	<b>ISP-Z3015-VBLOCK</b>
<b>50mm/1.97" reading scale</b>	<b>ISP-Z3015-SCALE50</b>
<b>300mm/11.81" calibration scale</b>	<b>ISP-Z3015-RULE</b>
<b>Blue filter</b>	<b>ISP-Z3015-FILTER</b>
<b>Demo sample</b>	<b>ISP-Z3015-DEMO</b>



## VISION MEASURING SYSTEM

**INSPECTION  
CERTIFICATE**



software CD  
(included)



ISD-V250

computer is not included

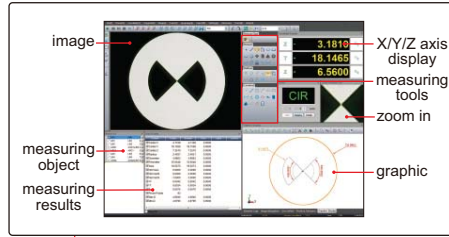

lens with coaxial light  
(optional, must be installed in factory)

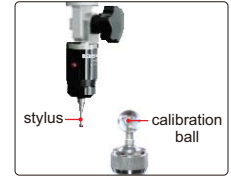

probe (optional), includes  
Ø2mm/.079" DIA and  
Ø3mm/.118" DIA styli,  
Ø25mm/.984" calibration ball,  
measuring accuracy is .0004"

### STANDARD DELIVERY

Main unit	1 pc
Video card with dongle	1 pc
Software disc	1 pc
Calibration glass chart	1 pc
Laser positioner	1 pc
Clay	1 pc
Foot switch	1 pc
Anti-dust cover	1 pc

### SPECIFICATION

Part No.	ISD-V150	ISD-V250	ISD-V300
Measuring range (X×Y×Z)	6×4×8"	10×6×8"	12×8×8"
Stage size	13.94×8.98"	17.72×11.02"	19.69×12.99"
Glass stage size	8.27×6.30"	12.05×7.72"	13.78×9.84"
Resolution of X/Y/Z axis	.00002"		
Accuracy of X/Y axis	≤(98.4+10L)µin L is the measuring length in inch		
Repeatability of X/Y axis	.00008"		
Objective	0.7X~4.5X (zoom)		
Working distance	3.62"		
Magnification	33X~195X (on 19" monitor)		
Camera	1/3" color CCD, 0.3M pixel		
Illumination	surface and contour with adjustable LED		
Max. height of workpiece	6.30"		
Max. weight of workpiece	44lb		
Operation system	Windows 7/8/10		
Drive method	manual		
Power supply	110/220V, 50/60Hz		
Dimension (L×W×H)	22.05×21.26×33.46"	29.92×23.62×35.43"	29.92×23.62×35.43"
Weight	220lb	264lb	308lb

### OPTIONAL ACCESSORY

0.5X auxiliary objective	Part No. <b>ISD-V-OB05X</b> Working distance: 6.89" Magnification: 16.5~97.5X (on 19" monitor)
2X auxiliary objective	Part No. <b>ISD-V-OB2X</b> Working distance: 1.42" Magnification: 66~390X (on 19" monitor)
Probe	Part No. <b>ISD-V-PROBE</b> includes Ø2mm/.079" DIA and Ø3mm/.118" DIA styli, Ø25mm/.984" calibration ball
Lens with coaxial light	Part No. <b>ISD-V-LENS</b> (must be installed in factory)
Vision measuring system with computer	Part No. <b>ISD-V150A, ISD-V250A, ISD-V300A</b>

### SOFTWARE

- Operation system: Windows 7/8/10
- Language: English
- Single measuring tools:

- |  |  |  |  |  |                                  |
|--|--|--|--|--|----------------------------------|
|  | measure distance between two points                    |  | measure length and area of closed curve              |  | measure coordinate of point      |
|  | measure length and diameter of arc                     |  | measure center coordinate and axis length of ellipse |  | measure angle of two lines       |
|  | measure width and diameter of ring                     |  | measure length, width and diameter of key slot       |  | measure distance of two elements |
|  | measure focus distance of surface                      |  | measure length, width and area of rectangle          |  | measure length of open curve     |
|  | measure center coordinate, diameter and area of circle |  |  |  |                                  |

To be continued

Continued from previous page

■ **Combined measuring tools:**

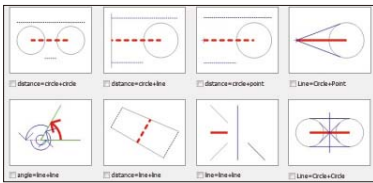

measure distance and angle of two elements

■ **Focus indicator:**

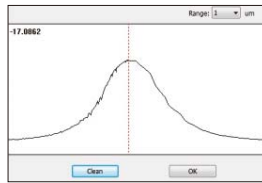

■ **CAD measuring:**

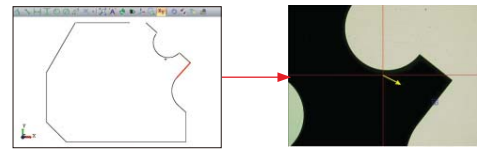

Input CAD drawing and set reference, move the stage to make the target box in the center of crosshair, then the software will do automatic measurement

■ **Coordinate transfer:**

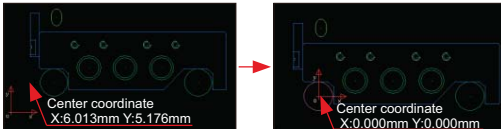

■ **Edge-detection:**



■ **Data export to CAD, EXCEL and WORD:**

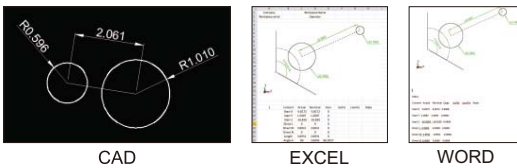

■ **Contour scanning:**

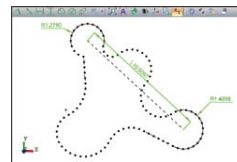

■ **Profile detection:**

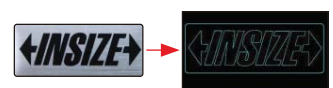

**CNC VISION MEASURING SYSTEM**



software CD (included)

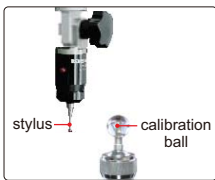

probe (optional), includes Ø2mm/.079" DIA and Ø3mm/.118" DIA styli, Ø25mm/.984" calibration ball, measuring accuracy is .0004"



lens with coaxial light (included)



programmable segmented ring light (included)



ISD-V220CNC

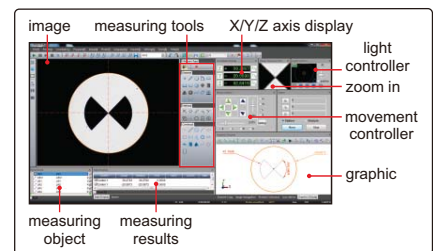

computer is not included



controller

**STANDARD DELIVERY**

Main unit	1 pc
Video card with dongle	1 pc
Software disc	1 pc
Len with coaxial light	1 pc
Controller	1 pc
Calibration glass chart	1 pc
Laser positioner	1 pc
Clay	1 pc
Anti-dust cover	1 pc

- Automatic edge-detection, focus, measuring, contour scanning, calibration, etc.
- Servo motors for X, Y, Z axis
- SPC function for large quantity measurement

To be continued

Continued from previous page

## SPECIFICATION

Part No.	ISD-V220CNC	ISD-V270CNC	ISD-V370CNC
Measuring range (X×Y×Z)	8.66×4.72×5.90"	10.63×6.69×5.90"	14.57×10.63×5.90"
Stage size	17.72×11.02"	19.69×12.99"	23.86×18.35"
Glass stage size	12.05×7.72"	13.78×9.84"	17.72×13.78"
Resolution of X/Y/Z axis	.00002"		
Accuracy of X/Y axis	≤(98.4+10L)μin (L is the measuring length in inch)		
Repeatability of X/Y axis	.00008"		
Objective	0.7X~4.5X (zoom)		
Working distance	3.62"		
Magnification	20X~128X (on 19.5" monitor)		
Camera	1/2" color CCD, 0.4M pixel		
Illumination	surface	coaxial light, programmable segmented ring light	
	contour	adjustable LED	
View field (diagonal length)	.07~.44"		
Max. height of workpiece	6.30"		
Max. weight of workpiece	66lb		
Operation system	Windows 7/8/10		
Drive method	Automatic		
Power supply	110/220V, 50/60Hz		
Dimension (L×W×H)	29.92×23.62×35.43"	29.92×23.62×35.43"	38.19×26.38×37.01"
Weight	322lb	370lb	586lb

## OPTIONAL ACCESSORY

<b>0.5X auxiliary objective</b>	Part No. <b>ISD-V-OB05X</b> Working distance: 6.89" Magnification: 10~64X (on 19.5" monitor)
<b>2X auxiliary objective</b>	Part No. <b>ISD-V-OB2X</b> Working distance: 1.42" Magnification: 66~390X (on 19.5" monitor)
<b>Probe</b>	Part No. <b>ISD-V-PROBE</b> includes Ø2mm/.079" DIA and Ø3mm/.118" DIA styli, Ø25mm/.984" calibration ball
<b>CNC vision measuring system with computer</b>	Part No. <b>ISD-V220CNCA, ISD-V270CNCA, ISD-V370CNCA</b>

## SOFTWARE

- **Operation system:** Windows 7/8/10
- **Language:** English
- **Single measuring tools:**

	measure distance between two points		measure length and area of closed curve		measure coordinate of point
	measure length and diameter of arc		measure center coordinate and axis length of ellipse		measure angle of two lines
	measure width and diameter of ring		measure length, width and diameter of key slot		measure distance of two elements
	measure focus distance of surface		measure length, width and area of rectangle		measure length of open curve
	measure center coordinate, diameter and area of circle				

### ■ Combined measuring tools:

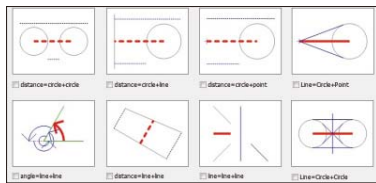

measure distance and angle of two elements

### ■ Focus indicator:

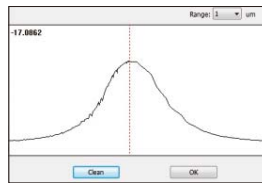

### ■ CAD measuring:

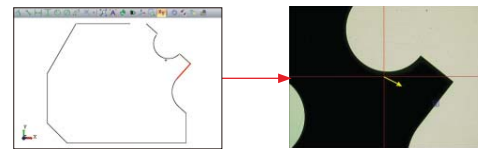

Input CAD drawing and set reference, move the stage to make the target box in the center of crosshair, then the software will do automatic measurement

### ■ Edge-detection:

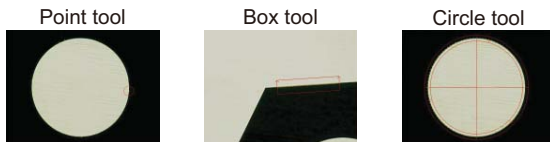

### ■ Coordinate transfer:

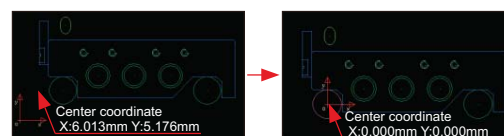

### ■ Data export to CAD, EXCEL and WORD:

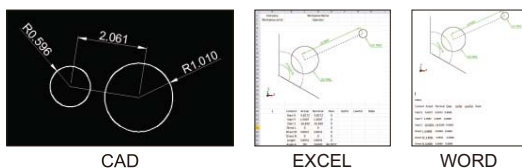

### ■ Contour scanning:

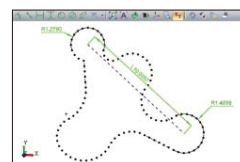

### ■ Profile detection:

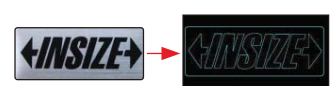

TAKE PICTURES

DIGITAL MICROSCOPE (WITH DISPLAY)  
PART NO. ISM-DL200

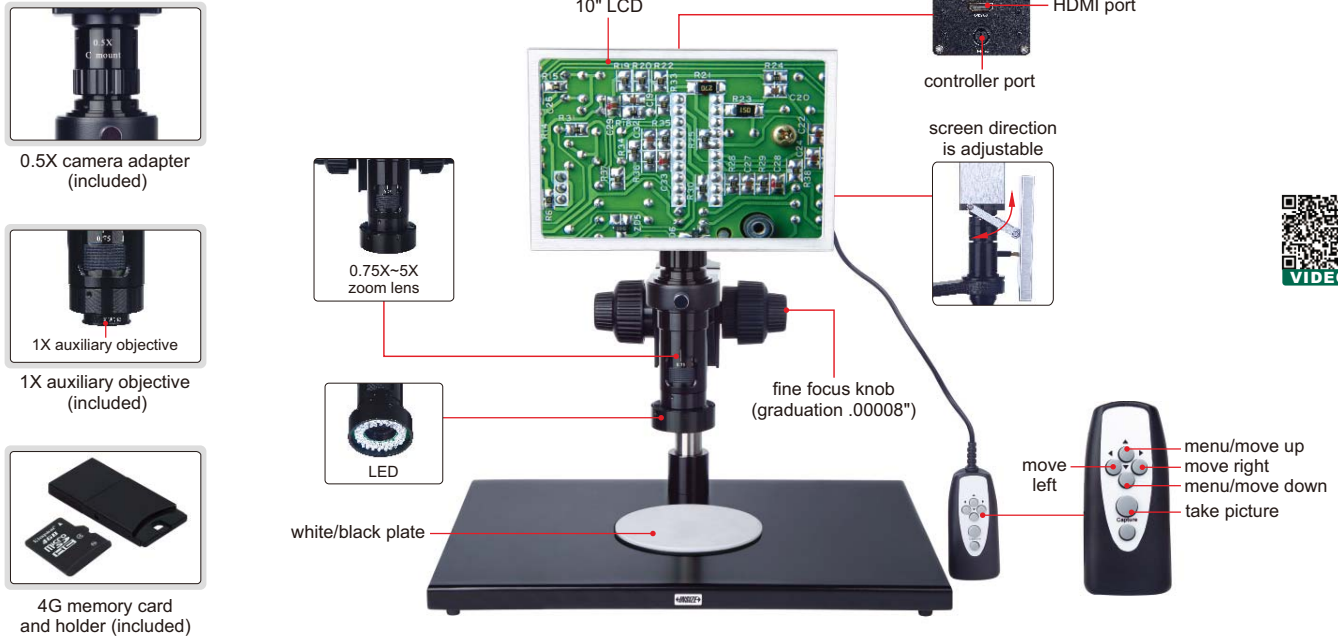

- Take pictures, saved to memory card
- Automatic white balance and exposure
- Brightness, contrast ratio, gain are adjustable

SPECIFICATION

Magnification	18X~112X
Sensor	1/3" CMOS
Pixel	1.3M
Resolution	1280×800
Frame rate	60fps
Output	HDMI
Power supply	power adapter
Dimension (L×W×H)	15.75×11.81×16.93"
Weight	13.33lb

STANDARD DELIVERY

Main unit	1 pc
0.5X camera adapter	1 pc
1X auxiliary objective	1 pc
4G memory card and holder	1 pc
White/black plate	1 pc
HDMI cable	1 pc
Power adapter	1 pc

OPTIONAL ACCESSORY

1X camera adapter	ISM-DL-CA1X
2X auxiliary objective	ISM-DL-OB2X
X-Y stage (travel: 2.91×2.36")	ISM-DL-STAGE

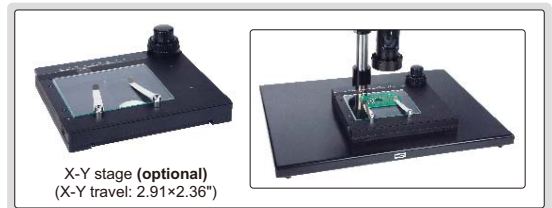

1X camera adapter (optional)



2X auxiliary objective (optional)

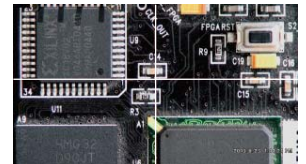

crosshair (white/black)

MAGNIFICATION, FOCUS DISTANCE AND VIEW FIELD

Auxiliary Objective	Specification	Camera adapter	
		0.5X (included)	1X (optional)
1X (included)	Magnification	18~112X	36~224X
	Focus distance	2.76±.08"	2.76±.08"
	View field	.5×.33~.08×.05"	.25×.17~.04×.03"
2X (optional)	Magnification	36~224X	72~448X
	Focus distance	1.14±.08"	1.14±.08"
	View field	.25×.17~.04×.03"	.13×.08~.02×.01"



## DIGITAL MEASURING MICROSCOPE (WITH DISPLAY)

BUILT-IN SOFTWARE WITHOUT COMPUTER

MEASUREMENT

TAKE PICTURES

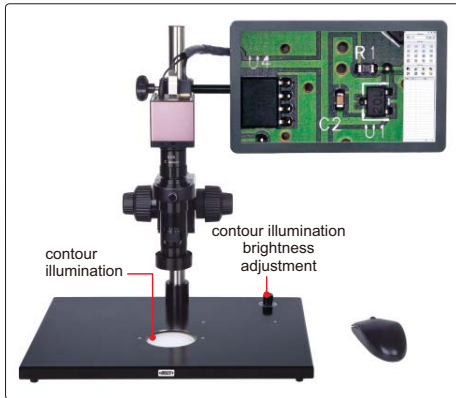

ISM-DL301-U (with contour illumination)

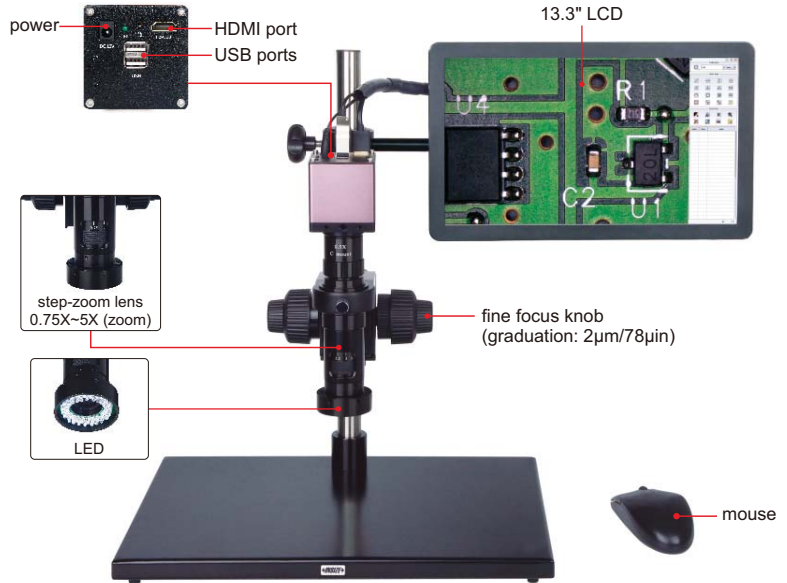

ISM-DL300 (without contour illumination)

- 1080P high-definition image
- Built-in software without computer, operation by mouse
- Take pictures, saved to USB flash disk
- Measurement results can be output to Excel
- Automatic white balance and exposure
- Brightness, contrast ratio, gain are adjustable

### SPECIFICATION

Part No.	ISM-DL300 (without contour illumination)	ISM-DL301-U (with contour illumination)
Magnification	15X~100X	
Sensor	1/2" CMOS	
Pixel	2M	
Resolution	1920×1080	
Frame rate	60fps	
Output	HDMI	
Power supply	power adapter	power adapter and 110V, 50/60Hz
Dimension (L×W×H)	22.44×11.81×16.93"	
Weight	14.44lb	

### STANDARD DELIVERY

Main unit	1 pc
0.5X camera adapter	1 pc
1X auxiliary objective	1 pc
Calibration plate	1 pc
16G USB flash disk	1 pc
White/black plate	1 pc
Mouse	1 pc
HDMI cable	1 pc
Power adapter	2 pc



calibration plate (included)



16G USB flash disk (included)



0.5X camera adapter (included)



1X auxiliary objective (included)



1X camera adapter (optional)



2X auxiliary objective (optional)

### OPTIONAL ACCESSORY

1X camera adapter	ISM-DL-CA1X
2X auxiliary objective	ISM-DL-OB2X
X-Y stage (travel: 2.91×2.36")	ISM-DL-STAGE

To be continued





Continued from previous page

### MAGNIFICATION, FOCUS DISTANCE AND VIEW FIELD

Auxiliary Objective	Specification	Camera adapter	
		0.5X (included)	1X (optional)
1X (included)	Magnification	15~100X	30~200X
	Focus distance	2.76±.08"	2.76±.08"
	View field	.63×.43~.1×.06"	.31×.21~.05×.03"
2X (optional)	Magnification	30~200X	60~400X
	Focus distance	1.14±.08"	1.14±.08"
	View field	.31×.21~.05×.03"	.15×.11~.024×.016"

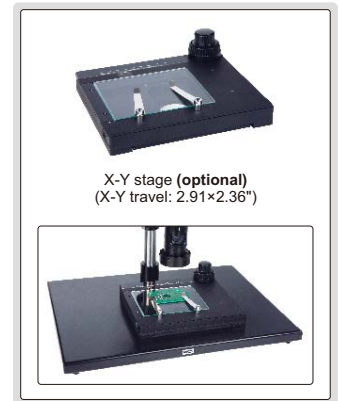

### MEASURING ACCURACY

Magnification	Measuring accuracy *
15X	±.00031"
30X	±.00024"
50X	±.00024"
80X	±.00016"
100X	±.00016"
>100X	±.00016"

\*When measuring the contour of workpieces, please select ISM-DL301-U to ensure accuracy.

### SOFTWARE

- Language: English
- Output to Excel
- Edge-detection:

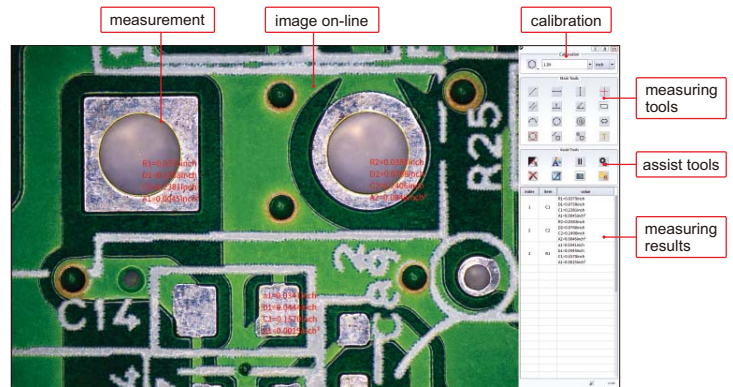
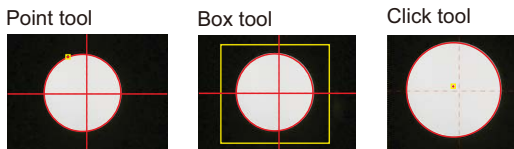

#### Measurement tools:

- |  |   |   |
|--|---|---|
| measure length of line or distance between two points                | measure length of line or distance between two points in horizontal direction | measure length of line or distance between two points in vertical direction |
| measure angle from horizontal line                                   | measure angle from vertical line  | measure angle of two lines  |
| measure distance between two parallel lines                          | measure distance between three parallel lines                                 | measure distance between multiple parallel lines                            |
| measure distance between point and line                              | measure radius, length and angle of arc                                       | measure girth and area of polygon   |
| measure radius, diameter, girth and area of circle with three points | measure radius, diameter, girth and area concentric of circles                | measure length, width, girth and area of rectangle                          |
| measure minimum distance between point and circle                    | measure distance between point and center of circle                           | measure maximum distance between point and circle                           |
| measure minimum distance between line and circle                     | measure distance between line and center of circle                            | measure maximum distance between line and circle                            |
| measure minimum distance between two circles                         | measure center distance between two circles                                   | measure maximum distance between two circles                                |
| add text   | measure radius, diameter, girth and area of circle with two points            | cross hair  |

# DIGITAL MEASURING MICROSCOPE

## PART NO. ISM-DM40

TAKE PICTURES AND VIDEOS

MEASUREMENT (ON COMPUTER)

FOCUS DISTANCE OF CAMERA IS ADJUSTABLE

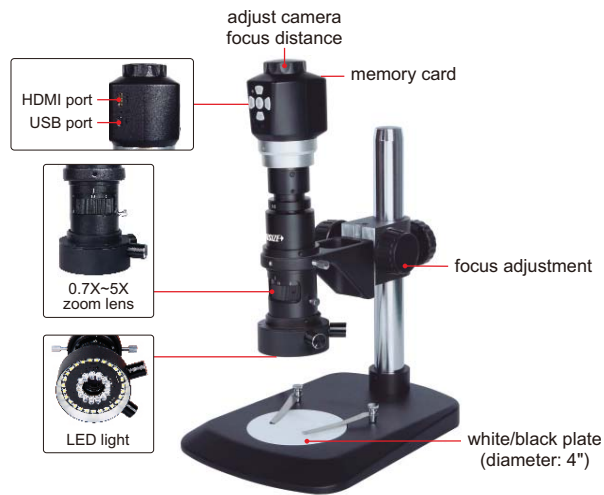
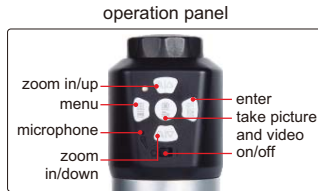
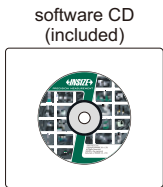

- Connected to TV and computer
- Take pictures and videos, saved to memory card
- Measurement on computer with accuracy  $\pm 0.0004''$
- Large working distance because focus distance of camera is adjustable
- Automatic white balance and exposure, white-black display mode
- Automatic power off

### SPECIFICATION

Magnification	15X~205X (on 19" monitor)	
Pixel	1.3M	
Sensor	1/3" CMOS	
Resolution	HDMI output	1920×1080, 1280×720, 640×480
	picture	2304×1536, 2304×1296, 1920×1080, 1280×720, 800×480
	video	1920×1080, 1280×720, 800×480
Output	USB/HDMI	
Power supply	5V (>500mA)	
Dimension (L×W×H)	10.75×8.07×12.2"	
Weight	7.78lb	

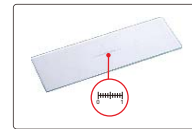

glass calibration rule (included, graduation 0.1mm/.004")

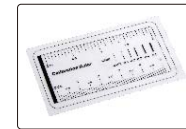

plastic calibration rule (included, graduation 1mm/.039")



8G memory card and holder (included)

### LENS SCALE, MAGNIFICATION AND FOCUS DISTANCE

Lens scale	Magnification (on 19" monitor)	Focus distance
0.7X	15~40X	.94~9.92"
1X	30~50X	1.06~6.1"
2X	70~80X	3.19~4.61"
3X	110~120X	3.7~4.37"
4X	140~160X	3.97~4.33"
5X	180~205X	4.05~4.29"

### MAGNIFICATION, VIEW FIELD AND FOCUS DISTANCE

Magnification (on 19" monitor)	View field	Focus distance
15X	1.1×.63"	9.92"
30X	.53×.32"	6.1"
50X	.31×.19"	4.88"
100X	.16×.09"	4.33"
150X	.11×.06"	4.25"
200X	.08×.05"	4.13"

16

### STANDARD DELIVERY

Main unit	1 pc
8G memory card and holder	1 pc
HDMI cable (for TV)	1 pc
USB cable and software (for computer)	1 pc
Plastic calibration rule (graduation 1mm/.039")	1 pc
Glass calibration rule (graduation 0.1mm/.004")	1 pc

### OPTIONAL ACCESSORY

Measuring stage	ISM-DM40-STAGE
-----------------	----------------

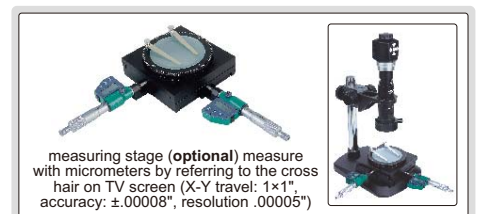
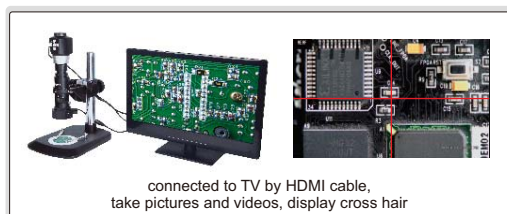

To be continued

Continued from previous page

## SOFTWARE FOR COMPUTER

- **Language:** Chinese, English, Japanese, German, French
- **Operation system:** Windows XP/7/8/10
- **Measurement tools:**

- measure length of continuous line
- measure radius, length and angle of arc
- measure angle with three points
- measure distance between two circles
- measure distance between point and line
- measure angle with two lines
- measure radius, girth and area of circle
- measure length of line or distance between two points
- measure distance between two parallel lines
- measure length, width, girth and area of rectangle
- measure center distance between parallel lines
- measure axis lengths, girth and area of ellipse
- measure circumference and area of polygon

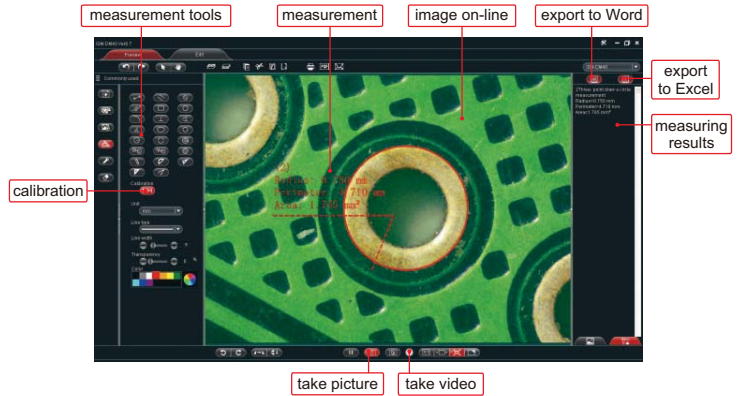

- **Comparison tools:**  
Create rule, angle or protractor, to compare with workpieces.

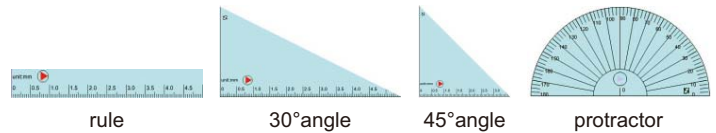

- **Data export to Word or Excel:**

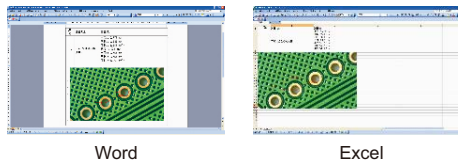

## DIGITAL MEASURING MICROSCOPES

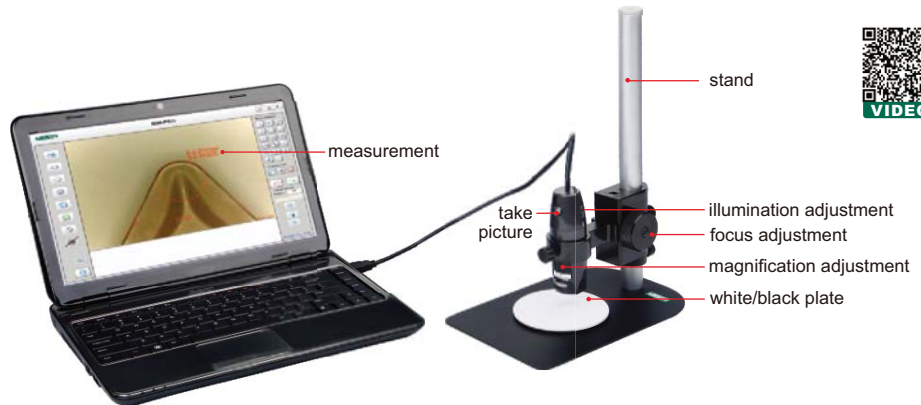
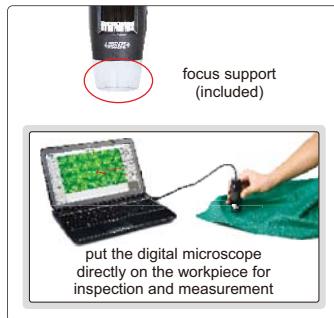

- Can take pictures and videos
- Supplied with software

**ISM-PM200SA**  
computer is not included

### SPECIFICATION

Part No.	ISM-PM200SA	ISM-PM200SB	ISM-PM600SA	ISM-PM160LA
<b>Magnification</b>	10X~200X	10X~200X	450X~600X	35X~160X
<b>Focus distance</b>	short focus distance	short focus distance	short focus distance	long focus distance
<b>Stand</b>	standard	universal	standard	standard
<b>Focus support</b>	included	included	not included	not included
<b>Calibration rule</b>	graduation 0.1mm/.004" and 1mm/.039"	graduation 0.1mm/.004" and 1mm/.039"	graduation 0.1mm/.004"	graduation 0.1mm/.004" and 1mm/.039"
<b>Pixel</b>	1.3M (resolution: 1280×1024)	2M (resolution: 1600×1200)		
<b>Illumination</b>	built-in adjustable LED			
<b>Power supply</b>	USB 2.0 cable (voltage required: 5±0.1V)			

To be continued

Continued from previous page

universal stand (included in ISM-PM200SB)



filter (optional)



software CD (included)



### OPTIONAL ACCESSORY

Green filter	ISM-PM-GREEN
Yellow filter	ISM-PM-YELLOW
Blue filter	ISM-PM-BLUE

### MAGNIFICATION, FOCUS DISTANCE, VIEW FIELD AND ACCURACY

ISM-PM200SA/ISM-PM200SB			
Magnification	Focus distance	View field	Accuracy
50X	.83"	.32×.25"	1.2mil
100X	.51"	.15×.12"	0.6mil
150X	.63"	.10×.08"	0.4mil
200X	.75"	.07×.06"	0.3mil

ISM-PM600SA			
Magnification	Focus distance	View field	Accuracy
450X	.06"	.03×.03"	.24mil
500X	.22"	.03×.02"	.24mil
550X	.34"	.03×.02"	.20mil
600X	.45"	.02×.02"	.20mil

ISM-PM160LA			
Magnification	Focus distance	View field	Accuracy
50X	2.44"	.32×.25"	1.2mil
100X	1.77"	.15×.12"	0.6mil
160X	1.97"	.09×.07"	0.4mil

### SOFTWARE

- **Language:** English, Japanese, Korean, German, Turkey, Portuguese, Chinese
- **Operation system:** Windows XP/7/8/10/Vista
- **Measuring tools:**
  - measure length of line or distance between two points
  - measure radius, length and angle of arc
  - measure distance between two parallel lines
  - measure distance between two circles
  - measure distance between point and line
  - measure length of continuous line
  - measure angle with three points
  - measure radius, girth and area of circle
  - measure area of rectangle
  - measure angle with two lines
  - add number with circle
  - add text

### Data export to CAD or Excel:

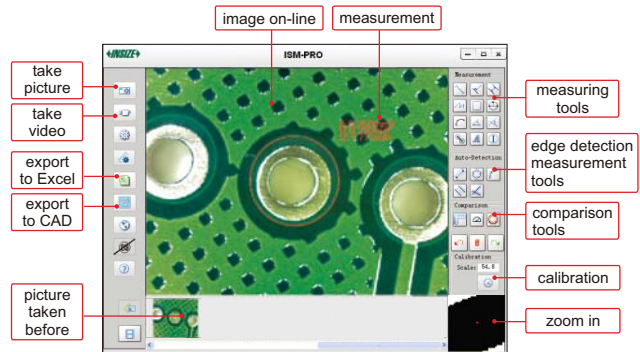
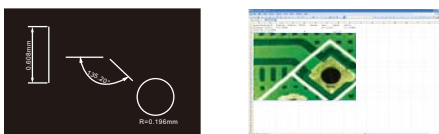

### Edge detection measurement tools:

- detect two parallel lines automatically and calculate distance
- detect circle automatically, and calculate radius, girth and area
- detect arc automatically, and calculate radius, angle and arc length
- detect line automatically, and calculate length
- detect two lines automatically, and calculate angle

### Comparison tools:

Create line, angle or circle with desired size, to compare with workpieces

- create line
- create angle
- create circle with tolerance

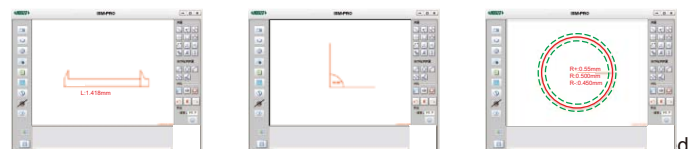



## WiFi DIGITAL MEASURING MICROSCOPE PART NO. ISM-WF200

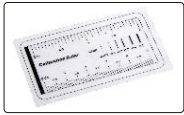

plastic calibration rule  
(included,  
graduation 1mm/.039")

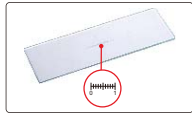

glass calibration rule  
(included,  
graduation 0.1mm/.004")



VIDEO

- Maximum working distance is 200" under WiFi mode
- Can be connected to multiple iPads, Android devices or computers at the same time under WiFi mode
- Take pictures and videos
- Supplied with software

### SPECIFICATION

Magnification	10X~200X
Pixel	1.3M (resolution: 1280×1024)
Illumination	built-in adjustable LED
Power supply	built-in rechargeable battery

### STANDARD DELIVERY

Microscope	1 pc
Base support	1 pc
Focus support ring for 80X/150X	1 pc
Focus support ring for 60X/200X	1 pc
Glass calibration rule (graduation 0.1mm/.004")	1 pc
Plastic calibration rule (graduation 1mm/.039")	1 pc
USB cable and software	1 pc
AC/DC adapter	1 pc

### OPTIONAL ACCESSORY

Stand	ISM-PM-STAND
Green filter	ISM-PM-GREEN
Yellow filter	ISM-PM-YELLOW
Blue filter	ISM-PM-BLUE

stand (part no.  
ISM-PM-STAND,  
optional)



filter (optional)



connected to iPad by WiFi



connected to Android device by WiFi



connected to computer by WiFi

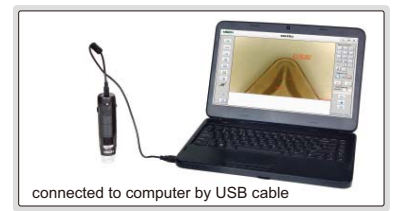

connected to computer by USB cable

### MAGNIFICATION, FOCUS DISTANCE, VIEW FIELD AND ACCURACY

Magnification	Focus distance	View field	Accuracy
50X	.83"	.32×.25"	1.2mil
100X	.51"	.15×.12"	0.6mil
150X	.63"	.10×.08"	0.4mil
200X	.75"	.07×.06"	0.3mil



software CD  
(included)

### 1 Software ISM-PAD (for iPad by WiFi)

- measure length of line or distance between two points
- measure angle
- measure radius, girth and area of circle with three points

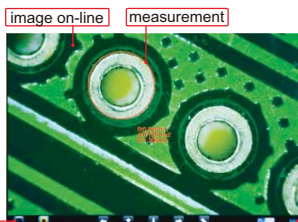

take picture and video, image on-line, measurement, resolution setting, picture taken before, move measuring point, take picture/video switch, measuring tools and calibration

### 2 Software ISM-APK (for Android devices by WiFi)

- measure length of line or distance between two points
- measure angle
- measure radius, girth and area of circle with three points

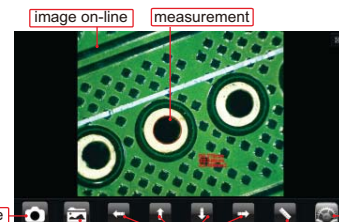

take picture, image on-line, measurement, resolution setting, picture taken before, move measuring point, measuring tools and calibration

### 3 Software ISM-WF Partner (for computer by WiFi)

- measure length of line or distance between two points
- measure area of polygon
- measure angle with three points
- measure radius, girth and area of circle with center point
- measure length of continuous line
- measure radius, girth and area of circle with three points
- measure angle with two lines
- measure radius, girth and area of circle with two points
- measure distance between point and line
- measure radius, length and angle of arc
- measure area of rectangle

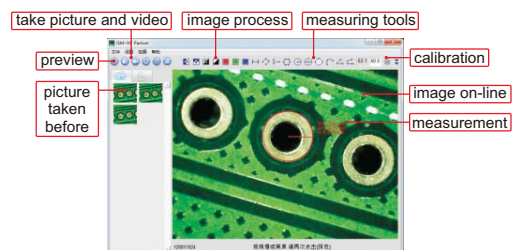

take picture and video, image process, measuring tools, preview, picture taken before, calibration, image on-line, measurement

To be continued



Continued from previous page

## 4 Software ISM-PRO (for computer by USB cable)

### Measuring tools:

- measure length of line or distance between two points
- measure length of continuous line
- measure radius, length and angle of arc
- measure distance between two circles
- measure distance between two parallel lines
- measure radius, girth and area of circle
- measure distance between point and line
- measure area of rectangle
- measure angle with three points
- add text
- measure angle with two lines
- add number with circle

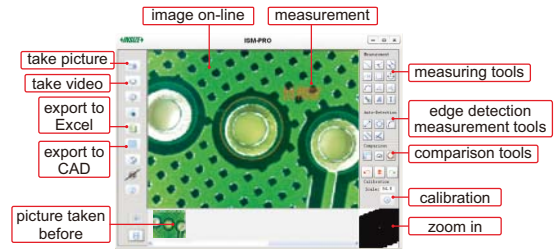

### Edge detection measurement tools:

- detect line automatically, and calculate length
- detect circle automatically, and calculate radius, girth and area
- detect arc automatically, and calculate radius, angle and arc length
- detect two parallel lines automatically, and calculate distance
- detect two lines automatically, and calculate angle

### Comparison tools:

Create line, angle or circle with desired size, to compare with workpieces

- create line
- create angle
- create circle with tolerance

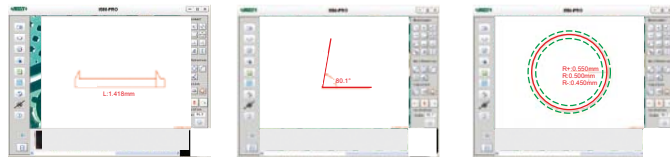

### Data export to CAD or Excel:

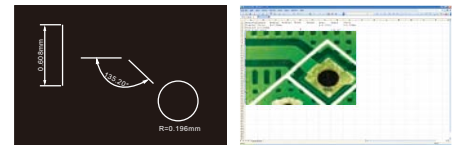

## TV DIGITAL MICROSCOPES

stand (part no. ISM-PM-STAND, optional)



- Connected to TV directly
- For observation, cannot take pictures and videos



ISM-TV200 (with wire)



ISM-TV200W (wireless)

ATTENTION: NOT FOR MEASUREMENT, NOT SUITABLE FOR COMPUTERS



### SPECIFICATION

Part No.	ISM-TV200	ISM-TV200W
Type	with wire	wireless (maximum transmission distance 200")
Magnification	10X~200X (on 17" TV)	
Pixel	0.35M	
Illumination	adjustable brightness LED	
Focus	supplied with focus ring, stand (ISM-PM-STAND) is optional	
Power supply	DC	built-in rechargeable battery

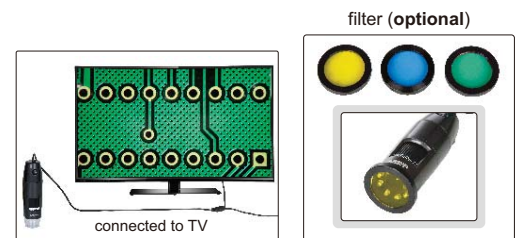

### MAGNIFICATION, FOCUS DISTANCE AND VIEW FIELD

ISM-TV200			ISM-TV200W		
Magnification	Focus distance	View field	Magnification	Focus distance	View field
50X	.83"	.32×.25"	60X	.75"	.27×.20"
100X	.51"	.15×.12"	80X	.63"	.20×.15"
150X	.63"	.10×.08"	150X	.63"	.10×.08"
200X	.75"	.07×.06"	200X	.75"	.07×.06"

### OPTIONAL ACCESSORY

Green filter	ISM-PM-GREEN
Yellow filter	ISM-PM-YELLOW
Blue filter	ISM-PM-BLUE

## METALLURGICAL MICROSCOPE PART NO. ISM-M2000



adapter 0.5X  
(included)

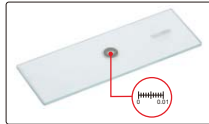

glass calibration rule (included,  
graduation 0.01mm/.0004")

- For high magnification observation and metallurgical image analysis
- Infinite optical system, can add optical accessories like polarizer, analyzer, DIC (part no. **ISM-M2000-DIC**) into optical path without image quality influence
- Objective can be used in both bright field and dark field
- Kohler illumination system provides uniform illumination field
- Three working modes: 100% eyepiece observation, 100% camera observation, both eyepiece and camera observation (80% illuminance for camera and 20% illuminance for eyepiece)



### SPECIFICATION

<b>Eyepiece (wide field)</b>	10X (view field .87" DIA)				
<b>Objective (plan achromatic)</b>	5X (included)	10X (included)	20X (included)	50X (included)	100X (included)
<b>Numerical aperture</b>	0.12	0.25	0.40	0.75	0.90
<b>Working distance</b>	.39"	.39"	.20"	.05"	.03"
<b>Stage</b>	double layer, size: 6.30×5.51", travel: 2.95×1.97" (graduation .004"/0.1mm)				
<b>Kohler illumination</b>	12V/50W halogen lamp, brightness is adjustable with polarizer and analyzer, built-in green, yellow, blue, gray and frosted glass				
<b>Pupil distance</b>	1.89~2.95"				
<b>Diopter adjustment</b>	±5 diopter (two eyepieces)				
<b>Power supply</b>	110/220V, 50/60Hz				
<b>Dimension (L×W×H)</b>	25.47×10.55×14.80"				
<b>Weight</b>	26.46lb				

### STANDARD DELIVERY

Main unit	1 pc
10X dividing eyepiece (graduation 0.1mm/.004")	1 pc
Calibration rule (graduation 0.01mm/.0004")	1 pc
Camera adapter	1 pc
Adapter 0.5X	1 pc
Anti-dust cover	1 pc

### OPTIONAL ACCESSORY

15X eyepiece (view field .63" DIA)	ISM-M2000-15X
20X eyepiece (view field .47" DIA)	ISM-M2000-20X
DIC	ISM-M2000-DIC

## ZOOM STEREO MICROSCOPES

### SPECIFICATION

Part No.	ISM-ZS50	ISM-ZS50T
<b>Optical tube</b>	binocular	trinocular
<b>Eyepiece (wide field)</b>	10X (view field .87" DIA)	
<b>Objective</b>	0.8X~5X (zoom)	
<b>Zoom ratio</b>	1:6.3	
<b>Pupil distance</b>	2.17~2.95" (adjustable)	
<b>Diopter adjustment</b>	±5 diopter (two eyepieces)	
<b>Working distance of objective</b>	4.53"	
<b>Max. workpiece height</b>	8.46"	
<b>Illumination</b>	adjustable reflected and transmitted LED light	
<b>Power supply</b>	110/220V, 50/60Hz	
<b>Dimension (L×W×H)</b>	11.42×10.24×18.90"	
<b>Weight</b>	10.80lb	



ISM-ZS50

### STANDARD DELIVERY

Main unit	1 pc
WF 10X eyepiece	2 pcs
3.94" DIA glass plate	1 pc
3.94" DIA white/black plate	1 pc
Anti-dust cover	1 pc

### OPTIONAL ACCESSORY

Auxiliary objective	0.5X	ISM-ZS50-OB05X
	2X	ISM-ZS50-OB2X
Eyepiece	10X dividing eyepiece (graduation 0.1mm/.004")	ISM-ZS50-EPD10X
	WF15X (view field .63" DIA)	ISM-ZS50-EP15X
	WF20X (view field .47" DIA)	ISM-ZS50-EP20X
Digital camera		ISM-D500

## ZOOM STEREO MICROSCOPE PART NO. ISM-ZS30

### SPECIFICATION

Optical tube	binocular
Eyepiece (wide field)	10X (view field .8" DIA)
Objective	1X~4.5X (zoom)
Zoom ratio	1:4.5
Pupil distance	2.17~2.95" (adjustable)
Diopter adjustment	±5 diopter (two eyepieces)
Working distance of objective	3.82"
Max. workpiece height	5.79"
Illumination	adjustable reflected and transmitted LED light
Power supply	110/220V, 50/60Hz
Dimension (L×W×H)	10.24×7.48×15.75"
Weight	9.48lb

### OPTIONAL ACCESSORY

Auxiliary objective	0.5X	ISM-ZS30-OB05X
	0.63X	ISM-ZS30-OB06X
	0.75X	ISM-ZS30-OB07X
	2X	ISM-ZS30-OB2X
Eyepiece	10X dividing eyepiece (graduation 0.1mm/.004")	ISM-ZS30-EPD10X
	WF15X (view field .63" DIA)	ISM-ZS50-EP15X
	WF20X (view field .47" DIA)	ISM-ZS50-EP20X
Digital camera		ISM-D500



### STANDARD DELIVERY

Main unit	1 pc
WF 10X eyepiece	2 pcs
3.74" DIA glass plate	1 pc
3.74" DIA white/black plate	1 pc
Anti-dust cover	1 pc

## HIGH MAGNIFICATION MICROSCOPE PART NO. ISM-M600-U\*\*

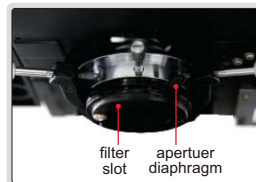
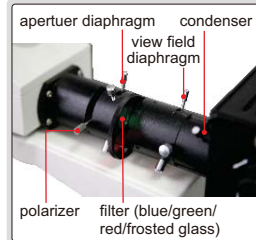

- For high magnification observation
- Reflected and transmitted illumination can work at the same time
- Objectives 40X, 60X are spring type

### SPECIFICATION

Eyepiece (wide field)	10X (view field .71" DIA)				
Objective (plan achromatic)	5X	10X	20X	40X	60X
Numerical aperture	0.12	0.25	0.40	0.60	0.75
Working distance	.72"	.35"	.34"	.15"	.05"
Stage	double layer with sample clamp size: 6.30×5.51" travel: 2.95×1.97" (graduation .004"/0.1mm)				
Pupil distance	2.09~2.95"				
Diopter adjustment	±5 diopter (one eyepiece)				
Illumination	reflected and transmitted: 6V/20W halogen lamp, brightness is adjustable				
Power supply	110V, 50/60Hz **				
Dimension (L×W×H)	17.72×11.81×13.78"				
Weight	24.25lb				

### STANDARD DELIVERY

Main unit	1 pc
Anti-dust cover	1 pc
Filter (blue/green/red/frosted glass)	1 pc of each

### OPTIONAL ACCESSORY

Objective	PL80X	ISM-MTM-OB80X
	PL100X (dry type)	ISM-MTM-OB100X
10X dividing eyepiece (graduation 0.1mm/.004")		ISM-MTM-EPD10X
WF16X eyepiece		ISM-MTM-EP16X
WF20X eyepiece		ISM-MTM-EP20X
Camera adapter (1X)		ISM-M600-ADAPTER
Digital camera		ISM-D500

## HIGH MAGNIFICATION MICROSCOPE PART NO. ISM-M1000-U\*\*

- For high magnification observation
- Kohler illumination system provides uniform illumination field
- Objectives 20X, 40X, 100X are spring type

### STANDARD DELIVERY

Main unit	1 pc
Oil for 100X objective	1 bottle
Anti-dust cover	1 pc
Filter (blue/green/yellow)	1 pc of each

### SPECIFICATION

Eyeiece (wide field)	10X (view field .71" DIA)			
Objective (plan achromatic)	10X	20X	40X	100X (oil type)
Numerical aperture	0.25	0.40	0.60	1.25
Working distance	.35"	.34"	.13"	.01"
Stage	double layer			
	size: 7.09×5.91"			
	travel .59×.59"			
Pupil distance	2.09~2.95"			
Diopter adjustment	±5 diopter (one eyepiece)			
Illumination	6V/20W halogen lamp			
Power supply	110V, 50/60Hz **			
Dimension (L×W×H)	15.16×11.81×17.32"			
Weight	24.25lb			

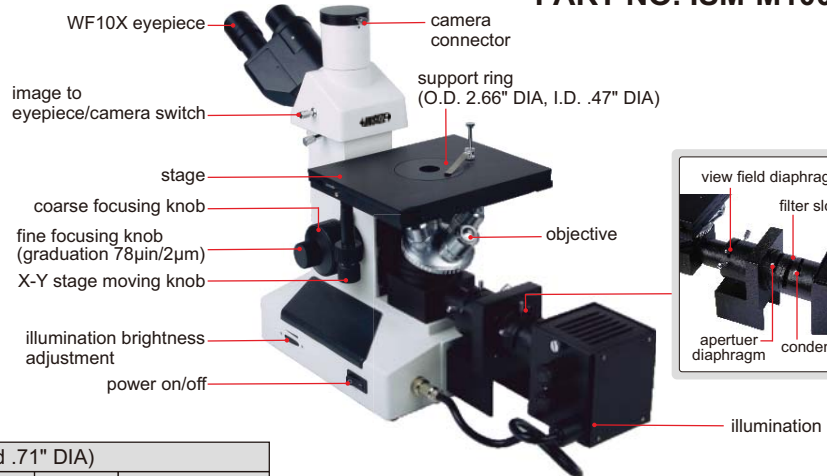

### OPTIONAL ACCESSORY

Objective	PL50X	ISM-MTM-OB50X
	PL60X	ISM-MTM-OB60X
	PL80X	ISM-MTM-OB80X
	PL100X (dry type)	ISM-MTM-OB100X
10X dividing eyepiece (graduation 0.1mm/.004")		ISM-MTM-EPD10X
WF16X eyepiece		ISM-MTM-EP16X
WF20X eyepiece		ISM-MTM-EP20X
Camera adapter (1X)		ISM-M1000-ADAPTER
Digital camera		ISM-D500

- Inserted into eyepiece tube or camera connector of microscopes
- Supplied with software

### SPECIFICATION

Sensor	1/2.5" CMOS
Pixel	5M
Resolution	2592×1944 or 1296×972
Frame rate	3fps (2592×1944)
	12fps (1296×972)
Exposure	manual or auto, exposure time is adjustable
SNR	41dB
Power supply	USB
Weight	.88lb

### STANDARD DELIVERY

Main unit	1 pc
Adapter 0.45X	1 pc
Calibration rule (graduation 0.1mm/.004")	1 pc
Connector .91" DIA/1.18" DIA	1 pc
USB cable	1 pc
Software disc	1 pc

### SOFTWARE FOR DIGITAL CAMERA (INCLUDED)

- measure distance between two points
- measure angle with three points
- measure circle
- measure rectangle
- calibration



## DIGITAL CAMERA PART NO. ISM-D500

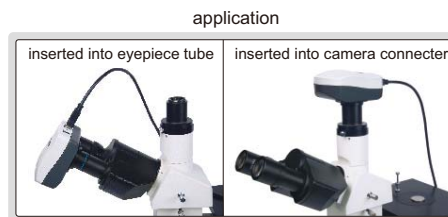

### OPTIONAL ACCESSORY

Connector .91" DIA/1.20" DIA	ISM-DCA-CON
------------------------------	-------------



software CD (included)



connector .91" DIA/1.18" DIA (included)

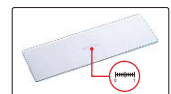

calibration rule (included, graduation 0.1mm/.004")



- Can take pictures and videos
- Exposure/gain/gamma/saturation/colour adjustment
- Image process feature: zoom in/out, image flip and so on



## PORTABLE MEASURING MICROSCOPES

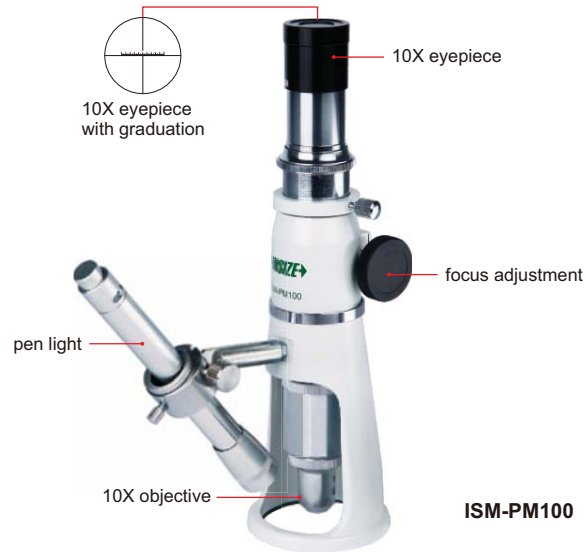

ISM-PM100

### SPECIFICATION

Part No.	ISM-PM20	ISM-PM40	ISM-PM50	ISM-PM100
Total magnification	20X	40X	50X	100X
Eyepiece	10X with graduation			
Objective (achromatic)	2X (numerical aperture: 0.05)	4X (numerical aperture: 0.1)	5X (numerical aperture: 0.12)	10X (numerical aperture: 0.25)
Working distance	.68"	.71"	.69"	.28"
Graduation	.002"/0.05mm	.001"/0.025mm	.0008"/0.02mm	.0004"/0.01mm
Viewing field	.35" DIA	.18" DIA	.14" DIA	.07"
Focus range	1.18" DIA			
Illumination	LED light			
Diameter of base	2.48" DIA			
Height	8.27"			
Weight	1.43lb			

### STANDARD DELIVERY

Main unit	1 pc
Pen light	1 pc
Battery (AAA)	2 pcs

## FOLDING MAGNIFIER

16

- Glass lens



7511-8

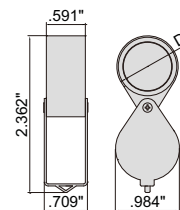

Part No.	Magnification	Lens diameter (D)
7511-8	8X	.827" DIA

## FOLDING MAGNIFIER WITH ILLUMINATION



2 pcs LED



7515-10

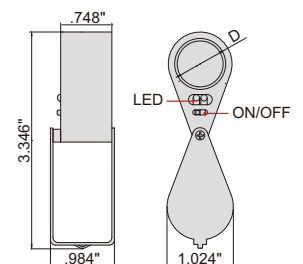

- Glass lens
- Powered by 3xLR927 batteries (included)

Part No.	Magnification	Lens diameter (D)
7515-10	10X	.867" DIA

## FOLDING MAGNIFIER WITH ILLUMINATION

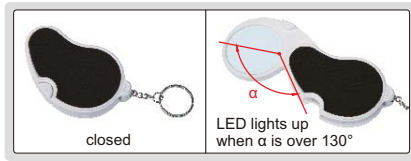

7514-1

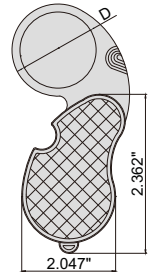

- Plastic lens
- Powered by 2xCR1620 batteries (included)
- LED lights up automatically when  $\alpha$  is over  $130^\circ$

Part No.	Magnification	Lens diameter (D)
7514-1	2.5X	1.772" DIA

## MAGNIFIERS WITH ILLUMINATION



7513-2



7513-4

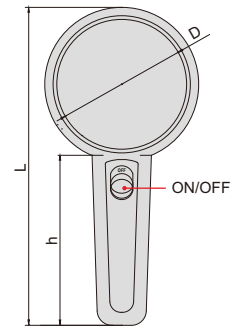

- Glass lens
- Powered by 3xAAA batteries (included)

Part No.	Magnification	Lens diameter (D)	L	h
7513-2	2X	2.953" DIA	6.693"	3.543"
7513-4	4X	1.969" DIA	5.709"	3.543"



## THREE WAYS MAGNIFIER WITH ILLUMINATION

- Plastic lens
- Powered by 2xAA batteries (included) or power adapter (110~240V, 50~60Hz)



three ways use



7512-1

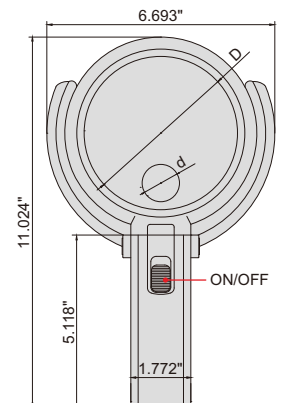
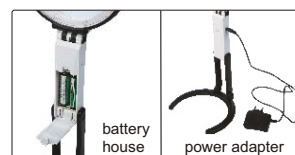

Part No.	Magnification	Lens diameter (D)	Lens diameter (d)
7512-1	2X/4X	4.724" DIA	1.102" DIA

## TABLE MAGNIFIER WITH ILLUMINATION PART NO. 7516-5D-U

- LED illumination, working life 20000h

### SPECIFICATION

Magnification	2.25X
Diopter	5D
Lens diameter	4.803" DIA
Illumination	power: 7W, illuminance: 420lm
Power supply	100~240V, 50~60Hz



## MOTORIZED 360° SWIVEL VIDEOSCOPIES

- Motorized joystick to bend the probe at any direction

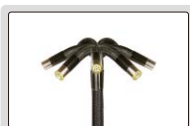

bend in any direction

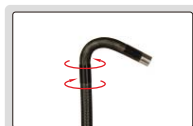

360° swivel in clockwise and counter-clockwise



bend within  $\pm 120^\circ$

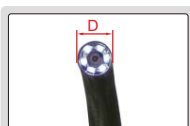

lens with LED adjustable illumination

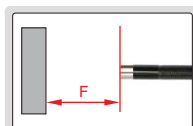

focus distance

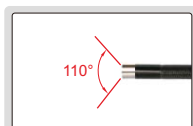

angle of view: 110°



TUNGSTEN WIRE WEAVED CABLE  
RESISTANCE TO BREAK AND WEAR

IP65  
WATERPROOF

ISV-4000D

### SPECIFICATION

Part No.	ISV-4000D	ISV-4001D	ISV-5000D	ISV-5001D	
Lens	diameter (D)	.26"		.18"	
	focus distance (F)	.6"~∞		.3~3.2"	
	illumination	6 pcs LED		6 pcs LED	
	pixel	0.41M			
	resolution	720×576			
	dust/waterproof	IP65			
	bend control	motorized joystick			
Cable	length	60"	120"	60"	
	type	tungsten wire weaved cable			
Main unit	function	take picture, take video			
	file format	picture: JPG, video: AVI			
	image process	brightness, image quality zoom (1X, 2X, 3X)			
	memory	8G SD card			
	output	TV, USB			
Weight	power supply	rechargeable battery (for 4 hours working) AC/DC adapter (for continuous working)			
		2.21lb	2.66lb	2.11lb	2.44lb



### STANDARD DELIVERY

Main unit	1 pc
Cable with lens	1 pc
8G SD card	1 pc
AC/DC adapter	1 pc
Video output cable	1 pc
USB cable	1 pc

**IP65**  
WATERPROOF



## MANUAL 360° SWIVEL VIDEOSCOPIES

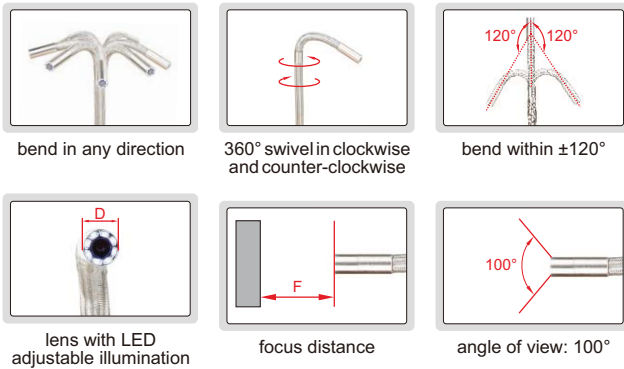

ISV-2000D

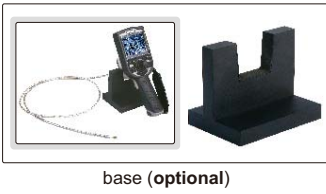

base (optional)

### STANDARD DELIVERY

Main unit	1 pc
Cable with lens	1 pc
8G SD card	1 pc
AC/DC adapter	1 pc
Video output cable	1 pc
USB cable	1 pc

### OPTIONAL ACCESSORY

Base	ISV-2000D-BASE
------	----------------

### SPECIFICATION

Part No.	ISV-2002D	ISV-2000D	ISV-2001D	ISV-3002D	ISV-3000D	ISV-3001D	
Lens	diameter (D)	.26"		.18"			
	focus distance (F)	.6"~∞		.3~3.2"			
	illumination	8 pcs LED		6 pcs LED			
	pixel	0.3M					
	resolution	640x480					
	dust/waterproof	IP65					
	bend control	manual joystick					
Cable	length	40"	60"	120"	40"	60"	
	type	steel wire weaved cable					
Main unit	function	take picture, take video					
	file format	picture: JPG, video: AVI					
	image process	brightness, image quality zoom (1X, 2X, 3X, 4X, 5X)					
	memory	8G SD card					
	output	TV, USB					
power supply	rechargeable battery (for 2 hours working) AC/DC adapter (for continuous working)						
Weight	1.32lb	1.43lb	1.76lb	1.22lb	1.32lb	1.54lb	

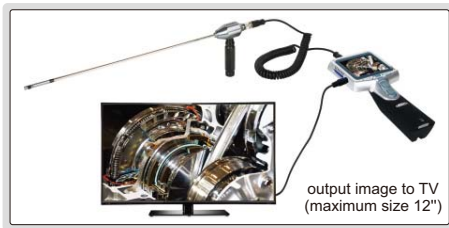

output image to TV (maximum size 12")



**IP57**  
WATERPROOF

## SIDE VIEW VIDEOSCOPE (RIGID) PART NO. ISV-RV



### SPECIFICATION

Diameter (D)	.22"
Length (L)	14"
Dust/waterproof probe	IP57
Pixel	0.3M
Resolution	640x480
Frame rate	30fps
Function	take picture, take video
File format	picture: JPG, video: AVI
Memory	2G SD card
Output	TV, USB
Power supply	rechargeable battery (for 3 hours working)
Weight	1.26lb



to observe internal wall of holes (minimum diameter .39" DIA)

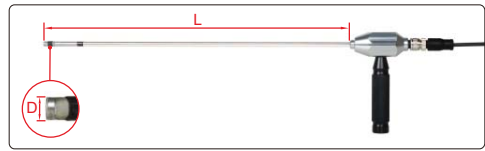
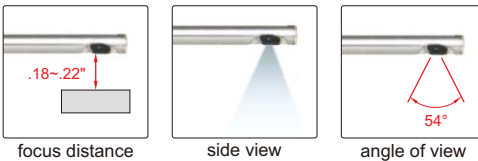

### STANDARD DELIVERY

Main unit	1 pc
2G SD card	1 pc
AC/DC adapter	1 pc
Video output cable	1 pc
USB cable	1 pc



## VIDEOSCOPE PART NO. ISV-E10



**IP65**  
WATERPROOF

**OPTIONAL CABLE**  
LENGTH 3M, 5M AND 10M

**ATTENTION: THE CABLE CAN BE BENT**  
**BUT CAN'T BE SET AT A FIXED SHAPE**

### SPECIFICATION

Lens	diameter	.22"
	pixel	0.3M
	resolution	640×480
	frame rate	30fps
Cable	length	40"
	type	steel wire weaved cable
Main unit	function	take picture, take video
	file format	picture: JPG, video: AVI
	image process	brightness, contrast, color saturation
	memory	2G SD card
	output	TV, USB
	power supply	rechargeable battery (for 3 hours working)
Weight	.99lb	

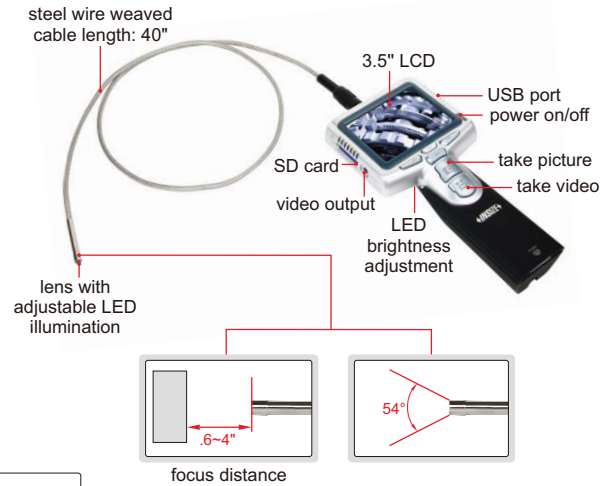

### STANDARD DELIVERY

Main unit	1 pc
Cable with lens	1 pc
2G SD card	1 pc
45° mirror	1 pc
AC/DC adapter	1 pc
Video output cable	1 pc
USB cable	1 pc
Lens cleaning kit	1 pc

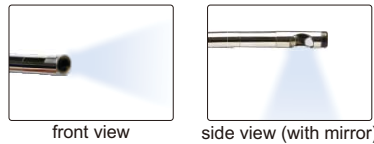

### OPTIONAL ACCESSORY

35° mirror	ISV-E55-M35
60° mirror	ISV-E55-M60

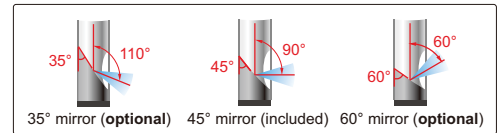

## VIDEOSCOPE PART NO. ISV-E20

**IP57**  
WATERPROOF

the cable has high illumination and can be set at any shape. it is suitable to observe large internal space like turbocharger.

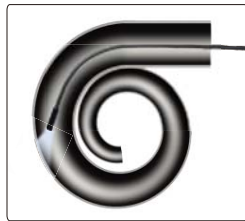

lens with 8 pcs LED adjustable illumination

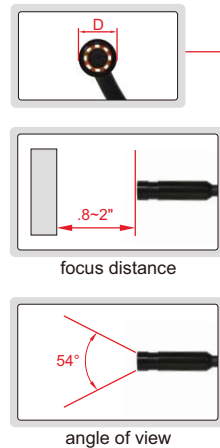

### SPECIFICATION

Lens	diameter (D)	.47"
	pixel	0.4M
	resolution	720×682
	frame rate	30fps
Cable	length	40"
	type	memory (can be set at any shape)
Main unit	function	take picture, take video
	file format	picture: JPG, video: AVI
	image process	brightness, contrast, color saturation
	memory	2G SD card
	output	TV, USB
	power supply	rechargeable battery (for 3 hours working)
Weight	1.32lb	

### STANDARD DELIVERY

Main unit	1 pc
Cable with lens	1 pc
2G SD card	1 pc
AC/DC adapter	1 pc
Video output cable	1 pc
USB cable	1 pc
Lens cleaning kit	1 pc



45° mirror (optional)



hook (optional)

### OPTIONAL ACCESSORY

45° mirror	ISV-E20-MIRROR
Hook	ISV-E20-HOOK
Magnet pick up	ISV-E20-MAGNET



magnet pick up (optional)

**ATTENTION: RESISTANCE TO ACID AND ALKALI LIQUID (CONSULT IS NEEDED)**

**IP68 WATERPROOF**

## PIPE VIDEOSCOPE PART NO. ISV-VP280

### SPECIFICATION

Lens	diameter	1.10"
	dust/waterproof	IP68
	pixel	0.3M
	resolution	640×480
Cable	frame	30fps
	length	72ft
	dust/waterproof	IP68
Main unit	type	semi-rigid
	function	take picture and video
	file format	picture: JPG, video: ASF
	image process	mirror, rotate, zoom (1.5X, 2X)
	memory	4G SD card
	output	TV, USB
	power supply	4×AA batteries
Weight	11.03lb	

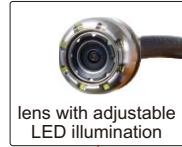

### STANDARD DELIVERY

Main unit	1 pc
Cable with lens	1 pc
Stand	1 pc
Indicator of cable working length	1 pc
4G SD card	1 pc
4" DIA brush	1 pc
AA battery	4 pcs
AAA battery	2 pcs
Video output cable	1 pc
USB cable	1 pc

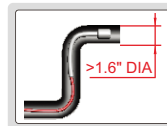
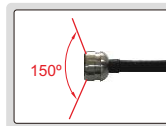
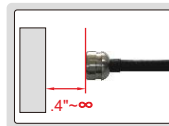

### OPTIONAL ACCESSORY

2" DIA centering ring	ISV-VP280-R50
6" DIA brush	ISV-VP280-B150

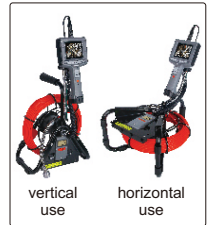

**IP67 WATERPROOF**

## RIGID BORESCOPIES



### ISV-1H4300

- Focus distance .08", depth of view .2~4"
- Dust/waterproof level: IP67
- Can be used in the liquid with temperature: 14°F~185°F

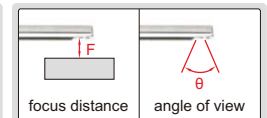
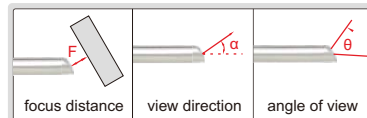
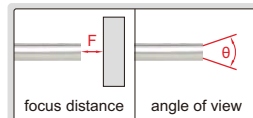

### SPECIFICATION

Part No.	Length (L)	View direction (α)	Diameter (D)	Angle of view (θ)
ISV-1H4170	6.85"	0°	.16"	≥60°
ISV-1H4173	6.85"	30°		
ISV-1H4177	6.85"	70°		
ISV-1H4179	6.54"	90°		
ISV-1H4300	11.89"	0°		
ISV-1H4303	11.89"	30°	.24"	≥70°
ISV-1H4307	11.89"	70°		
ISV-1H4309	11.69"	90°		

Part No.	Length (L)	View direction (α)	Diameter (D)	Angle of view (θ)
ISV-1H6200	8.23"	0°	.24"	≥70°
ISV-1H6203	8.23"	30°		
ISV-1H6207	8.23"	70°		
ISV-1H6209	6.54"	90°		
ISV-1H6320	12.91"	0°		
ISV-1H6323	12.91"	30°	.24"	≥70°
ISV-1H6327	12.91"	70°		
ISV-1H6329	12.99"	90°		

### OPTIONAL ACCESSORY

LED light handle	ISV-1HLED
Adjustable LED light source	ISV-1LED1
Camera	ISV-2CAM



## LED LIGHT HANDLE PART NO. ISV-1HLED

- For rigid borescopes (part no. ISV-1Hxx)



battery (included)

### SPECIFICATION

Power	3W
Battery	3.7V rechargeable battery (for 2 hours working)
Dimension	4.72×1.06×1.06"
Weight	.66lb

### STANDARD DELIVERY

Main unit	1 pc
Battery	1 pc
Charger	1 pc



charger (included)

## ADJUSTABLE LED LIGHT SOURCE PART NO. ISV-1LED1

- For rigid borescopes (part no. ISV-1Hxx)
- High LED illumination and brightness is adjustable
- For long time work with low noise



### SPECIFICATION

Color temperature	5600K
Cooling	fan cooling
Power	AC110~220V, 50/60Hz
Dimension	15.75×11.81×4.41"
Weight	15.44lb

### STANDARD DELIVERY

Main unit	1 pc
72" optical fiber cable	1 pc

## CAMERA (WITH DISPLAY) PART NO. ISV-2CAM

TAKE PICTURES

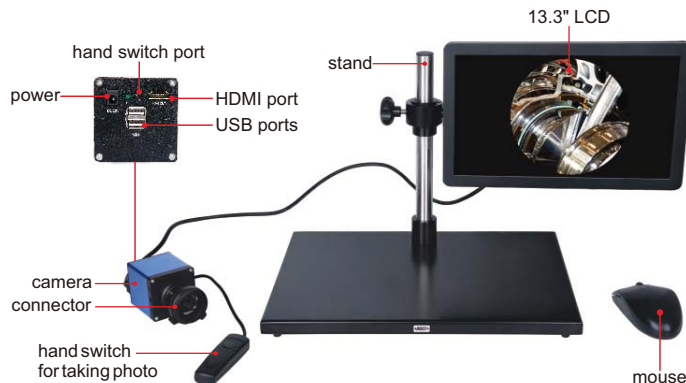

- For rigid borescopes (part no. ISV-1Hxx)
- 1080P high-definition image
- Take pictures, saved to USB flash disk
- Automatic white balance and exposure
- Brightness, contrast ratio, gain are adjustable
- Focus is adjustable

### SPECIFICATION

Sensor	1/2" CMOS
Pixel	2M
Resolution	1920×1080
Frame rate	60fps
Output	HDMI
Power supply	power adapter
Dimension (L×W×H)	22.44×11.81×11.02"
Weight	11.11lb

### STANDARD DELIVERY

Camera	1 pc
Connector	1 pc
Hand switch	1 pc
13.3" LCD	1 pc
Stand	1 pc
16G USB flash disk	1 pc
Mouse	1 pc
HDMI cable	1 pc
Power adapter	2 pcs



16G USB flash disk (included)

CAN BE CONTROLLED BY COMPUTER

DATA OUTPUT

## ROUGHNESS TESTER PART NO. ISR-C002

- 21 roughness parameters
- Display roughness values, profile and curve
- Memory of maximum 100 results
- Automatic power off



VIDEO



software CD (included)

### extension rod (optional), Part No. ISR-C002-ER



### transverse rod (optional), Part No. ISR-C002-TR



### small hole probe (optional), Part No. ISR-C002-SBP

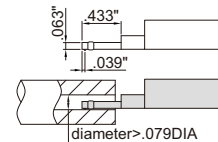

### deep groove probe (optional), Part No. ISR-C002-DGP

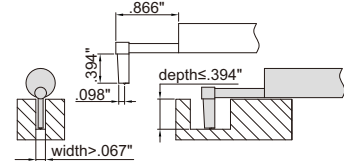

### light duty test stand (optional)



### heavy duty test stand (optional)



printer (optional)



probe cover (included)



adjustable stand (included)



software (included)

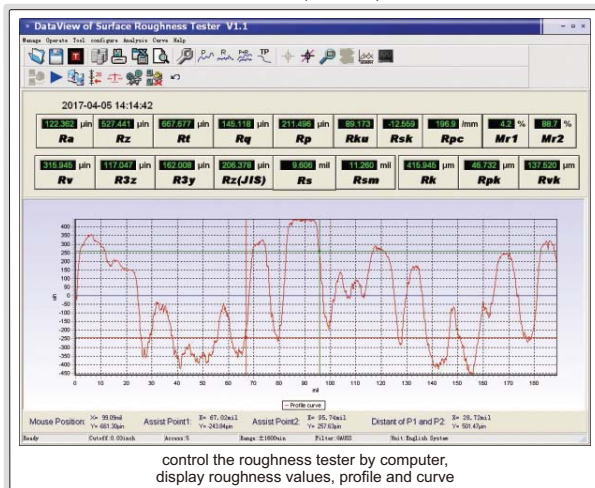

screen display

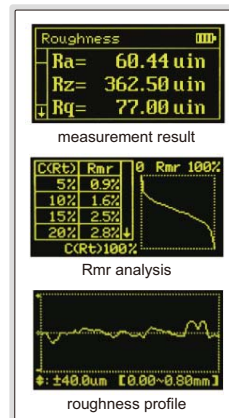

## SPECIFICATION

Parameters	Ra, Rz, Rq, Rv, Rp, RS, R3z, R3y, Rt, Rz (JIS), Rk, Rku, Rsm, Rpc, Rpk, Rvk, Rsk, Mr1, Mr2, Ry (JIS), Rmax	
Range	6299µm	
Accuracy	±10%	
Resolution (Ra)	0.01µm	
Probe	type	inductive
	stylus radius/angle	196µm/90°
	stylus material	diamond
Measuring force	.01ozf	
Measuring unit	µm/µin	
Cut off	.01/.03/.1"	
Number of cut-offs	1 to 5	
Traverse speed	.02"/s, .04"/s	
Memory	100 measurement results	
Output	USB	
Power	built-in rechargeable battery	
Dimension (L×W×H)	5.55×2.16×1.57"	
Weight	.89lb	

## STANDARD DELIVERY

Main unit	1 pc
Standard probe	1 pc
Calibration block and support	1 pc of each
Adjustable stand	1 pc
Probe cover	1 pc
Software	1 pc
AC/DC adapter	1 pc

## OPTIONAL ACCESSORY

Extension rod	ISR-C002-ER
Transverse rod	ISR-C002-TR
Deep groove probe	ISR-C002-DGP
Small hole probe	ISR-C002-SBP
Light duty test stand	ISR-C002-STAND1
Heavy duty test stand	ISR-C002-STAND
Printer	ISR-C002-PRINTER



# SURFACE ROUGHNESS TESTER PART NO. ISR-S1000B

**INSIZE PLUS**  
MADE IN ITALY



DATA  
OUTPUT

THE PROBE CAN BE WITH  
SKID OR WITHOUT SKID

CUSTOM-MADE PROBES  
ARE AVAILABLE

CAN MEASURE WAVINESS AND  
CURVED SURFACE WITH RADIUS>.197"

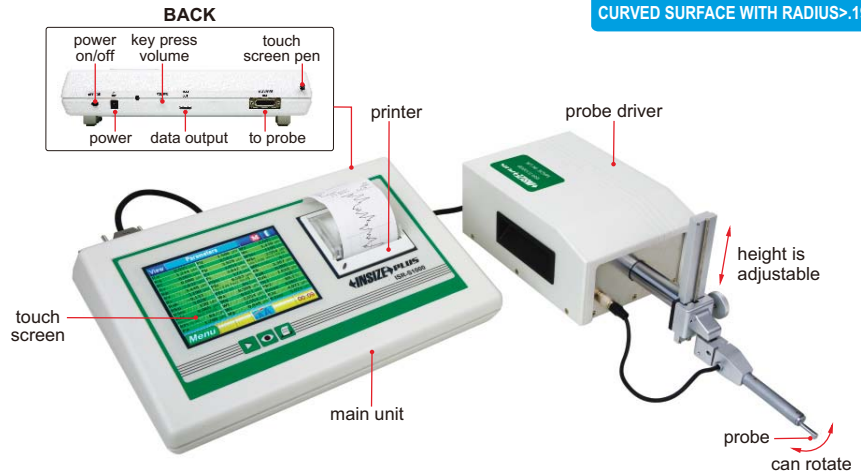

- 48 roughness parameters according to ISO-4287, JIS-B0601, ISO-12085, JIS-B0631
- Automatic probe leveling
- Measuring range up to 39370µm, can measure grit and shot blasting
- Traverse length up to 1.97"
- The probe can rotate from -90° to +90°
- Color touch screen, display roughness values, profile and curves
- Can print roughness values, profile and curves
- Memory of maximum 1000 results
- Can set tolerance

measuring software (optional)

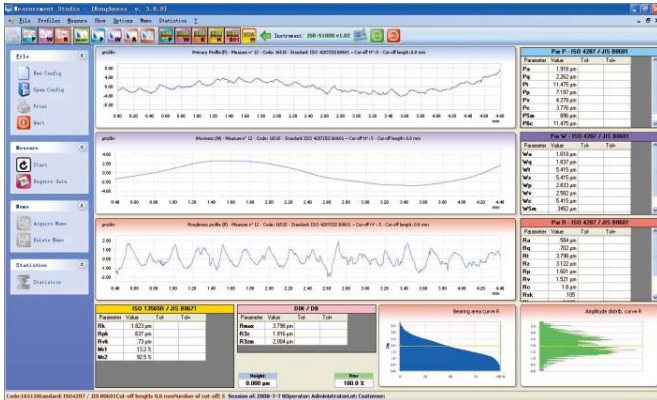

measuring software (optional), can control the roughness tester, display roughness values, profile and curve, data statistics

test stand (optional)

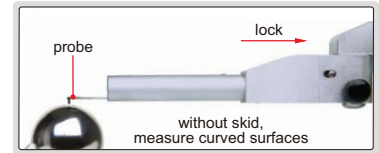
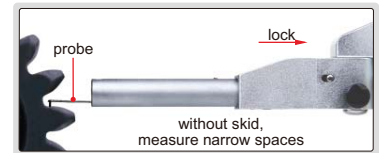
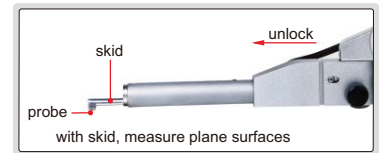

## SPECIFICATION

Parameters	Ra, Rq, Rt, Rz, Rp, Rv, Rc, Rsk, Rku, RSm, Rdc, RPa, Rq, Rp, Pv, Pc, Psm, Pdc, PpC, Wa, Wq, Wt, Wz, Wp, Wv, Wc, Wsm, Wdc, WpC, Rk, Rpk, Rvk, Mr1, Mr2, Rmax, R3z, R3zm, R, AR, Rx, Aw, Rke, Rpke, Rvke, Mr1e, Mr2e
Range	39370µm
Accuracy	±3%
Resolution (Ra)	.01µm
Probe	type: inductive stylus radius/angle: 196µm/90° stylus material: diamond
Measuring force	0.003ozf
Measuring unit	µm/µm
Cut off	.003/.01/.03/.1/.3"
Number of cut-offs	1-19 (cut off .003/.01/.03/.1") 1-5 (cut off .3")
Traverse speed	.02"/s or .04"/s
Memory	1000 measurement results
Output	USB
Power	built-in rechargeable battery
Dimension (LxWxH)	12.60x8.27x3.15"
Weight	4.85lb

## ROUGHNESS VALUE, PROFILE AND DATA ANALYSIS

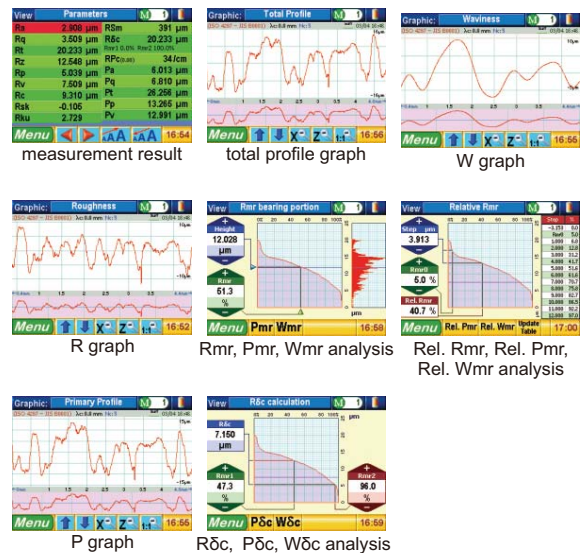

To be continued

Continued from previous page

**SURFACE ROUGHNESS TESTER  
PART NO. ISR-S1000B**

**STANDARD DELIVERY**

Main unit	1 pc
Probe driver	1 pc
Standard probe	1 pc
Calibration block	1 pc
AC/DC adapter	1 pc

**OPTIONAL ACCESSORY**

Probe	see details
USB cable and software	ISR-S-SOFTWARE
Test stand	ISR-S1000B-STAND

**SPECIFICATION OF PROBES**

<p><b>standard probe (included, skid is removable), part no. ISR-SB10B</b></p> <p>with skid, measure plane surfaces, holes and cylinders with diameter &gt;.394" DIA</p> <p>without skid, to measure holes with diameter &gt;.157" DIA, can measure curved surfaces, narrow spaces and waviness</p>		
<p><b>small hole probe (optional), part no. ISR-SB60B</b></p> <p>without skid, measure holes with diameter &gt;.079" DIA and depth &lt;1.181", can measure curved surfaces, narrow spaces and waviness</p>	<p><b>internal angle probe (optional), part no. ISR-SB70B</b></p> <p>without skid, measure internal angles, can measure curved surfaces, narrow spaces and waviness</p>	<p><b>knife edge probe (optional), part no. ISR-SB130B</b></p> <p>without skid, measure knife edges and small rods</p>
<p><b>deep groove probe (optional), part no. ISR-SB150B</b></p> <p>without skid, measure curved surfaces and grooves with depth &lt;.512", can measure curved surfaces, narrow spaces and waviness</p>		<p><b>deep groove probe (optional), part no. ISR-SB120B</b></p> <p>measure grooves with depth &lt;.787"</p>
<p><b>hole probe (optional), part no. ISR-SB30B</b></p> <p>measure plane surfaces and holes with diameter &gt;.157" DIA and depth &lt;.787"</p>	<p><b>small rod probe (optional), part no. ISR-SB40B</b></p> <p>measure small rods with diameter .039-.197" DIA</p>	<p><b>transverse probe (optional), part no. ISR-SB50B</b></p> <p>transverse measurement for plane surfaces, cylinders and grooves</p>
<p><b>deep hole probe (optional), part no. ISR-SB80B</b></p> <p>measure holes with diameter &gt;.177" DIA and depth &lt;1.378"</p>	<p><b>cylinder/hole probe (optional), part no. ISR-SB110B</b></p> <p>measure cylinders and holes with radius &gt;.197" R</p>	<p><b>groove probe (optional), part no. ISR-SB20B</b></p> <p>measure plane surfaces and grooves</p>

# ROUGHNESS TESTER PART NO. ISR-S400

**INSIZE PLUS**  
MADE IN ITALY



- Automatic probe leveling
- Language: English, French, German, Italian, Spanish, Portuguese
- 12 roughness parameters
- Can set tolerance
- Measuring range up to 15748µm, can measure grit and shot blasting
- Traverse length up to .63"
- The probe can be set at 90° or 270°, for transverse measurement
- Memory of maximum 100 results



measuring software (optional), can control the roughness tester, display roughness values, profile and curve, data statistics

PROBE CAN  
BE REPLACED

DATA  
OUTPUT

CUSTOM-MADE  
PROBES ARE AVAILABLE



software CD  
(included)



adjustable stand (included)



transverse measurement



probe cover (included), can put the small workpieces directly on the probe for measurement

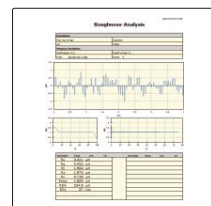

output software (included), output data and graphic to Excel, make report, print



heavy duty test stand (optional)



light duty test stand (optional)

## SPECIFICATION

Parameters	Ra, Rq, Rt, Rz, Rc, Rmax, Rsm, Rpc, Rmr, R, AR, Rx	
Range	Ra: 0~3937µm, Rt: 1.97~15748µm	
Accuracy	±3%	
Resolution (Ra)	.01µm	
Probe	type	inductive
	stylus radius/angle	196µm/90°
	stylus material	diamond
Measuring force	.003ozf	
Measuring unit	µm/µm	
Cut off	.01/.03/.1"	
Number of cut-offs	1 to 5	
Traverse speed	.04"/s	
Memory	100 measurement results	
Output	USB	
Power	built-in rechargeable battery	
Dimension (L×W×H)	4.80×2.05×2.68"	
Weight	1.43lb	

## STANDARD DELIVERY

Main unit	1 pc
Standard probe	1 pc
Calibration block	1 pc
Adjustable stand	1 pc
AC/DC adapter	1 pc
Probe cover	1 pc
USB cable and output software	1 pc

## OPTIONAL ACCESSORY

Extension rod	ISR-S400-ER100
Probe	see details
Measuring software	ISR-S-SOFTWARE
Heavy duty test stand	ISR-S400-DK
Light duty test stand	ISR-S400-STAND

To be continued

Continued from previous page

**ROUGHNESS TESTER  
PART NO. ISR-S400**

**SPECIFICATION OF PROBES**

<p><b>standard probe (included)</b></p> <p>measure plane surfaces, holes and cylinders with diameter &gt;.394" DIA</p>	<p><b>small roughness probe (optional), part no. ISR-S400-SB10R2</b></p> <p>measure surfaces with small roughness</p>
<p><b>extension rod (optional), part no. ISR-S400-ER100</b></p> <p>for long holes</p>	
<p><b>groove probe (optional), part no. ISR-S400-SB20</b></p> <p>measure plane surfaces and grooves</p>	<p><b>deep groove probe (optional), part no. ISR-S400-SB120</b></p> <p>measure grooves with depth &lt;.787"</p>
<p><b>small hole probe (optional), part no. ISR-S400-SB30</b></p> <p>measure plane surfaces and holes with diameter &gt;.157" DIA and depth &lt;.787"</p>	<p><b>deep hole probe (optional), part no. ISR-S400-SB80</b></p> <p>measure holes with diameter &gt;.177" DIA and depth &lt;1.378"</p>
<p><b>small rod probe (optional), part no. ISR-S400-SB40</b></p> <p>measure small rods with diameter .039-.197" DIA</p>	<p><b>cylinder/hole probe (optional), part no. ISR-S400-SB110</b></p> <p>measure cylinders and holes with radius &gt;.197" R</p>
<p><b>transverse probe (optional), part no. ISR-S400-SB50</b></p> <p>transverse measurement for plane surfaces, cylinders and grooves</p>	<p><b>internal angle probe (optional), part no. ISR-S400-SB140</b></p> <p>measure internal angles</p>



## ROUGHNESS TESTER PART NO. ISR-C003

- Unit:  $\mu\text{m}$ ,  $\mu\text{in}$
- Automatic power off

### SPECIFICATION

Parameters		Ra, Rz, Rq, Rt
Range		Ra, Rq: 2~590 $\mu\text{in}$ Rz, Rt: 4~1968 $\mu\text{in}$
Accuracy		$\pm 10\%$
Resolution (Ra)		0.01 $\mu\text{in}$
Probe	type	piezoelectric
	stylus radius/angle	393 $\mu\text{in}/90^\circ$
	stylus material	diamond
Measuring force		.012ozf
Measuring unit		$\mu\text{m}/\mu\text{in}$
Cut off		.01/.03/.1"
Evaluation length		.05" for cut off .01" .15" for cut off .03" .2" for cut off .1"
Traverse speed		.03"/s
Power		built-in rechargeable battery
Dimension (L×W×H)		4.17×2.75×.94"
Weight		.44lb



calibration block  
(included)

### STANDARD DELIVERY

Main unit	1 pc
Calibration block	1 pc
AC/DC adapter	1 pc

## SURFACE ROUGHNESS SPECIMEN SET PART NO. ISR-CS2E

ATTENTION: PLEASE APPLY  
ANTI-RUST OIL AFTER USE

- For checking, identifying and specifying the roughness by symbol
- Made of carbon steel



Machining method	Roughness (Ra)	Roughness (Rz)	Quantity
Horizontal milling	16, 32, 63, 125, 250, 500 $\mu\text{in}$	100, 160, 320, 640, 1280, 2000 $\mu\text{in}$	6 pcs
	0.4, 0.8, 1.6, 3.2, 6.3, 12.5 $\mu\text{m}$	1.6, 3.2, 6.3, 12.5, 25, 50 $\mu\text{m}$	
Vertical milling	16, 32, 63, 125, 250, 500 $\mu\text{in}$	100, 160, 320, 640, 1280, 2000 $\mu\text{in}$	6 pcs
	0.4, 0.8, 1.6, 3.2, 6.3, 12.5 $\mu\text{m}$	1.6, 3.2, 6.3, 12.5, 25, 50 $\mu\text{m}$	
Turning	16, 32, 63, 125, 250, 500 $\mu\text{in}$	100, 160, 320, 640, 1280, 2000 $\mu\text{in}$	6 pcs
	0.4, 0.8, 1.6, 3.2, 6.3, 12.5 $\mu\text{m}$	1.6, 3.2, 6.3, 12.5, 25, 50 $\mu\text{m}$	
Plain grinding	2, 4, 8, 16, 32, 63 $\mu\text{in}$	22.1, 40, 63, 120, 240, 400 $\mu\text{in}$	6 pcs
	0.05, 0.1, 0.2, 0.4, 0.8, 1.6 $\mu\text{m}$	0.2, 0.4, 0.8, 1.6, 3.2, 6.3 $\mu\text{m}$	
Flat lapping	2, 4 $\mu\text{in}$	22.1, 40 $\mu\text{in}$	2 pcs
	0.05, 0.1 $\mu\text{m}$	0.2, 0.4 $\mu\text{m}$	
External grinding	8, 16, 32, 63 $\mu\text{in}$	63, 120, 240, 400 $\mu\text{in}$	4 pcs
	0.2, 0.4, 0.8, 1.6 $\mu\text{m}$	0.8, 1.6, 3.2, 6.3 $\mu\text{m}$	

## SURFACE ROUGHNESS SPECIMENS

**INSIZE PLUS**  
MADE IN UK



- For checking, identifying and specifying the roughness by symbol
- Rust-proof, made of pure Nickel

ISR-CSE315

Part No.	Machining method	Roughness (Ra)	Roughness (Rz)	Quantity
ISR-CSE315	Surface grinding	1, 2, 4, 8, 16, 32, 63, 125µin	11.8, 22.1, 36.3, 69.6, 104, 186, 315, 625µin	8 pcs
ISR-CSE316	Cylindrical grinding	1, 2, 4, 8, 16, 32, 63, 125µin	11.9, 21.0, 35.2, 62.4, 106, 176, 309, 613µin	8 pcs
ISR-CSE317	Flat lapping	Criss-cross	1, 2, 4, 8µin	16, 24, 30, 50µin
		Parallel	1, 2, 4, 8µin	14, 22, 45, 60µin
ISR-CSE318	Cylindrical lapping	1, 2, 4, 8µin	18, 22, 25, 49µin	4 pcs
	Superfinishing	1, 2, 4, 8µin	14, 28, 40, 56µin	4 pcs
ISR-CSE319	Face turning	16, 32, 63, 125, 250, 500, 1000, 2000µin	76.8, 128, 246, 500, 950, 1950, 4010, 7400µin	8 pcs
ISR-CSE320	Cylindrical turning	16, 32, 63, 125, 250, 500, 1000, 2000µin	68, 128, 244, 488, 950, 1900, 3800, 7600µin	8 pcs
ISR-CSE321	End milling	16, 32, 63, 125, 250, 500, 1000, 2000µin	76.8, 153, 258, 488, 1011, 1992, 3704, 7620µin	8 pcs
ISR-CSE322	Reaming	16, 32, 63, 125µin	68, 128, 256, 512µin	4 pcs
	Drilling	63, 125, 250, 500µin	300, 620, 1240, 2400µin	4 pcs
ISR-CSE323	Horizontal milling	16, 32, 63, 125, 250, 500, 1000, 2000µin	72, 147, 265, 512, 1025, 2120, 3900, 7880µin	8 pcs
ISR-CSE325	Shaping (planing)	32, 63, 125, 250, 500, 1000, 2000, 4000µin	154, 268, 488, 1009, 1950, 3998, 7603, 14440µin	8 pcs
ISR-CSE326	Linishing (belt sanding)	4, 8, 16, 32, 63, 125µin	36, 62, 135, 297, 740, 1240µin	6 pcs
ISR-CSE328	Vertical grinding	8, 16, 32, 63, 125, 250µin	44, 140, 246, 351, 888, 1632µin	6 pcs
ISR-CSE329	Grit blasting	128, 420, 720, 1000µin	768, 2520, 4320, 6000µin	4 pcs
	Shot blasting	128, 320, 520, 720µin	768, 1920, 3120, 4320µin	4 pcs
ISR-CSE331	Spark erosion (EDM)	16, 32, 63, 125, 250, 500, 1000, 2000µin	100, 180, 288, 568, 988, 2048, 4200, 7840µin	8 pcs
ISR-CSE333	Hand filing	16, 32, 63, 125, 250µin	120, 224, 496, 900, 2440µin	5 pcs
ISR-CSE334	Castings	32, 63, 125, 250, 500, 1000, 2000µin	128, 320, 640, 1280, 2240, 4480, 9000µin	7 pcs
ISR-CSE335	Honing	2, 4, 8, 16, 32, 63µin	12, 22, 40, 80, 168, 360µin	6 pcs
ISR-CSE336	Polishing	.5, 1, 2, 4, 8µin	12, 14, 27, 29, 61µin	5 pcs

MEASURING ACCURACY CAN BE IMPROVED, IF THE CALIBRATION IS MADE ON A REFERENCE SPECIMEN WITH THE ROUGHNESS VALUE CLOSE TO THE WORKPIECE TO BE MEASURED

## SURFACE ROUGHNESS REFERENCE SPECIMENS

**INSIZE PLUS**  
MADE IN UK

- To calibrate roughness testers
- Meets ISO 5436-1: 2000
- Rust proof, made of pure Nickel

Part No.	Roughness (Ra)
ISR-RS525X	250µin/6.25µm *
ISR-RS526X	124µin/3.15µm *
ISR-RS527X	120µin/3.0µm *
ISR-RS528X	20µin/0.5µm *
ISR-RS529X	4µin/0.1µm * (not suitable for ISR-S400)
ISR-RS530X	40µin/1.0µm *
ISR-RS531X	14µin/0.3µm *(not suitable for ISR-S400)

\* The actual value may be slightly different

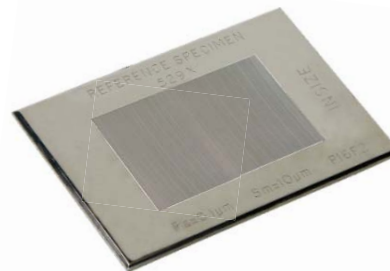

ISR-RS529X

## SHOT AND GRIT BLASTING SURFACE ROUGHNESS SPECIMENS



- To check the roughness of steel surfaces which have been blast cleaned before painting
- Meets ISO 8503/1
- Rust-proof, made of pure Nickel
- Each piece contains 4 parts



ISR-CSE017

Part No.	Machining method	Roughness (Ra)	Roughness (Rz)
ISR-CSE017	Shot blasting	125, 320, 520, 720µin	768, 1920, 3120, 4320µin
ISR-CSE018	Grit blasting	128, 420, 720, 1000µin	768, 2520, 4320, 6000µin

## COATING THICKNESS GAGE



SUITABLE FOR SMALL SURFACES, CONCAVE OR CONVEX SURFACES

FOR MAGNETIC AND NON-MAGNETIC SUBSTRATES

- Suitable for small surfaces, concave or convex surfaces
- Magnetic induction probe (Fe) is to measure the thickness of non-magnetic coating on magnetic substrate  
Substrate: iron, steel, magnetic stainless steel (does not include non-magnetic stainless steel)  
Coating: zinc, copper, chrome-tin, plastic powder, paint (does not include nickel)
- Eddy current probe (NFe) is to measure the thickness of non-conductive coating on non-magnetic metal substrate  
Substrate: copper, aluminum, zinc, non-magnetic stainless steel  
Coating: plastic powder, paint, anodizing

connected to probe



main unit  
ISO-2000FN



magnetic induction probe Fe (optional)  
ISO-2000FN-FE



eddy current probe NFe (optional)  
ISO-2000FN-NFE

### MAIN UNIT

Part No.	ISO-2000FN (without probe)	
Measuring range	magnetic induction probe (Fe)	0~80mils
	eddy current probe (NFe)	0~32mils
Accuracy	±(0.06+2%L)mils L is measuring thickness in mils	
Resolution	0.01mils (range<10mils)	
	0.1mils (range≥10mils)	
Repeatability	0.06mils (range<10mils)	
	0.1mils (range≥10mils)	
Measuring mode	continuous or single	
Calibration mode	four points calibration	
Minimum substrate thickness	magnetic induction probe (Fe): 8mils, eddy current probe (NFe): 2mils	
Minimum measuring area	.4x.4", calibration should be made on workpiece without coating, test stand (optional) is recommended in order to have same position for calibration and measurement	
Power supply	2×1.5V AA batteries	
Dimension of main unit	4.80×2.56×.87"	
Weight of main unit	.33lb	



standard foil (included)

### STANDARD DELIVERY

Main unit	1 pc
Zero calibration block for Fe probe	1 pc
Zero calibration block for NFe probe	1 pc
Standard foil	7 pcs
Battery (AA)	2 pcs

### PROBE (OPTIONAL)

Magnetic induction probe (Fe)	ISO-2000FN-FE
Eddy current probe (NFe)	ISO-2000FN-NFE

**FOR MAGNETIC AND NON-MAGNETIC SUBSTRATES**

- Magnetic induction probe (Fe) is to measure the thickness of non-magnetic coating on magnetic substrate  
Substrate: iron, steel, magnetic stainless steel (does not include non-magnetic stainless steel)  
Coating: zinc, copper, chrome, tin, plastic, powder, paint (nickel is not included)
- Eddy current probe (NFe) is to measure the thickness of non-conductive coating on non-magnetic substrate  
Substrate: copper, aluminum, zinc, non-magnetic stainless steel  
Coating: plastic, powder, paint, anodizing
- Low and high limits with judgement
- Automatic power off



magnetic induction probe Fe (included)



VIDEO



software CD (included)



calibration foils (included)



zero calibration block for Fe (included)



eddy current probe NFe (optional) with zero calibration block



magnetic induction probe (Fe/90°) for bores and grooves (optional)



magnetic induction probe (Fe10) for large range (optional)

**COATING THICKNESS GAGE  
PART NO. 9501-1200**

**SPECIFICATION**

Probe type	Fe (included)	NFe (optional)	Fe/90° (optional)	Fe10 (optional)
Measuring range	0~50mils	0~50mils	0~50mils	20~400mils
Accuracy	±(3%L+.04)mils L is measuring thickness in mils			
Resolution	.01mils			.1mils
Measuring mode	continuous and single			
Minimum substrate thickness	.02"	.012"	.02"	.08"
Minimum measuring area	.28" DIA	.2" DIA	.28" DIA	1.57" DIA
Minimum radius of convex workpiece	.06"	.12"	—	.4"
Memory	500			
Power supply	2×1.5V AA batteries			
Dimension	5.04×2.68×1.26"			
Weight	.75lb			

**STANDARD DELIVERY**

Main unit	1 pc
Magnetic induction probe (Fe)	1 pc
Zero calibration block for Fe probe	1 pc
Calibration foils (50µm/2mils, 100µm/4mils, 250µm/10mils, 500µm/20mils, 1000µm/40mils)	1 set
1.5V AA battery	2 pcs
USB cable and software	1 pc

**OPTIONAL ACCESSORY**

Eddy current probe (NFe) with zero calibration block	9501-1200-NFE
Magnetic induction probe (Fe/90°) for bores and grooves	9501-1200-FE90
Magnetic induction probe (Fe10) for large range	9501-1200-FE10

**DISPLAY MAXIMUM, MINIMUM, DIFFERENCE VALUE BETWEEN MAXIMUM AND MINIMUM**

**DATA OUTPUT**

- Measure peak-to-valley height of blast cleaned surface. If the profile is too low, the adhesion of the coating to the surface will be reduced. If the profile is too high, there is the danger that the profile peaks will remain uncoated, allowing rust spots to occur.
- Meet ASTM D 4417-B
- Zero set block is included, set zero before measurement
- Button function: tolerance Go and No-Go display, data preset, measuring direction change, max./min./TIR measurement, inch/metric conversion, absolute/incremental measurement
- CR2032 battery, automatic power off
- Data output
- Stainless steel base
- Optional accessory: data output cable (part no. 7306-40, 7302-SPC3A, 7305-SPC1A, 7305-C01)



2844-10

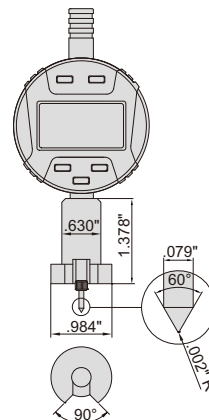

measure peak-to-valley height of blast cleaned surfaces

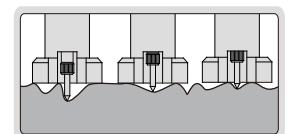

Part No.	Range	Digital indicator stroke	Digital indicator resolution	Accuracy
2844-10	0-.5"/0-12.7mm	.5"/12.7mm	.00005"/0.001mm	±.0002"



## ELECTRONIC SURFACE PROFILE GAGE

- Measure peak-to-valley height of blast cleaned surface. If the profile is too low, the adhesion of the coating to the surface will be reduced. If the profile is too high, there is the danger that the profile peaks will remain uncoated, allowing rust spots to occur.
- Meet ASTM D 4417-B
- Zero set block is included, set zero before measurement
- Button function: on/off, zero, inch/mm, absolute/incremental measurement
- CR2032 battery, automatic power off
- Data output
- Stainless steel base
- Optional accessory: data output cable (part no. 7306-40, 7302-SPC3A, 7305-SPC1A, 7305-C01)



2843-10

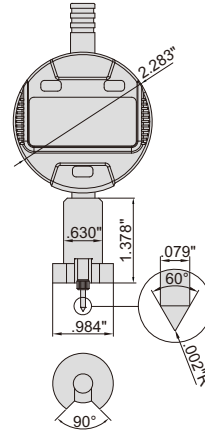

DATA OUTPUT



measure peak-to-valley height of blast cleaned surfaces

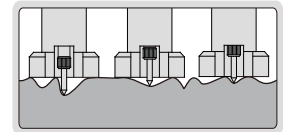

Part No.	Range	Digital indicator stroke	Digital indicator resolution	Accuracy
2843-10	0-.5"/0-12.7mm	.5"/12.7mm	.00005"/0.001mm	±.0002"

## ULTRASONIC THICKNESS GAGE (THROUGH COATING) PART NO. ISU-300D

- Two measuring modes, Echo-Echo (E-E) and Transmit-Echo (T-E):
  - E-E is applicable for non-metallic coating (such as paint, plastic resin, etc.) on metal substrate, can penetrate coating and measure the thickness of substrate
  - T-E is to measure the thickness of material without coating, such as metal, plastic, glass, nylon, resin, ceramics, ice, etc.
- Low and high limits with judgment
- Average calculation of maximum 9 readings
- Memory of maximum 500 readings

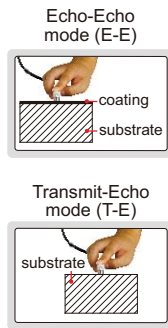

DATA OUTPUT

PENETRATE NON-METALLIC COATING AND MEASURE THE THICKNESS OF METAL SUBSTRATE

INSPECTION CERTIFICATE



.16" block for calibration

LCD with backlight

USB port  
transducer ISU-T07

couplant (included)

transducer ISU-T04 (optional)

transducer ISU-T06 (optional)

transducer ISU-T12 (optional)

transducer ISU-T13 (optional)

### SPECIFICATION

Measuring range	E-E mode: coating thickness 0~.04", substrate thickness .16~.98"
	T-E mode: substrate thickness .06~7.87"
Resolution	.001" (range<10")
	.01" (range≥10")
Repeatability	.001" (range<4")
	.004" (range 4~10")
Accuracy	±.002" (range<.4")
	±(.002+H/1000)" (range .4~4") ±H/333" (range≥4") H is the thickness to be measured in inch
Velocity	.039~.394inch/μs
Power supply	2×1.5V AAA batteries
Dimension	4.57×2.52×1.06"
Weight	.49lb



### STANDARD DELIVERY

Main unit	1 pc
Transducer ISU-T07	1 pc
Battery (AAA)	2 pcs
Couplant (for ISU-T04, ISU-T06, ISU-T07, ISU-T12)	1 bottle
USB cable	1 pc

### OPTIONAL ACCESSORY

Transducer	ISU-T04, ISU-T06, ISU-T12, ISU-T13
Couplant (for ISU-T13)	ISU-HT5-COUPPLANT

### SPECIFICATION OF TRANSDUCERS

Part No.	Mode	Frequency	Diameter (d)	Measuring range	Minimum size of pipe for measurement (diameter × wall thickness)	Applicable temperature	Application
ISU-T07	T-E E-E	5.0MHz	.43" DIA	T-E mode .06~7.87" E-E mode .16~.98"	T-E mode .79×.05" E-E mode .79×.16"	<140°F	general use
ISU-T04	T-E	10.0MHz	.24" DIA	.03~0.79"	.39×.04"	<140°F	for small tube
ISU-T06	T-E	7.5MHz	.33" DIA	.03~1.97"	.59×.05"	<140°F	for thin material
ISU-T12	T-E	2.0MHz	.64" DIA	.08~15.75"	1.18×.16"	<140°F	for casting iron
ISU-T13	T-E	5.0MHz	.51" DIA	.08~7.87"	.98×.12"	<662°F	for high temperature



DATA OUTPUT



- Measure the thickness from one side of object, suitable for pipe, tank, etc.
- Applicable material: metal, plastic, glass, nylon, resin, ceramic, ice
- Low and high limits with judgement
- Average calculation of maximum 9 readings
- Memory of maximum 5000 readings with location number

**SPECIFICATION**

Resolution	.001" (range<10")
	.01" (range≥10")
Repeatability	.001" (range<4")
	.004" (range 4~10")
Accuracy	±.002" (range<.4")
	±(.002+H/1000)" (range .4~4")
	±H/333" (range≥4")
	H is the thickness to be measured in inch
Velocity	.039~.394inch/μs
Power supply	2×1.5V AAA batteries
Dimension	2.52×4.57×1.06"
Weight	.49lb

**ULTRASONIC THICKNESS GAGE PART NO. ISU-250C**



couplant (included)



transducer ISU-T04 (optional)



transducer ISU-T06 (optional)



transducer ISU-T12 (optional)



transducer ISU-T13 (optional)

**STANDARD DELIVERY**

Main unit	1 pc
Transducer ISU-T08	1 pc
Battery (AAA)	2 pcs
Couplant (for ISU-T04, ISU-T06, ISU-T08, ISU-T12)	1 bottle
USB cable	1 pc

**OPTIONAL ACCESSORY**

Transducer	ISU-T04, ISU-T06, ISU-T12, ISU-T13
Couplant (for ISU-T13)	ISU-HT5-COUPPLANT

**SPECIFICATION OF TRANSDUCERS**

Part No.	Frequency	Diameter (d)	Measuring range	Minimum size of pipe for measurement (diameter × wall thickness)	Applicable temperature	Application
ISU-T08	5.0MHz	.43" DIA	.03-11.81"	.79×.05"	<140°F	general use
ISU-T04	10.0MHz	.24" DIA	.03-.79"	.39×.04"	<140°F	for small tube
ISU-T06	7.5MHz	.33" DIA	.03-1.97"	.59×.05"	<140°F	for thin material
ISU-T12	2.0MHz	.64" DIA	.08-15.75"	1.18×.16"	<140°F	for casting steel
ISU-T13	5.0MHz	.51" DIA	.08-7.87"	.98×.12"	<662°F	for high temperature

ATTENTION: NOT SUITABLE FOR CASTING WORKPIECES



**ULTRASONIC THICKNESS GAGE (BASIC MODEL) PART NO. ISU-100D**

- Measure the thickness from one side of object, suitable for pipe, tank, etc.
- Applicable material: metal, plastic, glass, nylon, resin, ceramic, ice

**SPECIFICATION**

Measuring range	.03~11.81"	
Resolution	.001" (range<10")	
	.01" (range≥10")	
Accuracy	±.002" (range<.4")	
	±(.002+H/1000)" (range .4~4")	
	±H/333" (range≥4")	
	H is the thickness to be measured in inch	
Transducer	frequency	5MHz
	diameter (d)	.43" DIA
Minimum size of pipe for measurement	.79×.05" (diameter × wall thickness)	
Applicable temperature	<140°F	
Velocity	.039~.394 inch/μs	
Power supply	2×AAA batteries	
Dimension	4.49×2.52×1.1"	
Weight	.49lb	



**STANDARD DELIVERY**

Main unit	1 pc
Transducer	1 pc
Couplant	1 bottle
Battery (AAA)	2 pcs



## LASER DISTANCE METER PART NO. 9561-80

- Large display with backlight
- Unit: in, ft, m
- Distance, area, volume and height measurement
- Continuous measuring mode to track maximum and minimum value
- Memory of 99 measurement values
- Automatic power off: laser 20s, main unit 150s



### SPECIFICATION

Measuring range	2"~262ft
Accuracy	±.12"
Resolution	.1", .01ft, 1mm, 10mm
Measuring speed	.5 second
Laser type	635nm, Class II, <1mW
Power supply	3×AAA batteries, for 4000 measurements
Dimension (L×W×H)	4.72×2.36×1.1"
Weight	.38lb

### STANDARD DELIVERY

Main unit	1 pc
Battery (AAA)	3 pcs

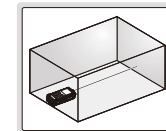

distance measurement

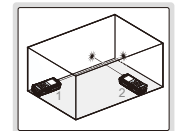

area measurement

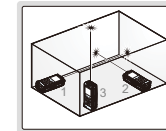

volume measurement

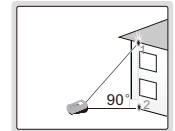

height measurement

## INFRARED THERMOMETER PART NO. 9110-500

- Fast measurement with infrared or k-type sensor
- Maximum, minimum, average and difference modes
- Low and high limits with judgement
- Automatic power off



### SPECIFICATION

Measuring range	infrared	-76~932°F
	k-type sensor	-40~1976°F
Accuracy	infrared	±(1.5%+4)°F
	k-type sensor	±(1%+4)°F
Resolution		.1°F (range<199.9°F), 1°F (range>199.9°F)
Distance to spot ratio (D:S)		12:1
Emissivity		0.1~1 (adjustable)
Laser type		630~670nm, Class II, <1mW
Response time		<500ms
Power supply		9V battery
Dimension		6.93×5.19×1.93"
Weight		.5lb

### STANDARD DELIVERY

Main unit	1 pc
K-type sensor	1 pc
9V battery	1 pc

k-type sensor (included)



**DATA OUTPUT**

- Measure velocity, flow, temperature and relative humidity
- Velocity unit: mil/h, ft/m, ft/s, m/s, km/h, knots
- Flow unit: CMS (cubic meter per second), CMM (cubic meter per minute), CFM (cubic feet per minute)
- Temperature type: ambient, dew point, wet bulb
- Maximum and minimum modes
- Automatic power off



software CD (included)



VIDEO

**DIGITAL ANEMOMETER  
PART NO. 9331-40**



**SPECIFICATION**

Measuring range	velocity	.9~67.2mil/h, 1.3~98.5ft/s, 78~5900ft/m, .8~30m/s, 1.4~108km/h, .8~58.3knots
	flow	0~9999CMS, 0~99990CMM, 0~99990CFM
	temperature	-4~140°F/-20~60°C
	relative humidity	0~100%RH
Accuracy	velocity	±(2%+0.5) for mil/h, ft/s, m/s, km/h, knots ±(2%+50) for ft/m
	temperature	±2.7°F/±1.5°C
	relative humidity	±3% (20~80%RH), ±5% (<20%RH or >80%RH)
	relative humidity	±3% (20~80%RH), ±5% (<20%RH or >80%RH)
Resolution	velocity	.01mil/h, .01ft/s, 1ft/m, .01m/s, .01km/h, .01knots
	flow	.01CMS, .1CMM, .1CFM
	temperature	.1°F/0.1°C
	relative humidity	.1%RH
Flowing area range	0~9.999ft²/0~9.999m²	
Sampling time	.4s	
Maximum working height	2000m	
Output	USB	
Power supply	9V battery	
Dimension	1.56×3.35×1.49"	
Weight	.44lb	

**STANDARD DELIVERY**

Main unit	1 pc
USB cable and software	1 pc
9V battery	1 pc

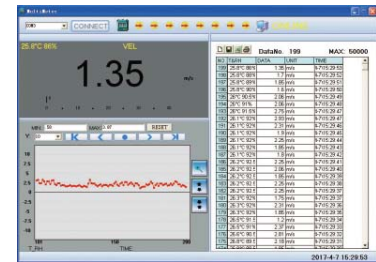

software (included), display measurement values and graph, save and output data

**DIGITAL MOISTURE METER  
PART NO. 9341-50**

- Suitable for wood, smooth cement, hard gypsum, mixed mortar, brick, etc.
- Measure moisture, temperature and relative humidity
- Temperature type: ambient, dew point, wet bulb
- Maximum and minimum modes
- Automatic power off



VIDEO



cover (included)



**SPECIFICATION**

Measuring depth	0~1.97"	
Measuring range	Moisture	0~60%
	temperature	14~122°F/-10~50°C
	relative humidity	0~100%RH
Accuracy	Moisture	±2%
	temperature	±2%
	relative humidity	±5%RH
Resolution	Moisture	.1%
	temperature	.1°C/0.1°F
	relative humidity	.1%RH
Sampling time	.5s for moisture 1s for temperature and relative humidity	
Power supply	2×AAA batteries	
Dimension	5.12×2.2×1.14"	
Weight	.46lb	

**STANDARD DELIVERY**

Main unit	1 pc
Battery (AAA)	2 pcs



## DIGITAL SOUND LEVEL METER PART NO. 9351-130

DATA  
OUTPUT

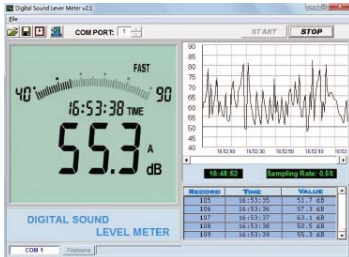

software (included), display measurement values and graph, save and output data



- Automatically select best range: 30~80dB, 40~90dB, 50~100dB, 60~110dB, 70~120dB, 80~130dB
- Over range indicator
- Real time, average, maximum modes
- Memory 16000 measurement values
- AC signal output: 0.707 Vrms at FS, impedance approx. 600Ω
- DC signal output: 10mV/dB, impedance approx. 100Ω
- Automatic power off



software CD (included)

### SPECIFICATION

Measuring range	30~130dB
Accuracy	±2dB
Resolution	.1dB
Sampling time	.5s for digital, .05s for analogue
Response time	fast: 125ms, slow: 1s
Frequency	30Hz~8KHz
Frequency weighting	A/C
Microphone	electret condenser type
Output	RS232, AC/DC
Power supply	6×AAA batteries
Dimension	10.43×3.15×2.71"
Weight	.7lb

### STANDARD DELIVERY

Main unit	1 pc
RS232 cable and software	1 pc
Output connector	1 pc
Battery (AAA)	6 pcs

## NON-CONTACT DIGITAL TACHOMETER PART NO. 9221-999

- Maximum and minimum modes
- Memory 100 measurement values
- Automatic power off



reflection sticker (included)



### SPECIFICATION

Measuring range	50~99999RPM
Accuracy	±(.03%+2)RPM
Resolution	.01RPM (range 50~99.99RPM)
	1RPM (range 100~9999.9RPM)
Measuring distance	2~10"
	10000~99999RPM
Power supply	4×AAA batteries
Dimension	6.1×2.36×1.06"
Weight	.26lb

### STANDARD DELIVERY

Main unit	1 pc
Reflection sticker	1 roll
Battery (AAA)	4 pcs

## CONTACT DIGITAL TACHOMETER PART NO. 9222-199

- Unit: RPM, ft/min, ft/sec, in/min, m/min, m/sec
- Maximum and minimum modes
- Memory 100 measurement values
- Automatic power off



### SPECIFICATION

Measuring range	50~19999RPM
Accuracy	±(.03%+2)RPM
Resolution	.01RPM (range 50~99.99RPM)
	1RPM (range 10000~19999RPM)
Power supply	4×AAA batteries
Dimension	7.2×2.36×1.06"
Weight	.27"

### STANDARD DELIVERY

Main unit	1 pc
Wheel with 0.1m perimeter	1 pc
Wheel with 6" perimeter	1 pc
Cone cavity head	1 pc
Cone head	1 pc
Extension rod	1 pc
Battery (AAA)	4 pcs



wheel with 0.1m perimeter (included)



cone cavity head (included)



extension rod (included)



wheel with 6" perimeter (included)



cone head (included)

## 60° GLOSS METER PART NO. ISQ-DG6

- To test the gloss of coating, such as painting, varnish, printing ink, etc.
- To test the material surfaces, such as metal, granite, ceramic, plastic, paper, etc.
- According to ISO 2813, ASTM D2457, ASTM D523
- Automatic power off



base with calibration block (included)

### SPECIFICATION

Incidence angle	60°
Measuring range	0~150GU
Resolution	0.1GU
Accuracy	±1.2GU
Repeatability	0.4GU
Zero set error	0.2GU
Measuring area	.79×.39"
Power supply	1×1.5V AA battery
Dimension	4.84×1.50×2.56"
Weight	.66lb

### STANDARD DELIVERY

Main unit	1 pc
Base with calibration block	1 pc
Spare calibration block	1 pc

### DATA OUTPUT

- To test the gloss of coating, such as painting, varnish, printing ink, etc.
- To test the material surfaces, such as metal, granite, ceramic, plastic, paper, etc.
- According to ISO 2813, ASTM D2457, ASTM D523
- Memory of 10000 measurement results for browsing and output
- Automatic power off



## 20°/60°/85° GLOSS METER PART NO. ISQ-DG8



base with calibration block (included)



### SPECIFICATION

Incidence angle	20°	60°	85°
Measuring range	0~2000GU	0~1000GU	0~160GU
Resolution	0.1GU (range≤119.9GU)		
	1GU (range>119.9GU)		
Accuracy	±1.5GU (range≤119.9GU)		
	±1.5% (range>119.9GU)		
Repeatability	0.2GU (range≤119.9GU)		
	0.2% (range>119.9GU)		
Zero set error	0.2GU		
Measuring area	.39×.35"	.63×.35"	1.54×.20"
Power supply	1×1.5V AA battery		
Dimension	6.10×1.89×2.95"		
Weight	.88lb		



software CD (included)

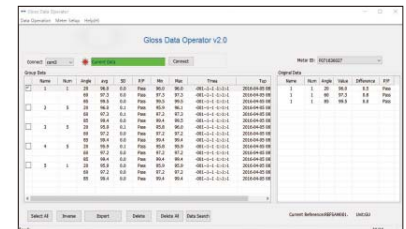

software (included), output to Excel

### STANDARD DELIVERY

Main unit	1 pc
Base with calibration block	1 pc
USB cable and software	1 pc

### SUITABLE FOR WATER BASED COOLANT

- Quickly measure the concentration of coolant
- Refer to the refraction factor of coolant, for example: the refraction factor of grinding emulsion is 2.1, the reading value is 6%, so the actual concentration is  $(2.1 \times 6\%) = 12.6\%$

### SPECIFICATION

Measuring range	0~32%
Graduation	0.2%
Dimension	1.06×1.57×6.3"
Weight	.39lb

## PORTABLE REFRACTOMETER PART NO. ISQ-RM30



## ELECTRONIC LEVEL PART NO. ISE-2DT

- Color LCD, touch panel
- X-Y axis measurement
- Set the tolerance and the display is shown in different colors



within the tolerance (green)    slightly out of the tolerance (yellow)    seriously out of the tolerance (red)

- To show the incline with line or bubble

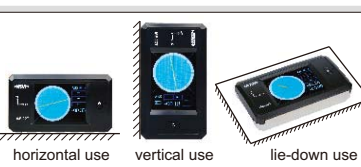
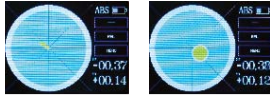

horizontal use    vertical use    lie-down use



DATA OUTPUT

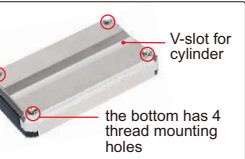

### SPECIFICATION

Measuring range	±30°
Resolution	0.01°, 0.1mm/m(=0.001in/ft)
Accuracy	±0.03° (range 0~3°) ±0.05° (range >3°)
Power supply	rechargeable battery
Dimension	4.53×2.60×.91"
Weight	0.49lb



### STANDARD DELIVERY

Main unit	1 pc
USB cable	1 pc

### OPTIONAL ACCESSORY

Software	ISE-2DT-SOFTWARE
----------	------------------

## ELECTRONIC LEVEL AND PROTRACTOR

- IP67 WATERPROOF
- ABSOLUTE LEVEL
- BACKLIGHT
- BUZZER ALARM AT 0° AND 90°

- IP67 dust/waterproof
- Aluminum frame, shock absorbing rubber end caps
- Magnetic bottom with V-groove for shafts
- The sea level is permanently set inside the chip, zero setting is not needed when batteries are replaced
- Buttons: ON/OFF, backlight/buzzer alarm, absolute and incremental measurement, unit (°, %, mm/m), HOLD (keep the reading)
- Three AAA batteries
- Automatic power off



2175-360

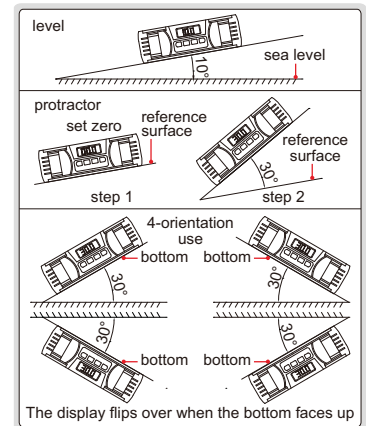
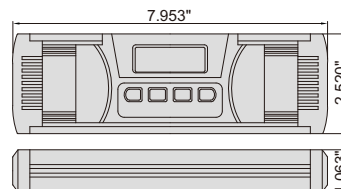

The display flips over when the bottom faces up

Part No.	Range	Resolution	Accuracy
2175-360	0-360° (90°x4)	0.05° (=0.873mm/m)	at 0°: ±0.05°; others: ±0.1°

## ELECTRONIC LEVEL AND PROTRACTOR

- IP54 WATERPROOF
- ABSOLUTE LEVEL
- BACKLIGHT
- BUZZER ALARM AT 0° AND 90°

- IP54 dust/waterproof
- Aluminum frame
- Magnetic bottom with V-groove for shafts
- The sea level is permanently set inside the chip, zero setting is not needed when batteries are replaced
- Buttons: ON/OFF, absolute and incremental measurement, keep the reading, buzzer alarm, unit (in/ft, %, mm/m), backlight
- Two AAA batteries
- Automatic power off



2179-360

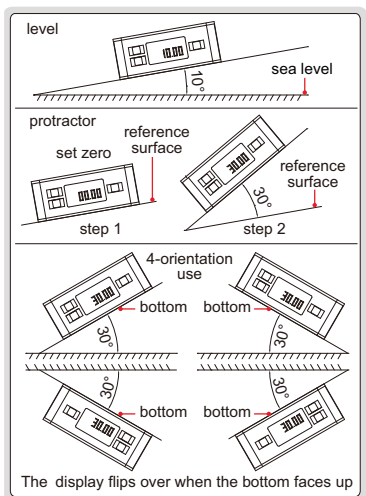
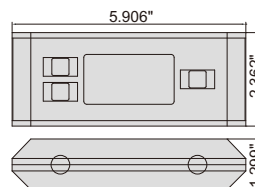

The display flips over when the bottom faces up

Part No.	Range	Resolution	Accuracy
2179-360	0-360° (90°x4)	0.05°/1.25in/ft	at 0° and 90°: ±0.1°; others: ±0.2°



BACKLIGHT

ABSOLUTE LEVEL

MAGNETIC BOTTOM

DISPLAY FLIPS OVER WHEN THE BOTTOM FACES UP

## ELECTRONIC LEVEL AND PROTRACTOR

- Aluminum frame
- Magnetic bottom
- The display flips over when the bottom faces up
- The backlight is on automatically when in use, and automatically off in 15 minutes after use
- The sea level is permanently set inside the chip, zero setting is not needed when battery is replaced
- Buttons: ON/OFF, ZERO, absolute and incremental measurement
- One AAA battery
- Automatic power off in 5 minutes



2170-1

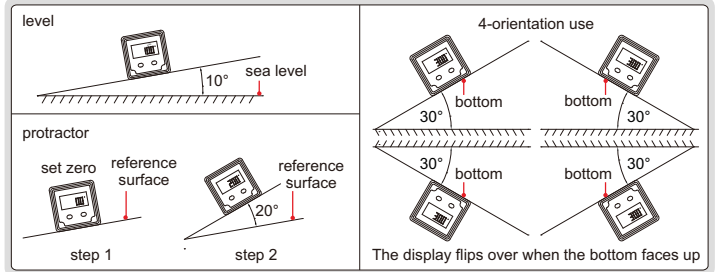
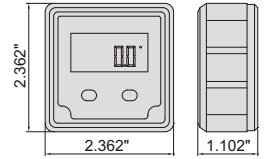

Part No.	Range	Resolution	Accuracy
2170-1	4x90°	0.1°(=.021in/ft)	at 0°and 90°: ±0.1°; others: ±0.2°

NO NEED TO SET ZERO BEFORE USE

- No need to set zero before use
- Three V-grooves for shafts (shafts diameter .76~4.56")
- With longitudinal vial

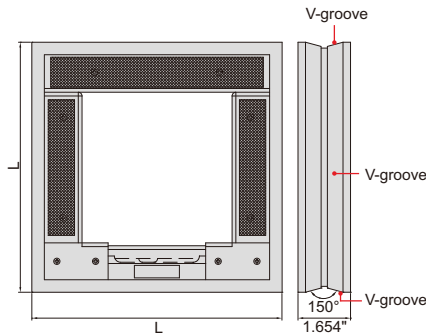

## FRAME LEVELS

INSIZE PLUS  
MADE IN GERMANY



4906-200

Part No.		Size (LxL)
Sensitivity .00024in/ft (=0.001°)	Sensitivity .0012in/ft (=0.0057°)	
4906-150	4906-B150	6x6"
4906-200	4906-B200	8x8"
4906-300	4906-B300	12x12"

ATTENTION: BASIC MODEL

- V-groove on bottom and left for shafts (shafts diameter .59~2.76")
- With transverse vial
- Supplied with adjusting wrench

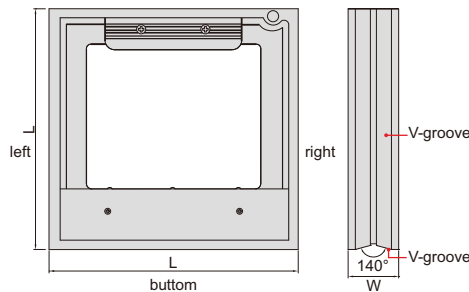

## FRAME LEVELS



4902-8

Part No.		Size (LxL)	W
Sensitivity .00024in/ft (=0.001°)	Sensitivity .0006in/ft (=0.0029°)		
4902-6	4902-C6	6x6"	1.575"
4902-8	4902-C8	8x8"	1.575"
4902-12	4902-C12	12x12"	1.772"



## BLOCK LEVELS

**INSIZE PLUS**  
MADE IN GERMANY

NO NEED TO SET  
ZERO BEFORE USE



4905-200

- No need to set zero before use
- V-groove on bottom for shafts (shafts diameter .76~4.56")
- With longitudinal vial

Part No.		Length (L)
Sensitivity .00024in/ft (=0.001°)	Sensitivity .0012in/ft (=0.0057°)	
4905-160	4905-B160	6"
4905-200	4905-B200	8"
4905-300	4905-B300	12"
4905-500	4905-B500	20"

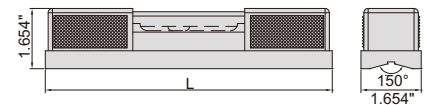

## BLOCK LEVELS

ATTENTION:  
BASIC MODEL



4901-8

- V-groove on bottom for shafts (shafts diameter .63~2.76")
- With transverse vial
- Supplied with adjusting wrench

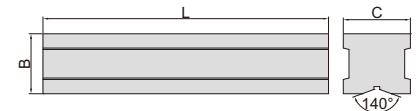

Part No.		Length (L)	B	C
Sensitivity .00024in/ft (=0.001°)	Sensitivity .0006in/ft (=0.0029°)			
4901-6	4901-C6	6"	1.575"	1.772"
4901-8	4901-C8	8"	1.654"	1.850"
4901-12	4901-C12	12"	1.772"	1.969"

## SHORT LEVEL

**INSIZE PLUS**  
MADE IN GERMANY

NO NEED TO SET  
ZERO BEFORE USE



4907-90

- No need to set zero before use
- Suitable for small spaces like crankshaft
- Longitudinal and transverse V-grooves on bottom for shafts (shafts diameter .76~4.56")
- With transverse vial

Part No.	Length	Sensitivity
4907-90	3.5"	.0012in/ft (=0.0057°)

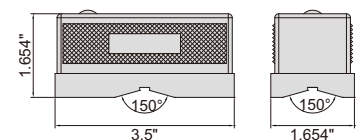

NO NEED TO SET ZERO BEFORE USE

- No need to set zero before use
- With mounting holes (for M5 screws)



4908-100

MINI LEVEL  
INSIZE PLUS  
MADE IN GERMANY

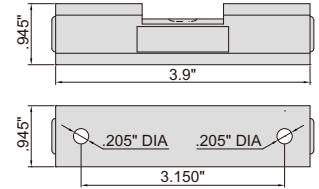

Part No.	Length	Sensitivity
4908-100	3.9"	.0012in/ft (=0.0057°)

NO NEED TO SET ZERO BEFORE USE

- With transverse and longitudinal vials
- No need to set zero before use



4909-60

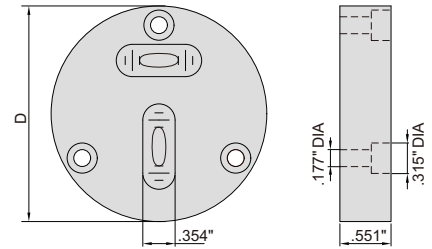

4909-80

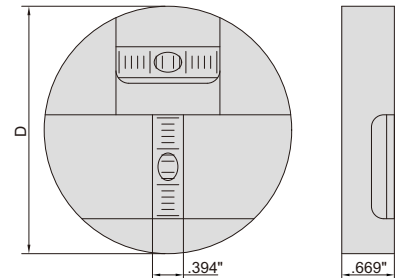

Part No.	Sensitivity	D
4909-60	.004 in/ft (=0.3mm/m)	2.36" DIA
4909-80	.008 in/ft (=0.6mm/m)	3.15" DIA

ABSOLUTE LEVEL

BACKLIGHT

BUZZER ALARM AT 0° AND 90°

- With transverse and longitudinal vials
- Used as level and protractor
- Aluminum frame
- Magnetic bottom
- The sea level is permanently set inside the chip, zero setting is not needed when batteries are replaced
- Buttons: ON/OFF, absolute and incremental measurement, keep the reading, buzzer alarm, unit (in/ft, %, mm/m) conversion, backlight
- The display flips over when the bottom faces up
- Two AAA batteries
- Automatic power off

Part No.	Range	Resolution	Accuracy
4910-600	0-360° (90°x4)	0.1°/.125in/ft	at 0° and 90°: ±0.1°; others: ±0.2°

ELECTRONIC LEVEL



4910-600

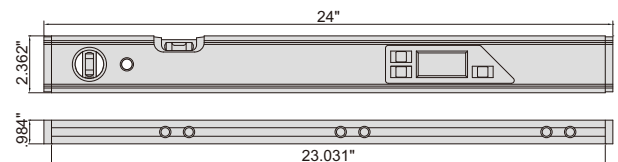

## ALUMINUM ALLOY LEVELS

- Die casting aluminum alloy frame
- With three vials: 180°, 90° and 45°
- Zero position of 180° vial can be set



4911-600

Part No.	Length (L)	Accuracy
4911-400	16"	.009in/ft
4911-600	24"	.009in/ft
4911-800	32"	.009in/ft

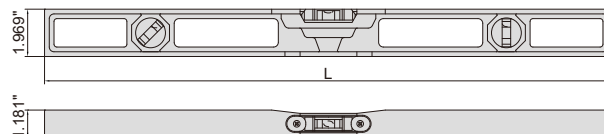

## PORTABLE LEVEL

MAGNETIC BASE

VIALS MADE IN ISRAEL  
LIFETIME WARRANTY

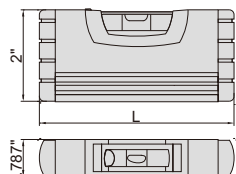

4912-100

- Shockproof vials
- Magnetic base
- Shock absorbing rubber end caps
- Working temperature: 5°F~131°F

Part No.	Size (L)	Accuracy
4912-100	4"	.006in/ft (0.5mm/m)

packaging



## CAST ALUMINUM LEVEL

MAGNETIC BASE

VIALS MADE IN ISRAEL  
LIFETIME WARRANTY

- Shockproof horizontal and vertical vials
- Magnetic base
- Working temperature: 5°F~131°F
- Cast aluminum body



4913-250

packaging



Part No.	Size (L)	Accuracy
4913-250	10"	.006in/ft (0.5mm/m)

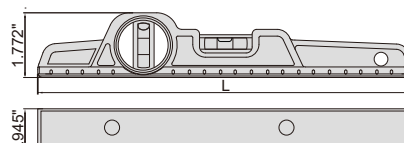

## ALUMINUM LEVELS

MAGNETIC BASE

VIALS MADE IN ISRAEL  
LIFETIME WARRANTY

- Shockproof horizontal and vertical vials
- Magnetic base
- Shock absorbing rubber end caps
- Working temperature: 5°F~131°F



4914-600

Part No.	Size (L)	Accuracy
4914-600	24"	.006in/ft (0.5mm/m)
4914-800	32"	.006in/ft (0.5mm/m)
4914-1000	40"	.006in/ft (0.5mm/m)
4914-1200	48"	.006in/ft (0.5mm/m)

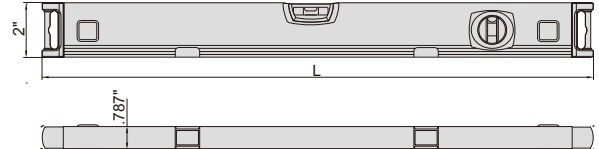

FORCE LOADING BY ELECTRIC  
MOTOR (WITHOUT WEIGHTS)

DATA  
OUTPUT

## AUTOMATIC DIGITAL ROCKWELL HARDNESS TESTER PART NO. ISH-RSR400-U\*\*

INSPECTION  
CERTIFICATE

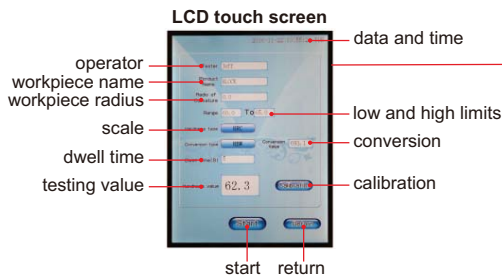

automatic testing

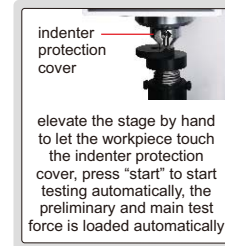

- Automatic testing, the preliminary and main test force is loaded automatically
- LCD touch screen, easy operation
- Convert to other Rockwell scales, HV or HB automatically
- Low and high limits
- Insert USB flash disk, save the testing results as Excel
- Self-correcting the hardness value for curved workpiece
- Force loading by electric motor (without weights)
- The test force is selected automatically according to hardness scale

### SPECIFICATION

Hardness scale	HRA, HRB, HRC, HRD HRF, HRG (with standard indenters) HRE, HRH, HRK, HRL, HRM, HRP HRR, HRS, HRV (with optional indenter)
Preliminary test force	98N/10kgf
Test force	588N/60kgf, 980N/100kgf, 1471N/150kgf
Stage elevation	manual
Load control	automatic (load/dwell/unload)
Load dwell time	0~60 second
Resolution	0.1HR
Output	USB
Max. workpiece height	8.66"
Max. workpiece depth	7.87" (from the center of indenter)
Power supply	110V, 50/60Hz **
Dimension	20.08×10.24×30.71"
Weight	155lb

### STANDARD DELIVERY

Main unit	1 pc
2.48" DIA flat anvil	1 pc
5.91" DIA flat anvil	1 pc
V-type anvil	1 pc
Diamond indenter	1 pc
1/16" carbide ball indenter	1 pc
Hardness test block HRB88~95	1 pc
Hardness test block HRC60~65	1 pc
Hardness test block HRC20~30	1 pc
USB flash disk (8G)	1 pc
Level	1 pc
Touch pen	1 pc
Anti-dust cover	1 pc



### OPTIONAL ACCESSORY

Hardness test block HRB88~95	ISH-BHRB
Hardness test block HRC60~65	ISH-BHRC3
Hardness test block HRC20~30	ISH-BHRC1
Small V-type anvil	ISH-SMALL ANVIL



# AUTOMATIC DIGITAL SUPERFICIAL ROCKWELL HARDNESS TESTER

PART NO. ISH-RSR500-U\*\*

FORCE LOADING BY ELECTRIC MOTOR (WITHOUT WEIGHTS)

**INSPECTION CERTIFICATE**

DATA OUTPUT



- Automatic testing, the preliminary and main test force is loaded automatically
- LCD touch screen, easy operation
- Convert to other Rockwell scales, HV or HB automatically
- Low and high limits
- Insert USB flash disk, save the testing results as Excel
- Self-correcting the hardness value for curved workpiece
- Force loading by electric motor (without weights)
- The test force is selected automatically according to hardness scale



2.48" DIA flat anvil (included)



5.91" DIA flat anvil (included)



level (included)



touch pen (included)



V-type anvil (included) for cylinders with diameter .16~2.36 DIA



small V-type anvil (optional) for cylinders with diameter.08~.16 DIA

## SPECIFICATION

Hardness scale	HR15N, HR30N, HR45N, HR15T, HR30T, HR45T (with standard indenters)
	HR15W, HR30W, HR45W, HR15X, HR30X, HR45X, HR15Y, HR30Y, HR45Y (with optional indenter)
Preliminary test force	29.4N/3kgf
Test force	147.1N/15kgf, 294.2N/30kgf, 441.3N/45kgf
Stage elevation	manual
Load control	automatic (load/dwell/unload)
Load dwell time	0~60 second
Resolution	0.1HR
Output	USB
Max. workpiece height	8.66"
Max. workpiece depth	7.87" (from the center of indenter)
Power supply	110V, 50/60Hz**
Dimension	20.08×10.24×30.71"
Weight	155lb

## STANDARD DELIVERY

Main unit	1 pc
2.48" DIA flat anvil	1 pc
5.91" DIA flat anvil	1 pc
V-type anvil	1 pc
Diamond indenter	1 pc
1/16" carbide ball indenter	1 pc
Hardness test block 78~88HR15N	1 pc
Hardness test block 55~73HR30N	1 pc
Hardness test block 57~69HR30T	1 pc
USB flash disk (8G)	1 pc
Level	1 pc
Touch pen	1 pc
Anti-dust cover	1 pc

## OPTIONAL ACCESSORY

Hardness test block 78~88HR15N	ISH-BHR15N1
Hardness test block 55~73HR30N	ISH-BHR30N1
Hardness test block 57~69HR30T	ISH-BHR30T1
Small V-type anvil	ISH-SMALLANVIL

# AUTOMATIC DIGITAL ROCKWELL AND SUPERFICIAL ROCKWELL HARDNESS TESTER PART NO. ISH-RSR600-U\*\*

FORCE LOADING BY ELECTRIC MOTOR (WITHOUT WEIGHTS)

DATA OUTPUT

INSPECTION CERTIFICATE

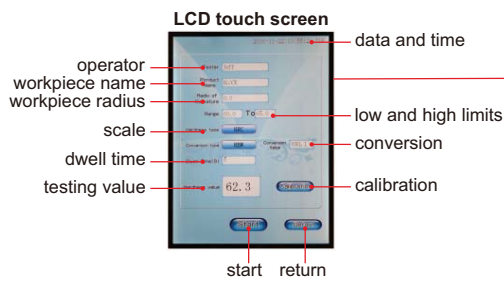

- Automatic testing, the preliminary and main test force is loaded automatically
- LCD touch screen, easy operation
- Convert to other Rockwell scales, HV or HB automatically
- Low and high limits
- Insert USB flash disk, save the testing results as Excel
- Self-correcting the hardness value for curved workpiece
- Force loading by electric motor (without weights)
- The test force is selected automatically according to hardness scale



2.48" DIA flat anvil (included)



5.91" DIA flat anvil (included)



level (included)



touch pen (included)



V-type anvil (included) for cylinders with diameter .16~2.36 DIA



small V-type anvil (optional) for cylinders with diameter .08~.16 DIA



## SPECIFICATION

Hardness scale	HRA, HRB, HRC, HRD, HRF, HRG, HR15N/T, HR30N/T, HR45N/T (with standard indenters) HRE, HRH, HRK, HRL, HRM, HRP, HRR, HRS, HRV, HR15W/X/Y, HR30W/X/Y, HR45W/X/Y (with optional indenter)
Preliminary test force	29.4N/3kgf for superficial Rockwell 98N/10kgf for Rockwell
Test force	147.1N/15kgf, 294.2N/30kgf, 441.3N/45kgf, 588N/60kgf, 980N/100kgf, 1471N/150kgf
Stage elevation	manual
Load control	automatic (load/dwell/unload)
Load dwell time	0~60 second
Resolution	0.1HR
Output	USB
Max. workpiece height	8.66"
Max. workpiece depth	7.87" (from the center of indenter)
Power supply	110V, 50/60Hz **
Dimension	20.08×10.24×30.71"
Weight	155lb

## STANDARD DELIVERY

Main unit	1 pc
2.48" DIA flat anvil	1 pc
5.91" DIA flat anvil	1 pc
V-type anvil	1 pc
Diamond indenter	1 pc
1/16" carbide ball indenter	1 pc
Hardness test block HRB88~95	1 pc
Hardness test block HRC60~65	1 pc
Hardness test block HRC20~30	1 pc
Hardness test block 78~88HR15N	1 pc
Hardness test block 55~73HR30N	1 pc
Hardness test block 57~69HR30T	1 pc
USB flash disk (8G)	1 pc
Level	1 pc
Touch pen	1 pc
Anti-dust cover	1 pc

## OPTIONAL ACCESSORY

Hardness test block HRB88~95	ISH-BHRB
Hardness test block HRC60~65	ISH-BHRC3
Hardness test block HRC20~30	ISH-BHRC1
Hardness test block 78~88HR15N	ISH-BHR15N1
Hardness test block 55~73HR30N	ISH-BHR30N1
Hardness test block 57~69HR30T	ISH-BHR30T1
Small V-type anvil	ISH-SMALL ANVIL

# AUTOMATIC DIGITAL ROCKWELL HARDNESS TESTER (DOLPHIN-NOSE MODEL) PART NO. ISHR-T100-U\*\*

DATA  
OUTPUT

FORCE LOADING BY ELECTRIC  
MOTOR (WITHOUT WEIGHTS)

**INSPECTION  
CERTIFICATE**

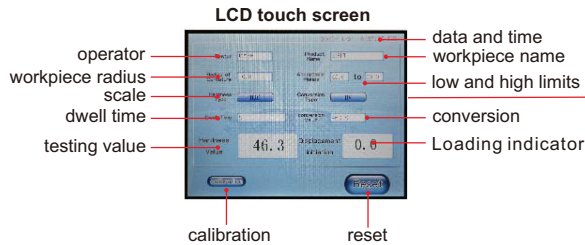

- Dolphin-nose indenter for easy reach interior of pipe and groove
- Automatic testing after preliminary test force is loaded by hand
- LCD touch screen, easy operation
- Convert to other Rockwell scales, HV or HB automatically
- Low and high limits
- Insert USB flash disk, save the testing results as Excel
- Self-compensation of the hardness value for curved workpiece
- Force loading by electric motor (without weights)
- The test force is selected automatically according to hardness scale



2.48" DIA flat anvil (included)



5.91" DIA flat anvil (included)



level (included)



touch pen (included)



V-type anvil (included) for cylinders with diameter .16~2.36" DIA



small V-type anvil (optional) for cylinders with diameter .08~.16" DIA

## SPECIFICATION

Hardness scale	HRA, HRB, HRC, HRD, HRF, HRG (with standard indenters)
	HRE, HRH, HRK, HRL, HRM, HRP, HRR, HRS, HRV (with optional indenter)
Preliminary test force	98N/10kgf
Test force	588N/60kgf, 980N/100kgf, 1471N/150kgf
Stage elevation	manual
Load control	automatic (load/dwell/unload)
Load dwell time	0~60 second
Resolution	.1HR
Output	USB
Max. workpiece height	11.81"
Max. workpiece depth	9.84" (from the center of indenter)
Power supply	110V, 50/60Hz**
Dimension	27.95×10.24×33.07"
Weight	177lb

## STANDARD DELIVERY

Main unit	1 pc
2.48" DIA flat anvil	1 pc
5.91" DIA flat anvil	1 pc
V-type anvil	1 pc
Diamond indenter	1 pc
1/16" carbide ball indenter	1 pc
Hardness test block HRB88~95	1 pc
Hardness test block HRC60~65	1 pc
Hardness test block HRC20~30	1 pc
USB flash disk (8G)	1 pc
Level	1 pc
Touch pen	1 pc
Anti-dust cover	1 pc

## OPTIONAL ACCESSORY

Hardness test block HRB88~95	ISH-BHRB
Hardness test block HRC60~65	ISH-BHRC3
Hardness test block HRC20~30	ISH-BHRC1
Small V-type anvil	ISH-SMALLANVIL



DATA  
OUTPUT

# AUTOMATIC DIGITAL ROCKWELL HARDNESS TESTER PART NO. ISH-MRD200-U\*\*

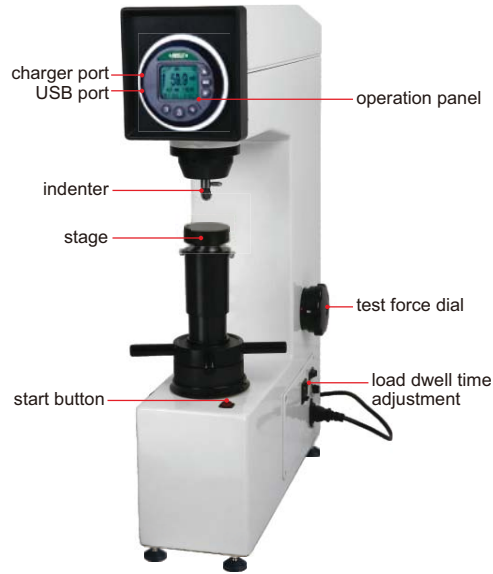
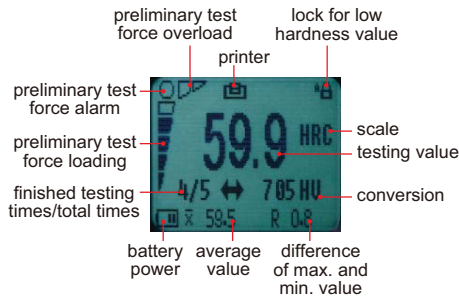

software CD (included)

- Low and high limits with alarm
- Set testing times (2~9) to have average value and the difference of max. and min. value
- Convert to HV or HB automatically
- Memory of 1000 testing values for browsing and output
- Testing value can be sent to wireless printer automatically
- Calibration function compensates the testing value for high accuracy
- The hardness value of soft materials like plastic is not stable. The lock function can obtain the value automatically
- Display unit is automatic power off



2.36" flat anvil (included)



5.91" DIA flat anvil (included)



V-type anvil (included) for cylinders with diameter .16~2.36 DIA



small V-type anvil (optional) for cylinders with diameter .08~.16 DIA



wireless printer (optional)

## SPECIFICATION

Hardness scale	HRA, HRB, HRC, HRD HRF, HRG (with standard indenters)
	HRE, HRH, HRK (with optional indenter)
Preliminary test force	98N/10kgf
Test force	588N/60kgf, 980N/100kgf, 1471N/150kgf
Stage elevation	manual
Load control	automatic (load/dwell/unload)
Load dwell time	1~99 second
Resolution	0.1HR
Output	wireless and USB
Memory	1000
Max. workpiece height	6.69"
Max. workpiece depth	6.50" (from the center of indenter)
Power supply of the display unit	built-in rechargeable battery
Power supply	110V, 50/60Hz **
Dimension	20.47×6.30×27.56"
Weight	132lb

## STANDARD DELIVERY

Main unit	1 pc
2.36" DIA flat anvil	1 pc
5.91" DIA flat anvil	1 pc
V-type anvil	1 pc
Diamond indenter	1 pc
1/16" DIA carbide ball indenter	1 pc
Hardness test block HRB88~95	1 pc
Hardness test block HRC60~65	1 pc
Hardness test block HRC20~30	1 pc
Anti-dust cover	1 pc
USB cable and software	1 pc
AC/DC adapter	1 pc

## OPTIONAL ACCESSORY

Wireless printer	ISH-DS-PRINTER
1/8" DIA carbide ball indenter	ISH-EHK-INDENTER
Hardness test block HRB88~95	ISH-BHRB
Hardness test block HRC60~65	ISH-BHRC3
Hardness test block HRC20~30	ISH-BHRC1
Small V-type anvil	ISH-SMALL ANVIL



## MANUAL DIGITAL ROCKWELL HARDNESS TESTER PART NO. ISH-RD200

- Low and high limits with alarm
- Set testing times (2~9) to have average value and the difference of max. and min. value
- Convert to HV or HB automatically
- Memory of 1000 testing values for browsing and output
- Testing value can be sent to wireless printer automatically
- Calibration function compensates the testing value for high accuracy
- The hardness value of soft materials like plastic is not stable. The lock function can obtain the value automatically
- Automatic power off

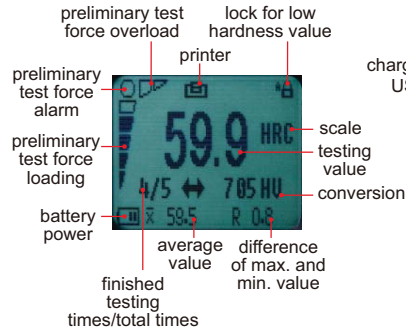

DATA OUTPUT

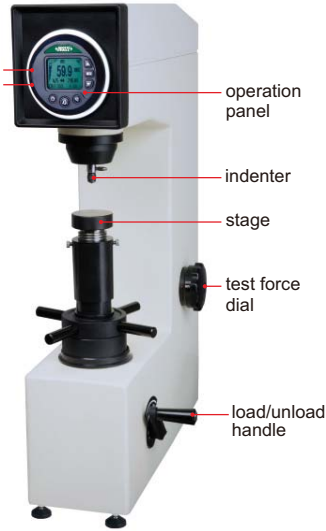

### SPECIFICATION

Hardness scale	HRA, HRB, HRC, HRD, HRF, HRG (with standard indenters)
	HRE, HRH, HRK (with optional indenter)
Preliminary test force	98N/10kgf
Test force	588N/60kgf, 980N/100kgf, 1471N/150kgf
Stage elevation	manual
Load control	manual
Resolution	0.1HR
Output	wireless and USB
Memory	1000
Max. workpiece height	6.69"
Max. workpiece depth	6.50" (from the center of indenter)
Power supply	built-in rechargeable battery
Dimension	20.47×6.30×27.56"
Weight	132lb



software CD (included)



VIDEO

### STANDARD DELIVERY

Main unit	1 pc
2.36" DIA flat anvil	1 pc
5.91" DIA flat anvil	1 pc
V-type anvil	1 pc
Diamond indenter	1 pc
1/16" DIA carbide ball indenter	1 pc
Hardness test block HRB88~95	1 pc
Hardness test block HRC60~65	1 pc
Hardness test block HRC20~30	1 pc
Anti-dust cover	1 pc
USB cable and software	1 pc
AC/DC adapter	1 pc

### OPTIONAL ACCESSORY

Wireless printer	ISH-DS-PRINTER
1/8" DIA carbide ball indenter	ISH-EHK-INDENTER
Hardness test block HRB88~95	ISH-BHRB
Hardness test block HRC60~65	ISH-BHRC3
Hardness test block HRC20~30	ISH-BHRC1
Small V-type anvil	ISH-SMALL ANVIL

## AUTOMATIC ROCKWELL HARDNESS TESTER PART NO. ISH-MR150-U\*\*



2.36" DIA flat anvil (included)



5.91" DIA flat anvil (included)



V-type anvil (included) for cylinders with diameter .16~2.36 DIA



small V-type anvil (optional) for cylinders with diameter .08~.16 DIA

### STANDARD DELIVERY

Main unit	1 pc
2.36" DIA flat anvil	1 pc
5.91" DIA flat anvil	1 pc
V-type anvil	1 pc
Diamond indenter	1 pc
1/16" DIA carbide ball indenter	1 pc
Hardness test block HRB88~95	1 pc
Hardness test block HRC60~65	1 pc
Hardness test block HRC20~30	1 pc
Anti-dust cover	1 pc

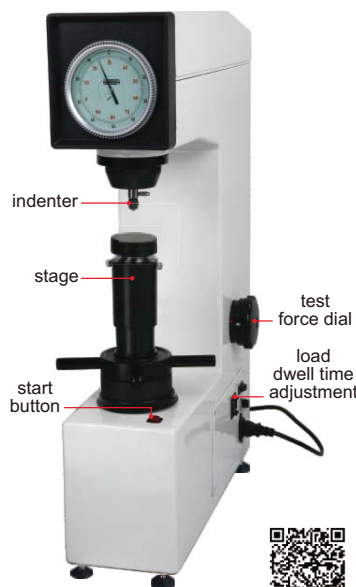

VIDEO

### SPECIFICATION

Hardness scale	HRA, HRB, HRC, HRD, HRF, HRG
Preliminary test force	98N/10kgf
Test force	588N/60kgf, 980N/100kgf, 1471N/150kgf
Display	analogue
Stage elevation	manual
Load control	automatic (load/dwell/unload)
Load dwell time	1~99 second
Min. reading	0.5HR
Max. workpiece height	6.69"
Max. workpiece depth	6.50" (from the center of indenter)
Power supply	110V, 50/60Hz **
Dimension	20.47×6.30×27.56"
Weight	132lb

### OPTIONAL ACCESSORY

Hardness test block HRB88~95	ISH-BHRB
Hardness test block HRC60~65	ISH-BHRC3
Hardness test block HRC20~30	ISH-BHRC1
Small V-type anvil	ISH-SMALL ANVIL



## MANUAL ROCKWELL HARDNESS TESTER PART NO. ISH-R150

### SPECIFICATION

Hardness scale	HRA, HRB, HRC, HRD, HRF, HRG
Preliminary test force	98N/10kgf
Test force	588N/60kgf, 980N/100kgf, 1471N/150kgf
Display	analogue
Stage elevation	manual
Load control	manual
Min. reading	0.5HR
Max. workpiece height	6.69"
Max. workpiece depth	6.50" (from the center of indenter)
Dimension	20.47×6.30×27.56"
Weight	132lb

### OPTIONAL ACCESSORY

Hardness test block HRB88-95	ISH-BHRB
Hardness test block HRC60-65	ISH-BHRC3
Hardness test block HRC20-30	ISH-BHRC1
Small V-type anvil	ISH-SMALL ANVIL

### STANDARD DELIVERY

Main unit	1 pc
2.36" DIA flat anvil	1 pc
5.91" DIA flat anvil	1 pc
V-type anvil	1 pc
Diamond indenter	1 pc
1/16" DIA carbide ball indenter	1 pc
Hardness test block HRB88-95	1 pc
Hardness test block HRC60-65	1 pc
Hardness test block HRC20-30	1 pc
Anti-dust cover	1 pc

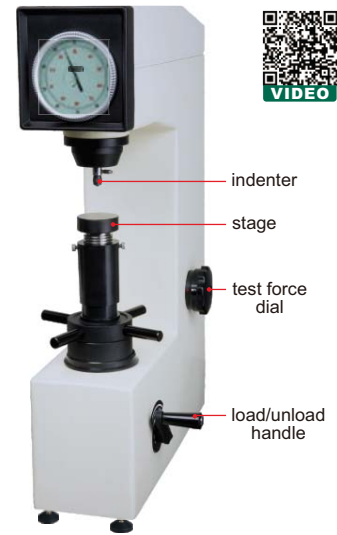

## BRINELL/ROCKWELL/VICKERS HARDNESS TESTER PART NO. ISH-BRV-U\*\*

### SPECIFICATION

Rockwell test load	98N/10kgf preload, 588N/60kgf, 980N/100kgf, 1471N/150kgf total load
Min. Rockwell reading	0.5HR
Brinell test load	306N/31kgf, 613N/62.5kgf, 1839N/187.5kgf
Vickers test load	294N/30kgf
Stage elevation	manual
Load control	manual
Magnification of microscope	37.5X/75X (selectable)
Max. workpiece height	7.09"
Max. workpiece depth	7.87" (from the center of indenter)
Power supply	110V, 50/60Hz **
Dimension	21.50×11.81×30.20"
Weight	198lb

### STANDARD DELIVERY

Main unit	1 pc
1/16" DIA carbide ball indenter	1 pc
Diamond Rockwell indenter	1 pc
.197" DIA Brinell indenter	1 pc
.098" DIA Brinell indenter	1 pc
Vickers indenter	1 pc
2.36" DIA flat anvil for Rockwell	1 pc
5.91" DIA flat anvil for Rockwell	1 pc
V-anvil for Rockwell	1 pc
2.36" DIA flat anvil for Vickers and Brinell	1 pc
V-type anvil for Vickers and Brinell	1 pc
Hardness test block HRB88-95	1 pc
Hardness test block HRC60-65	1 pc
Hardness test block HRC20-30	1 pc
Hardness test block 400-500HV30	1 pc
Hardness test block 180-200HBW2.5/187.5	1 pc
Anti-dust cover	1 pc

projection screen with scale for reading Rockwell hardness



microscope for Vickers and Brinell 15X eyepiece

graduation 0.01mm

objective 2.5X/5X

slider



### OPTIONAL ACCESSORY

Hardness test block HRB88-95	ISH-BHRB
Hardness test block HRC60-65	ISH-BHRC3
Hardness test block HRC20-30	ISH-BHRC1
Hardness test block 400-500HV30	ISH-BHV30
Hardness test block 180-220HBW2.5/187.5	ISH-BHB25B
Small V-type anvil	ISH-SMALL ANVIL

## AUTOMATIC BRINELL HARDNESS TESTER PART NO. ISHB-M100-U\*\*

AUTOMATIC TESTING AFTER PRELIMINARY  
TEST FORCE IS LOADED BY HAND

FORCE LOADING BY ELECTRIC  
MOTOR (WITHOUT WEIGHTS)

INSPECTION  
CERTIFICATE



- LCD touch screen, easy operation
- Automatic testing after preliminary test force is loaded by hand
- Measure indentation diameter by measuring microscope, input the diameters, the hardness value is shown on screen automatically
- Force loading by electric motor, without weights

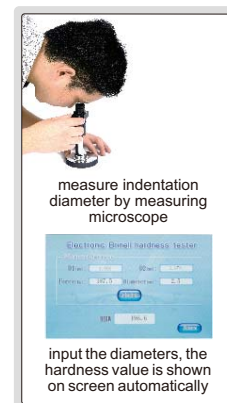

3.15" DIA flat anvil (included)



7.09" DIA flat anvil (included)



V-type anvil (included)



measuring microscope (included)

### SPECIFICATION

Range	8~650HBW	
Reading mode	directly read from LCD	
Test force	612.5N/62.5kgf, 980N/100kgf, 1.225kN/125kgf, 1.837kN/187.5kgf, 2.45kN/250kgf, 4.9kN/500kgf, 7.35kN/750kgf, 9.8kN/1000kgf, 14.7kN/1500kgf, 29.4kN/3000kgf	
Max. height of workpiece	9.05"	
Max. depth of workpiece	6.30" (from the center of indenter)	
Stage elevation	manual	
Load control	automatic (load/dwell/unload)	
Load dwell time	5~60 second	
Measuring microscope	magnification	20X
	graduation	0.01mm/.0004"
Power supply	110V, 50/60Hz **	
Dimension	21.65×8.27×29.53"	
Weight	198lb	

### STANDARD DELIVERY

Main unit	1 pc
3.15" DIA flat anvil	1 pc
7.09" DIA flat anvil	1 pc
V-type anvil	1 pc
.098" DIA carbide ball indenter	1 pc
.197" DIA carbide ball indenter	1 pc
.394" DIA carbide ball indenter	1 pc
Hardness test block 150~250HBW2.5/187.5	1 pc
Hardness test block 75~125HBW10/1000	1 pc
Hardness test block 175~250HBW10/3000	1 pc
Measuring microscope	1 pc
Anti-dust cover	1 pc

### OPTIONAL ACCESSORY

Hardness test block 150~250HBW2.5/187.5	ISH-BHB25B
Hardness test block 75~125HBW10/1000	ISH-BHB10A
Hardness test block 175~250HBW10/3000	ISH-BHB10B
Brinell indentation measuring system	ISHB-TSA/TSB

**AUTOMATIC TESTING AFTER PRELIMINARY TEST FORCE IS LOADED BY HAND**

## AUTOMATIC DIGITAL BRINELL HARDNESS TESTERS

**FORCE LOADING BY ELECTRIC MOTOR (WITHOUT WEIGHTS)**

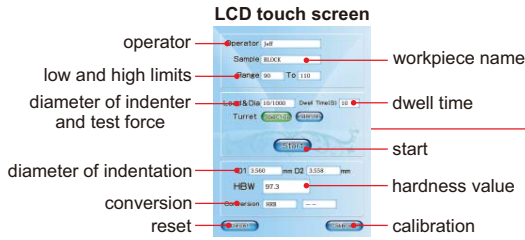
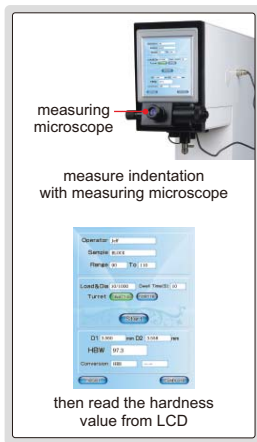

**ISHB-D200-U**



3.15" DIA flat anvil (included)



7.09" DIA flat anvil (included)



V-type anvil (included)



touch pen (included)

- Automatic testing after preliminary test force is loaded by hand
- LCD touch screen, easy operation
- Measure indentation by measuring microscope then read the hardness value from LCD
- Low and high limits
- Insert USB flash disk, save the test results as Excel
- Converted to HRA, HRB, HRC, HRD, HRF, HV, HB, HR15N, HR30N, HR45N, HR15T, HR30T, HR45T
- Force loading by electric motor, without weights

### SPECIFICATION

Part No.	ISHB-D200-U**	ISHB-D300-U**
Turret rotation	manual	automatic
Range	8~650HBW	
Reading mode	directly read from LCD	
Test force	612.5N/62.5kgf, 980N/100kgf, 1.225kN/125kgf, 1.837kN/187.5kgf, 2.45kN/250kgf, 4.9kN/500kgf, 7.35kN/750kgf, 9.8kN/1000kgf, 14.7kN/1500kgf, 29.4kN/3000kgf	
Max. height of workpiece	7.87"	
Max. depth of workpiece	6.1" (from the center of indenter)	
Stage elevation	manual	
Load control	automatic (load/dwell/unload)	
Load dwell time	5~60 second	
Measuring microscope	magnification	20X
	resolution	0.625mm/.0246"
Power supply	110V, 50/60Hz **	
Dimension	21.65×8.27×29.53"	
Weight	244lb	

### STANDARD DELIVERY

Main unit	1 pc
3.15" DIA flat anvil	1 pc
7.09" DIA flat anvil	1 pc
V-type anvil	1 pc
.098" DIA carbide ball indenter	1 pc
.197" DIA carbide ball indenter	1 pc
.394" DIA carbide ball indenter	1 pc
Hardness test block 150~250HBW2.5/187.5	1 pc
Hardness test block 75~125HBW10/1000	1 pc
Hardness test block 175~250HBW10/3000	1 pc
USB flash disk (8G)	1 pc
Touch pen	1 pc
Anti-dust cover	1 pc

### OPTIONAL ACCESSORY

Hardness test block 150~250HBW2.5/187.5	ISH-BHB25B
Hardness test block 75~125HBW10/1000	ISH-BHB10A
Hardness test block 175~250HBW10/3000	ISH-BHB10B
Brinell indentation measuring system	ISHB-TSA/TSB



## BRINELL INDENTATION MEASURING SYSTEM



software CD (included)



magnetic anvil

ISHB-TSA

application



VIDEO



- Connected to computer USB port
- Automatically measure the indentation
- Result saved to Excel automatically
- Low and high limits with judgement
- Calibration with indentation on standard hardness block

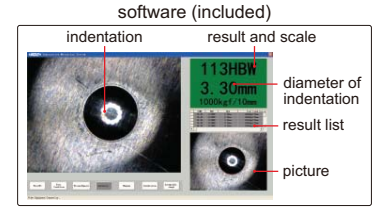

software (included)

indentation result and scale

diameter of indentation  
result list  
picture

### SPECIFICATION

Part No.	ISHB-TSA	ISHB-TSB
Applicable brinell indenter	Ø10mm/.394" DIA	Ø2.5mm/.098" DIA, Ø5mm/.197" DIA
Hardness range	8~650HB	
Range of indentation diameter	.094" DIA~.236" DIA	.024" DIA~.118" DIA
Test force	100, 250, 500, 1000, 1500, 3000kgf	62.5, 125, 187.5, 250, 750kgf
Hardness resolution	1HB	
Length resolution	0.01mm/.0004"	
Length accuracy	±1%(diameter of indentation)	
Camera	Sensor	1/3.2" CMOS
	Pixel	2M (resolution 1024x768)
	View field	.35x.27" .18x.13"
Dimension	6.69x2.13x2.13"	
Weight	.93lb	

### STANDARD DELIVERY

Main unit	1 pc
Software and dongle	1 pc of each

## AUTOMATIC DIGITAL MICRO-VICKERS HARDNESS TESTER PART NO. ISHV-D120-U\*\*

- Based on Vickers (HV), can be converted to HRA, HRB, HRC, HRD, HR15N, HR30N, HR45N, HR15T, HR30T, HR45T, HK, HBW
- Can take tests up to 99 times, display average value and the difference of max. and mini. value
- Low and high limits with judgement
- Also for Knoop hardness test, Knoop indenter is needed (optional)



slice holder (included)



vice (included)



level (included)



cylinder holder (included)

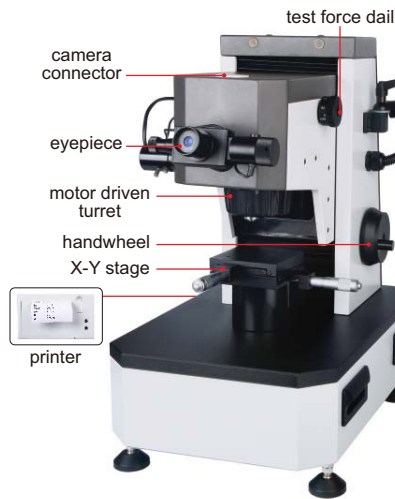

VIDEO

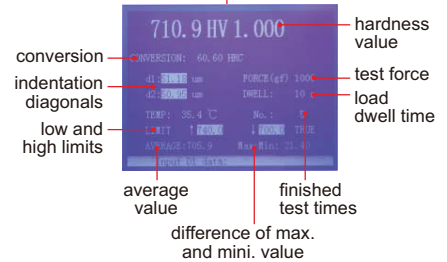

### SPECIFICATION

Range	10~3000HV	
Test force	0.098N/0.01kgf, 0.245N/0.025kgf, 0.49N/0.05kgf, 0.98N/0.1kgf, 1.96N/0.2kgf, 2.94N/0.3kgf, 4.9N/0.5kgf, 9.8N/1kgf	
Vickers scales	HV0.01, HV0.025, HV0.05, HV0.1, HV0.2, HV0.3, HV0.5, HV1	
Load control	automatic (load/dwell/unload)	
Load dwell time	0~60 second	
Eyepiece	magnification	10X
	resolution	0.01µm/.394µin (D≥10µm/394µin), 0.001µm/.039µin (D<10µm/394µin) D is diagonal length of indentation
Objective	10X, 40X	
Total magnification	100X (for observation), 400X (for measurement)	
Max. height of workpiece	8.27"	
Max. depth of workpiece	5.31" (from the center of indenter) dimension: 3.94x3.94", travel range: 1x1", graduation: 0.01mm/.0004"	
X-Y stage		
Power supply	110V, 50/60Hz**	
Dimension	19.29x12.60x20.87"	
Weight	99lb	

### STANDARD DELIVERY

Main unit	1 pc
Micro Vickers indenter	1 pc
Hardness test block (400~500HV0.2)	1 pc
Hardness test block (700~800HV1)	1 pc
Slice holder	1 pc
Vice	1 pc
Cylinder holder	1 pc
Level	1 pc
Anti-dust cover	1 pc

### OPTIONAL ACCESSORY

Hardness test block (400~500HV0.2)	ISH-BHV02A
Hardness test block (700~800HV1)	ISH-BHV1
Knoop indenter	ISHV-D120-KNOOP
Measuring system	9631-130
Camera adapter	ISHV-D120-ADAPTER



## DIGITAL VICKERS HARDNESS TESTERS

### SPECIFICATION

Part No.	ISH-DV5-U**	ISH-DV10-U**	ISH-DV50-U**
Measuring range	5HV0.2~2500HV5	8HV0.3~2500HV10	5HV1~2500HV50
Test force	0.2, 0.5, 1, 2, 3, 5kgf	0.3, 0.5, 1, 3, 5, 10kgf	1, 5, 10, 20, 30, 50kgf
Accuracy	±3%	±3%	±3% (test force 1, 5, 10, 20kgf) ±2% (test force 30, 50kgf)
Eyepiece	magnification	10X	10X
	resolution	0.0625µm/2.46µin	0.0625µm/2.46µin
Objective	10X, 20X	10X, 20X	10X
Total magnification	100X (for observation) 200X (for measuring)	100X (for observation) 200X (for measuring)	100X (for measuring)
Stage elevation	manual		
Load control	automatic (load/dwell/unload)		
Dwell time	5~60 second		
Max. workpiece height	6.30"		
Max. workpiece depth	5.31"		
Data output	RS232C		
Power supply	110V, 50/60Hz **		
Dimension	21.26×10.63×25.59"		
Weight	73lb	76lb	99lb

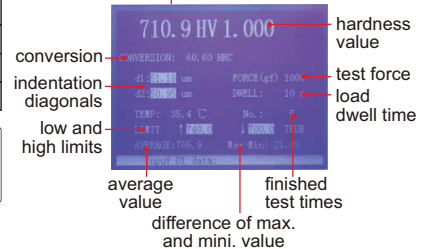

### STANDARD DELIVERY

Main unit	1 pc
2.36" DIA flat anvil	1 pc
5.91" DIA flat anvil	1 pc
V-type anvil	1 pc
Vickers indenter	1 pc
10X objective	1 pc
20X objective	1 pc (for ISH-DV5-U/ISH-DV10-U)
Vickers test block	2 pcs
Anti-dust cover	1 pc



### OPTIONAL ACCESSORY

Knoop indenter	ISH-KNOOP
Measuring system	9631-130
Hardness test block 400~500HV5	ISH-BHV5B
Hardness test block 650~750HV5	ISH-BHV5C
Hardness test block 400~500HV10	ISH-BHV10A
Hardness test block 650~750HV10	ISH-BHV10B
Hardness test block 400~500HV30	ISH-BHV30
Camera adapter	ISH-DV-ADAPTER

- Based on Vickers (HV), can be converted to HRA, HRB, HRC, HRD, HR15N, HR30N, HR45N, HR15T, HR30T, HR45T, HK, HBW
- Can take tests up to 99 times, display average value and the difference of max. and mini. value
- Low and high limits with judgement
- Also for Knoop hardness test, Knoop indenter is needed (optional)

- Connected to computer USB port
- Measure the indentation size automatically or manually
- Multiple measurements to have average value, max. value and min. value
- Low and high limits with judgement
- Convert to HRA, HRB, HRC, HRD, HRE, HRF, HRG, HRK, HR15T/30T/45T, HR15N/30N/45N, HK, HV, HB, HS, HSD
- Calibration with standard test block
- Measurement result can be exported to Word or Excel

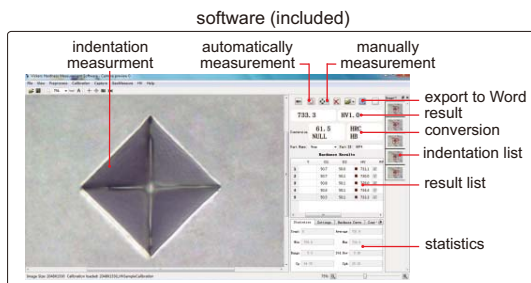

### STANDARD DELIVERY

Main unit	1 pc
USB dongle	1 pc
USB cable and software	1 pc



software CD (included)



## VICKERS HARDNESS MEASURING SYSTEM PART NO. 9631-130

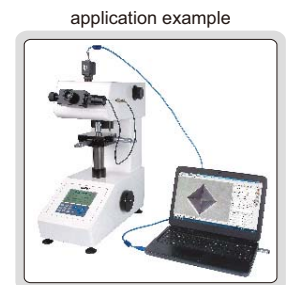
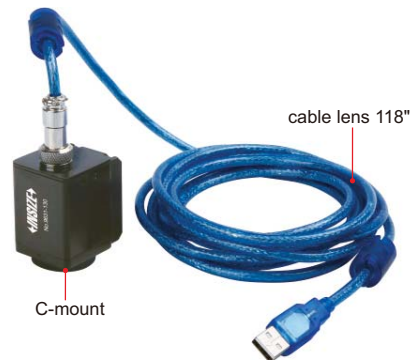

### SPECIFICATION

Sensor	1/2" CMOS
Pixel	1.3M (resolution1280×1024)
Hardness measurement resolution	0.1HV
Length measurement resolution	0.1µm/3.94µin
Hardness measurement accuracy	±3%
Test force	0.01, 0.025, 0.05, 0.1, 0.2, 0.3, 0.5, 1, 2, 2.5, 3, 5, 10, 20, 30, 50, 100kgf
Dimension	1.42×1.3×1.26"
Weight	1.11"

# PORTABLE LEEB HARDNESS TESTER PART NO. ISH-SPHA



- Based on Leeb (HL), converted to Vickers (HV), Brinell (HB), Rockwell (HRC and HRB), Shore (HS) and tensile strength (MPa)
- Connected with printer via bluetooth
- Connected with computer via USB port
- Up to 800 test results can be saved
- Low and high limits with judgement
- Touch screen operation, large display with backlight
- Language: English, Chinese, Italian, German, French and Portuguese
- Automatic power off
- According to ASTM A 956



software CD (included)



hardness test block D (included)



small support ring (included)



printer (included)

## SPECIFICATION

Min. reading	1HL, 1HV, 1HB, 0.1HRC, 0.1HRB, 1HS, 1MPa
Accuracy	±6HL (when HL=800)
Display	Leeb (HL), converted hardness, material, impact direction, test times, average value, deviation, time
Output	bluetooth and USB
Power supply	built-in rechargeable battery
Dimension	5.31×3.27×.94"
Weight	0.77lb

## STANDARD DELIVERY

Main unit	1 pc
Impact device D	1 pc
Printer	1 pc
Hardness test block D	1 pc
Small support ring	1 pc
Cleaning brush	1 pc
AC/DC adapter	1 pc
USB cable and software disc	1 pc
Pen for touch screen	1 pc

## OPTIONAL ACCESSORY

Impact device DC	ISH-SPHA-DC
Impact device C	ISH-SPHA-C
Impact device D+15	ISH-SPHA-D15
Impact device DL	ISH-SPHA-DL
Impact device G	ISH-SPHA-G
Hardness test block D*	ISH-BHLD
Hardness test block G*	ISH-BHLG
Couplant	ISH-COUPPLANT
Support rings	see details

\* Hardness test block G (ISH-BHLG) is for impact device G (ISH-SPHA-G).  
Hardness test block D (ISH-BHLD) is for all others impact devices.

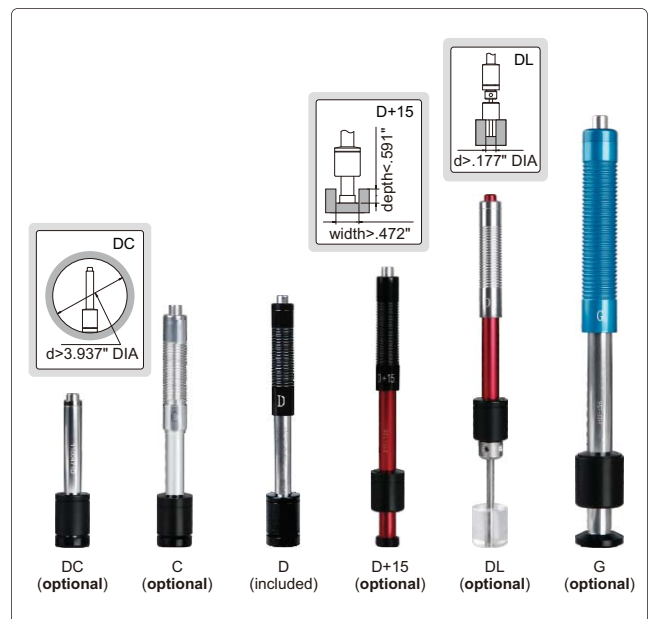

## APPLICABLE WORKPIECE

Impact device	DC	C	D	D+15	DL	G
Application	inner wall of small space	small or thin workpiece, coating layer	general use	deep groove	narrow slot or small hole	casting or forging workpiece
Maximum roughness of workpiece (Ra)	63µin	16µin	63µin	63µin	63µin	280µin
Minimum weight of workpiece	direct measurement	11.02lb	3.31lb	11.02lb	11.02lb	33.08lb
	on solid support	4.41lb	1.10lb	4.41lb	4.41lb	11.02lb
	coupled on plate	0.22lb	0.04lb	0.22lb	0.22lb	1.10lb
Minimum thickness of workpiece	.20"	.04"	.20"	.20"	.20"	.39"





## PORTABLE LEEB HARDNESS TESTER PART NO. ISH-PHB

### SPECIFICATION

Min. reading	1HLD, 1HV, 1HB, 0.1HRC, 0.1HRB, 1HS, 1MPa	
Accuracy	±6HLD (when HLD=800)	
Display	Leeb (HLD), converted hardness, material, impact direction, test times, average value, date	
Output	bluetooth	
Applicable workpiece	minimum weight	11.02lb
		4.41lb (on solid support)
		0.22lb (coupled on plate)
	minimum thickness	.20"
	minimum radius of curved surface:	1.18"
	maximum roughness (Ra):	63µin
Power supply	3×AAA batteries	
Dimension	5.91×3.31×1.10"	
Weight	0.44lb	



- Based on Leeb (HLD), converted to Vickers (HV), Brinell (HB), Rockwell (HRC and HRB), Shore (HS) and tensile strength (MPa)
- Memory of 99 measurement values for browsing
- Set measurement times (1~9) to have average value
- Connected with printer via bluetooth
- Automatic power off
- According to ASTM A 956

### STANDARD DELIVERY

Main unit	1 pc
Impact device D	1 pc
Hardness test block D	1 pc
Small support ring	1 pc
Cleaning brush	1 pc

### APPLICABLE MATERIAL AND HARDNESS RANGE FOR IMPACT DEVICE D

Material	HLD	HV	HB	HRC	HRB	HS	Tensile strength (MPa)
Steel & cast steel	300-900	81-955	81-654	20-68	38-100	32-100	375-2639
Tool steel	300-840	80-898		20-67			
Stainless steel	300-800	85-802	85-655		46-101		
Cast iron	360-650		93-334				
Cast aluminum alloy	170-570		19-164		23-84		
Brass	200-550		40-173		13-95		
Bronze	300-700		60-290				
Copper	200-690		45-315				

### OPTIONAL ACCESSORY

Wireless printer	ISH-DS-PRINTER
Couplant	ISH-COUPPLANT
Support rings	see details
Hardness test block D	ISH-BHLD



- Impact device D
- Based on Leeb (HLD), converted to Vickers (HV), Brinell (HB), Rockwell (HRC and HRB), Shore (HS) and tensile strength (MPa)
- Automatic direction correction
- Connected with printer via bluetooth
- Connected with computer via USB port
- Up to 500 test results can be saved
- According to ASTM A 956



## PORTABLE LEEB HARDNESS TESTER PART NO. ISH-SPHD

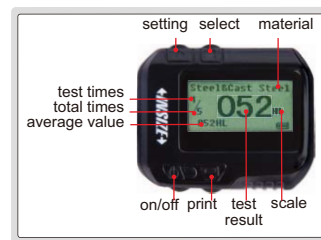

### SPECIFICATION

Min. reading	1HLD, 1HV, 1HB, 0.1HRC, 0.1HRB, 1HS	
Accuracy	±6HLD (when HLD=800)	
Output	USB and bluetooth	
Applicable workpiece	minimum weight	11.02lb (direct measurement)
		4.41lb (on solid support)
		0.22lb (coupled on plate)
	minimum thickness	.20"
	minimum radius of curved surface:	1.18"
	maximum roughness(Ra):	63µin
Power supply	built-in rechargeable battery	
Dimension	5.79×1.38×.87"	
Weight	0.14lb	

### STANDARD DELIVERY

Main unit	1 pc
Printer	1 pc
Hardness test block D	1 pc
Small support ring	1 pc
Cleaning brush	1 pc
AC/DC adapter	1 pc
USB cable and software disc	1 pc



### APPLICABLE MATERIAL AND HARDNESS RANGE FOR IMPACT DEVICE D

Material	HLD	HV	HB	HRC	HRB	HS
Steel & cast steel	300-900	81-955	81-654	20-68	38-100	32-100
Tool steel	300-840	80-898		20-67		
Stainless steel	300-800	85-802	85-655		46-101	
Cast iron	360-650		93-334			
Cast aluminum alloy	170-570		19-164		23-84	
Brass	200-550		40-173		13-95	
Bronze	300-700		60-290			
Copper	200-690		45-315			

### OPTIONAL ACCESSORY

Couplant	ISH-COUPPLANT
Support rings	see details
Hardness test block D	ISH-BHLD



## SUPPORT RING SET FOR PORTABLE LEEB HARDNESS TESTER PART NO. ISH-PH-SP9

type A

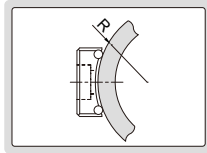

type B

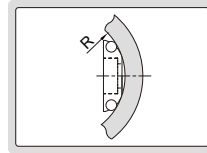

type C

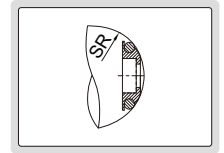

### SPECIFICATION

Type	Applicable workpiece	Range	Quantity
A	cylindrical outside surface	.394~.591"R	3 pcs
		.571~1.181"R	
		.984~1.969"R	
B	cylindrical inside surface	.433~.512"R	3 pcs
		.492~.669"R	
		.650~1.181"R	
C	spherical inside surface	.433~.512"SR	3 pcs
		.492~.669"SR	
		.650~1.181"SR	
D	spherical outside surface	.394~.591"SR	2 pcs
		.571~1.181"SR	
E	cylindrical outside surface	R>.394"	1 pc

type D

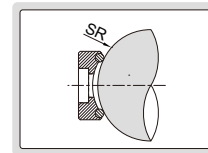

type E

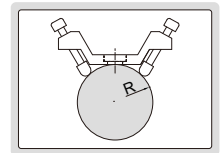

## DIGITAL MAGNETIC ROCKWELL HARDNESS TESTER PART NO. ISHR-D121



flat anvil for test block  
(included)



- Apply to large and heavy steel or iron workpieces
- With statistic function, display average, maximum and minimum values
- Convert to HV, HB and tensile strength
- According to ISO 6508, ASTM E18



### SPECIFICATION

Hardness scale	HRA, HRB, HRC
Preliminary test force	10kg
Test force	60kg, 100kg, 150kg
Load control	manual
Min. reading	0.1HR
Flat workpiece requirement	length>7.48", width>2.36", thickness>.20"
Cylinder or tube workpiece requirement	length>7.84", diameter>1.97" DIA, wall thickness>.31"
Power supply	3×AAA batteries
Dimension	9.65×4.13×9.06"
Weight	11.69lb

### STANDARD DELIVERY

Main unit	1 pc
Flat anvil	1 pc
Diamond indenter	1 pc
1/16" DIA carbide ball indenter	1 pc
Hardness test block HRB85~95	1 pc
Hardness test block HRC60~70	1 pc
Hardness test block HRC20~30	1 pc

## MAGNETIC ROCKWELL HARDNESS TESTER PART NO. ISHR-M111

- Apply to large and heavy steel or iron workpieces
- According to ISO 6508, ASTM E18



flat anvil for test block (included)



supports for cylinder or tube workpieces (included)



magnifier with LED (included)

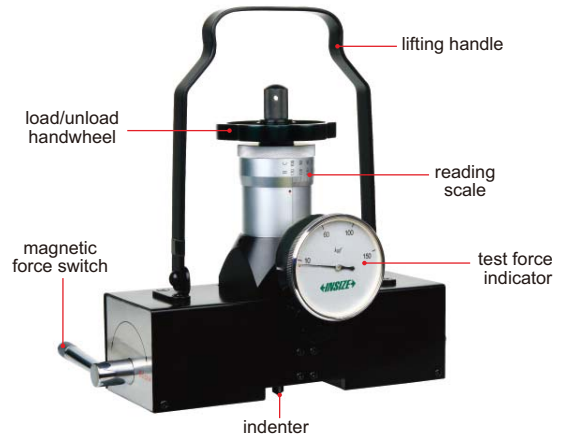

### SPECIFICATION

Hardness scale	HRA, HRB, HRC, HRD, HRF, HRG
Preliminary test force	10kg
Test force	60kg, 100kg, 150kg
Load control	manual
Min. reading	1HR
Flat workpiece requirement	length>7.09", width>2.36", thickness>.20"
Cylinder or tube workpiece requirement	length>7.09", diameter>1.97" DIA, wall thickness>.31"
Dimension	8.66×2.76×8.66"
Weight	10.36lb

### STANDARD DELIVERY

Main unit	1 pc
Diamond indenter	1 pc
1/16" DIA carbide ball indenter	2 pcs
Hardness test block HRB85~95	1 pc
Hardness test block HRC60~70	1 pc
Hardness test block HRC20~30	1 pc
Flat anvil	1 pc
Support	4 pcs
Magnifier with LED	1 pc

## MAGNETIC BRINELL/ROCKWELL HARDNESS TESTER PART NO. ISHR-B141

- Apply to large steel or iron workpieces
- According to ISO 6508, ASTM E18

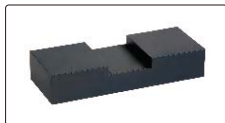

flat anvil for test block (included)



supports for cylinder or tube workpieces (included)



magnifier with LED (included)



measuring microscope (included)

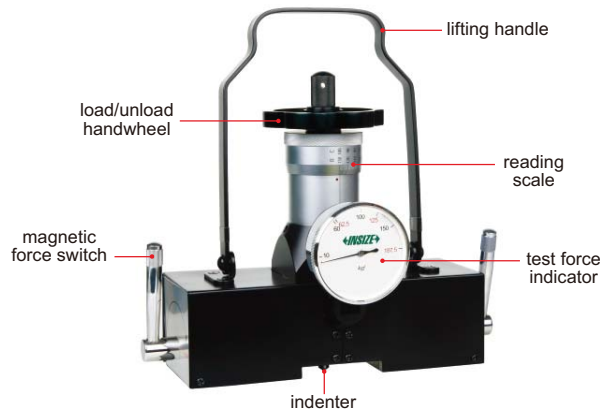

### SPECIFICATION

Rockwell scale	HRA, HRB, HRC, HRD, HRF, HRG
Brinell measuring range	20~650HBW
Rockwell test force	10kg preload, 60kg, 100kg, 150kg total load
Brinell test force	62.5kg, 125kg, 187.5kg
Load control	manual
Min. Rockwell reading	1HR
Measuring microscope	40X, graduation 0.01mm/.0004"
Flat workpiece requirement	length>7.09", width>2.36", thickness>.20"
Cylinder and tube workpiece requirement	length>7.09", diameter>1.97" DIA, thickness>.31"
Dimension	8.66×2.76×8.66"
Weight	10.36lb

### STANDARD DELIVERY

Main unit	1 pc
Flat anvil	1 pc
Support	4 pcs
Diamond Rockwell indenter	1 pc
1/16" DIA carbide ball indenter	1 pc
Ø2.5mm/.098" DIA Brinell indenter	1 pc
Hardness test block HRB85~95	1 pc
Hardness test block HRC60~70	1 pc
Hardness test block HRC20~30	1 pc
Brinell test block	1 pc
Measuring microscope	1 pc
Magnifier with LED	1 pc

## PORTABLE ROCKWELL HARDNESS TESTER PART NO. ISHR-P151

■ According to ISO 6508, ASTM E18

### SPECIFICATION

Hardness scale	HRA, HRB, HRC, HRD, HRF, HRG
Preliminary test force	10kg
Test force	60kg, 100kg, 150kg
Load control	manual
Min. reading	1HR
Max. workpiece thickness	.98"
Max. workpiece depth	.98"
Dimension	9.45×2.76×6.30"
Weight (with base)	5.51lb

### STANDARD DELIVERY

Main unit	1 pc
Diamond indenter	1 pc
1/16" DIA carbide ball indenter	2 pcs
Hardness test block HRB88~95	1 pc
Hardness test block HRC60~65	1 pc
Hardness test block HRC20~30	1 pc
Flat anvil	1 pc
V-type anvil	1 pc
Base	1 pc
Anvil extension	1 pc
Magnifier	2 pcs

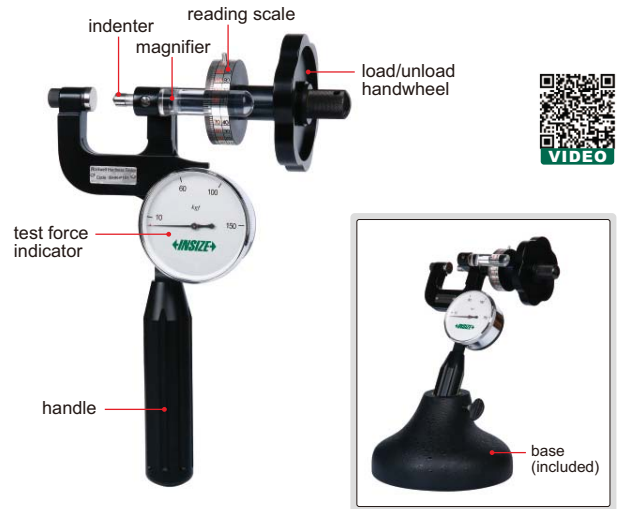

flat anvil (included)



V-type anvil (included)



anvil extension for thin workpieces (included)

## HYDRAULIC BRINELL HARDNESS TESTER PART NO. ISHB-H131

■ According to ISO 6506, ASTM E10



### SPECIFICATION

Measuring range	16~650HBW
Test force	3000kg
Indenter	Ø10mm/.394" DIA carbide ball
Measuring microscope	20X, graduation 0.01mm/.0004"
Max. workpiece height	13.78"
Max. workpiece depth	3.54" (from the center of indenter)
Dimension	10.63×8.86×22.44"
Weight	30.43lb

### STANDARD DELIVERY

Main unit	1 pc
Flat anvil	1 pc
V-type anvil	1 pc
Spherical anvil	1 pc
Ø10mm/.394" DIA carbide ball	2 pcs
Brinell test block	2 pcs
Measuring microscope	1 pc

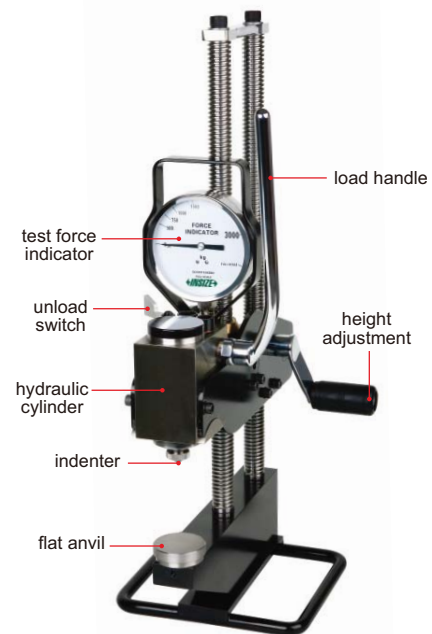

V-type anvil (included)



spherical anvil (included)



measuring microscope (included)

## CHAIN TYPE HYDRAULIC BRINELL HARDNESS TESTER PART NO. ISHB-C161

- To measure the hardness of cylinders or tubes
- According to ISO 6506, ASTM E10



### SPECIFICATION

Measuring range	32~650HBW
Workpiece diameter range	5.9~19.68" DIA
Test force	3000kg
Indenter	Ø10mm/.394" DIA carbide ball
Measuring microscope	20X, graduation 0.01mm/.0004"
Dimension	10.63×8.86×22.44"
Weight	32.22lb

### STANDARD DELIVERY

Main unit	1 pc
60" chain	1 pc
Ø10mm/.394" DIA carbide ball	2 pcs
Brinell test block	2 pcs
Measuring microscope	1 pc



measuring microscope (included)

## WEBSTER HARDNESS TESTERS

- To measure the hardness of soft metal such as aluminum alloy, copper, brass, soft steel, etc.
- According to ASTM B647-84 (2000)

### STANDARD DELIVERY

Main unit	1 pc
Spare indenter	1 pc
Hardness test block	1 pc
Wrench	1 pc



ISHW-L20

### SPECIFICATION

Part No.	ISHW-L20	ISHW-L20A	ISHW-L20B	ISHW-B70	ISHW-B75	ISHW-B92
Application	for aluminum alloy general use	for aluminum alloy thick workpiece	for aluminum alloy small tube	for hard aluminum alloy and hard brass	for soft brass and copper	for soft steel and cold-rolled steel
Thickness requirement of flat workpiece	.024~.23"	.024~.51"	.024~.31"	.024~.23"	.024~.23"	.024~.23"
Internal diameter requirement of tube workpiece	>.39" DIA	>.39" DIA	>.23" DIA	>.39" DIA	>.39" DIA	>.39" DIA
Wall thickness requirement of tube workpiece	.024~.23"	.024~.51" (internal diameter .39~.91" DIA) .024~.23" (internal diameter >.91" DIA)	.024~.31"	.024~.23"	.024~.23"	.024~.23"
Hardness range	0~20HW					
Min. reading	1HW					
Accuracy	±0.5HW (at 5~17HW)					
Dimension	8.07×1.18×3.35"					
Weight	1.10lb					



## BARCOL HARDNESS TESTER PART NO. ISHB-B300

- To measure the hardness of thick workpieces made of pure aluminum, aluminum alloy, fiber reinforced plastic, hard plastic, etc.
- According to ASTM B648-00, ASTM D2853-07



### SPECIFICATION

Hardness range	0~100HBa (equal to 25~150HBW)
Min. reading	1HBa
Accuracy	±2HBa (at 42~52HBa) ±1HBa (at 84~88HBa)
Min. workpiece thickness	.03"
Dimension	5.59×2.56×3.54"
Weight	1.10lb

### STANDARD DELIVERY

Main unit	1 pc
Spare indenter	2 pcs
Hardness test block	2 pcs
Wrench	1 pc

## DIGITAL SHORE DUROMETERS

DATA  
OUTPUT

- According to ISO868, ISO7619, ASTM D 2240
- Average and peak (max.) mode
- Dwell time is adjustable
- Low and high limits with judgement
- 500 memories
- Wireless connection to printer
- Handhold use or work with test stand (part no. ISH-DS-STAND)
- Automatic power off



### SPECIFICATION

Part No.	ISH-DSA	ISH-DSD
Unit	Shore A	Shore D
Test material	soft plastic, soft rubber, etc.	hard plastic, hard rubber, etc.
Measuring range*	0~100HA	0~100HD
Resolution	0.1HA	0.1HD
Accuracy	±1HA	±1HD
Indenter protrusion	.10"	
Output	wireless and USB	
Power supply	built-in rechargeable battery	
Dimension	6.02×1.97×1.14"	
Weight	.37lb	

- \* Use ISH-DSD when measuring result is higher than 90HA  
Use ISH-DSA when measuring result is lower than 20HD

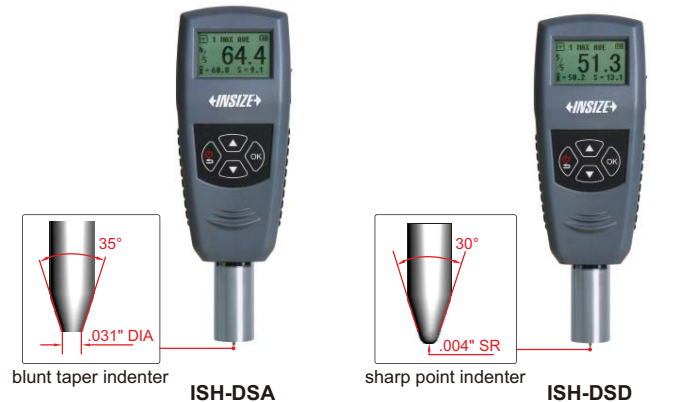

software CD (included)

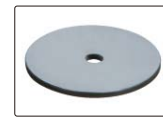

calibration block (included)



printer (optional)

### STANDARD DELIVERY

Main unit	1 pc
Calibration block	1 pc
USB cable and software	1 pc
AC/DC adapter	1 pc

### OPTIONAL ACCESSORY

Printer	ISH-DS-PRINTER
Test stand	ISH-DS-STAND
2.2lb weight block (for ISH-DSA)	ISH-DSA-W1
11lb weight block (for ISH-DSD)	ISH-DSD-W5

## SHORE DUROMETERS

- According to ISO868, ISO7619, ASTM D 2240
- With peak value indicator
- Optional accessory: test stand **ISH-STAC** and **ISH-STD**



### SPECIFICATION

Part No.	ISH-SAM	ISH-SDM
Scale	Shore A	Shore D
Application	nature rubber, soft elastomer, etc.	hard rubber, plastic, hard elastomer, etc.
Measuring range*	10~90HA	20~90HD
Graduation	1HA	1HD
Indenter protrusion	.10"	
Dimension	4.53×2.36×.98"	
Weight	.35lb	

- \* Use **ISH-SDM** when measuring result is higher than 90HA  
Use **ISH-SAM** when measuring result is lower than 20HD

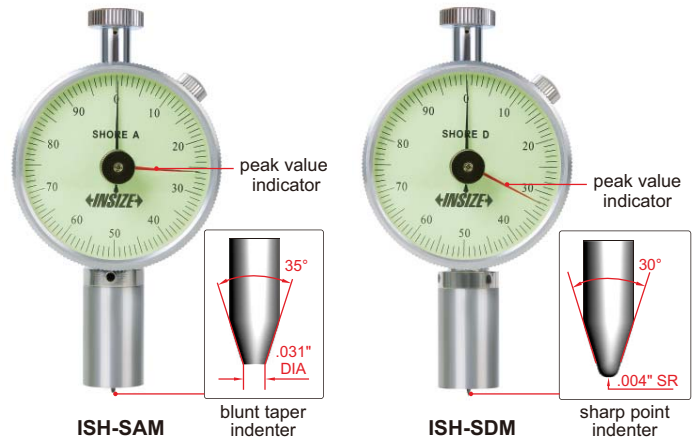

## TEST STANDS FOR SHORE DUROMETERS

- For shore durometers (part no. **ISH-SAM** and **ISH-SDM**)
- Perform repeatable hardness measurement due to fewer possibilities of human error or measurement variations



### SPECIFICATION

Part No.	ISH-STAC	ISH-STD
Applicable durometer	ISH-SAM	ISH-SDM
Stage diameter	3.94" DIA	3.94" DIA
Maximum workpiece height	2.95"	2.95"
Weight block	2.2lb	11lb

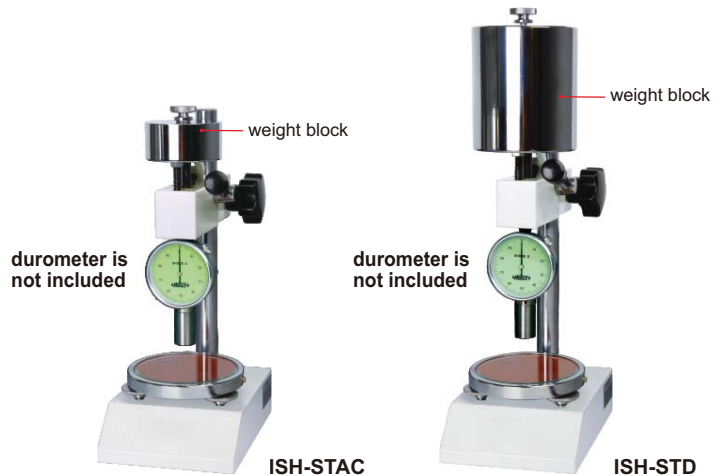

- Push and pull test
- Units: lbf, ozf, N, gf, kgf
- 500 memories
- Automatic power off
- Metal case
- LCD display with backlight
- The display flips over when the bottom faces up
- Overload alarm

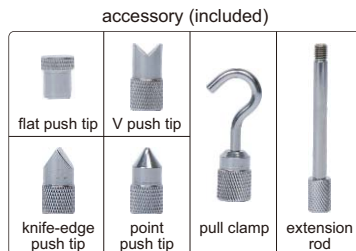

ISF-1DF100

## DIGITAL FORCE GAGES

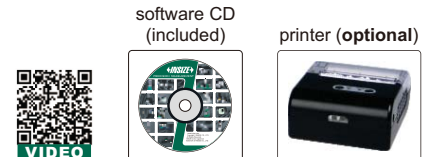

### STANDARD DELIVERY

Main unit	1 pc
AC/DC adapter	1 pc
USB cable and software	1 pc
Push/pull accessory	6 pcs (flat push tip, V push tip, knife-edge push tip, point push tip, pull clamp, extension rod)

### OPTIONAL ACCESSORY

Printer	ISF-DF-PRINTER
Test stand	ISF-MT1K

### SPECIFICATION

Part No.	ISF-1DF10	ISF-1DF50	ISF-1DF100	ISF-1DF500	ISF-1DF1000
Load capacity (lbf)	2.2	11	22	110	220
Resolution (lbf)	0.001	0.01	0.01	0.1	0.1
Accuracy	±0.3% (of load capacity)				
Measuring mode	tracking, peak (max.), low and high limits with judgement				
Power supply	built-in rechargeable battery				
Dimension	5.91×2.87×1.30"				
Weight	.99lb				

## DIGITAL FORCE GAGES (HIGH ACCURACY)

printer (optional)



software CD  
(included)



- Push and pull test
- Peak (max.) and tracking mode
- Units: lbf, ozf, mN, N, gf, kgf, MPa (only for type B)
- Low and high limits with judgement
- 1000 memories
- Automatic power off
- Metal case, touch buttons
- LCD display with backlight
- The display flips over when the bottom faces up
- Overload alarm



ISF-DF100A  
type A

ISF-DF5KA  
type B



VIDEO

INSPECTION  
CERTIFICATE

DATA  
OUTPUT

accessory for type A (included)

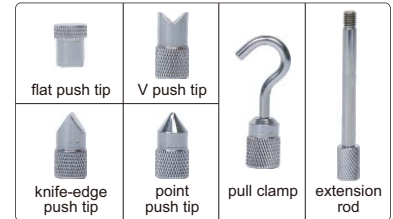

accessory for type B (included)



### SPECIFICATION

Part No.	ISF-DF 5A	ISF-DF 10A	ISF-DF 20A	ISF-DF 50A	ISF-DF 100A	ISF-DF 200A	ISF-DF 500A	ISF-DF 1KA	ISF-DF 2KA	ISF-DF 5KA	ISF-DF 10KA	ISF-DF 20KA
Type	A (internal sensor)								B (external sensor)			
Load capacity (lbf)	1.1	2.2	4.4	11	22	44	110	220	450	1100	2250	4500
Resolution (lbf)	0.0001	0.0005	0.001	0.001	0.005	0.01	0.01	0.05	0.1	0.1	0.5	1
Accuracy	±0.2% (of load capacity)											
Power supply	built-in rechargeable battery											

### STANDARD DELIVERY

Part No.	ISF-DF 5A	ISF-DF 10A	ISF-DF 20A	ISF-DF 50A	ISF-DF 100A	ISF-DF 200A	ISF-DF 500A	ISF-DF 1KA	ISF-DF 2KA	ISF-DF 5KA	ISF-DF 10KA	ISF-DF 20KA
Main unit	1 pc								1 pc			
AC/DC adapter	1 pc								1 pc			
USB cable and software	1 pc								1 pc			
Push/pull accessory	6 pcs (flat push tip, V push tip, knife-edge push tip, point push tip, pull clamp, extension rod)								4 pcs (flat push tip, adapter, pull clamps)			

### OPTIONAL ACCESSORY

Printer	ISF-DF-PRINTER
Test stand	ISF-MT1K

## TEST STAND FOR DIGITAL FORCE GAGES PART NO. ISF-MT1K



VIDEO

- For digital force gages (part no. ISF-1DFxx and ISF-DFxx)
- To be used in vertical and horizontal orientation



horizontal orientation test



digital scale (optional)

force gages are  
not included



### SPECIFICATION

Load capacity	220lbf
Travel	7.87" (.12" vertical movement per revolution of handwheel)
Dimension	7.72×9.84×17.56"
Weight	28.67lb

### OPTIONAL ACCESSORY

Digital scale (range: 8", resolution .0005"/0.01mm)	ISF-MT1K-SCALE
---	----------------

## DIAL TENSION GAGES

- Clockwise and counter-clockwise use
- For electronic and precision mechanical industry, such as measure contact pressure of relay, adjust the tension or compression of spring



ISF-TG3

### SPECIFICATION

Part No.	ISF-TGD1	ISF-TGD3	ISF-TGD5	ISF-TG1	ISF-TG1D5	ISF-TG3	ISF-TG5
Capacity (N)	0.1	0.3	0.5	1	1.5	3	5
Graduation (N)	0.002	0.005	0.01	0.02	0.025	0.05	0.1
Accuracy	±2% (full scale)						
Dimension (L×W×H)	3.54×1.85×.74"						
Weight	.13lb						

### DATA OUTPUT

## DIGITAL BOTTLE CAP TORQUE TESTERS

- Measure the open and tighten torque of bottle cap
- Units: lbf.in, lbf.ft, N.m, N.cm, kgf.cm
- 1500 memories
- Wireless connection to printer
- Automatic power off
- LCD display with backlight
- Overload alarm
- With calibration function



IST-DCT20

software CD (included)



printer (optional)



### SPECIFICATION

Part No.	IST-DCT2	IST-DCT5	IST-DCT10	IST-DCT20
Load capacity	17.7lbf.in	44.3lbf.in	88.5lbf.in	177lbf.in
	—	3.68lbf.ft	7.4lbf.ft	14.7lbf.ft
Resolution	0.01lbf.in	0.01lbf.in	0.05lbf.in	0.1lbf.in
	—	0.001lbf.ft	0.005lbf.ft	0.01lbf.ft
Clamping range	.77~7.48" DIA			
Accuracy	±0.5% (of load capacity)			
Measuring mode	tracking, peak (max.), first peak, double peak, low and high limits with judgement			
Output	wireless and USB			
Power supply	built-in rechargeable battery			
Dimension	7.87×7.76×5.59"			
Weight	5.51lb			

### STANDARD DELIVERY

Main unit	1 pc
AC/DC adapter	1 pc
USB cable and software	1 pc

### OPTIONAL ACCESSORY

Printer	ISH-DS-PRINTER
---------	----------------

two display modes



digital mode



graph mode



## DIGITAL TORQUE TESTERS

**ATTENTION: NOT SUITABLE FOR ELECTRIC WRENCHES, IMPACT WRENCHES OR PNEUMATIC WRENCHES**

- With external sensor, to test torque wrenches, torque screwdrivers and other torque tools
- Clockwise and counter-clockwise operation
- Peak, track and first peak working modes
- Unit: N.m, in.lb, ft.lb, kg.cm
- Low and high limits with judgement
- Target torque value can be set, with audible and visible alarm:
  - Green LED light on and buzzer sounds when the value is 80%~100% of target torque
  - Both green and red LED light on and buzzer sounds when the target torque value is reached
- Automatic power off

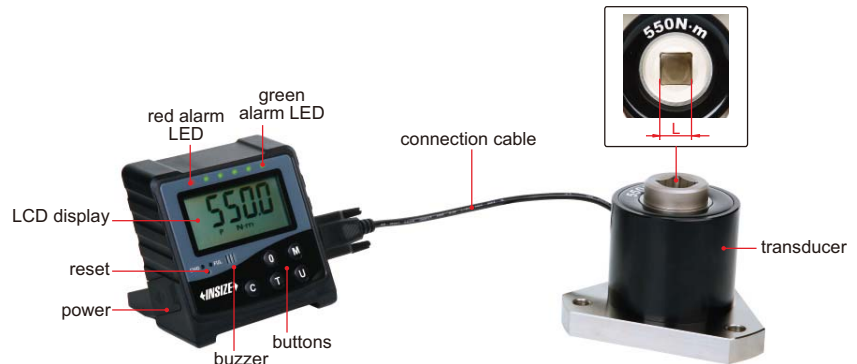

IST-TT550

### SPECIFICATION

Part No.	IST-TT5	IST-TT50	IST-TT220	IST-TT550	IST-TT2200
Range	4.42~44.24in.lb	44.2~442.4in.lb	195~1946in.lb	487~4867in.lb	—
	0.369~3.687ft.lb	3.69~36.87ft.lb	16.2~162.2ft.lb	40.6~405.6ft.lb	162~1622ft.lb
Accuracy	±1% (clockwise and counter-clockwise)				
Resolution	0.01in.lb	0.1in.lb	1in.lb	1in.lb	—
	0.001ft.lb	0.01ft.lb	0.1ft.lb	0.1ft.lb	1ft.lb
Square socket (L)	1/4"	3/8"	1/2"	3/4"	1"
Power supply	DC				
Adaptor	no	3/8" to 1/4"	1/2" to 3/8" 3/8" to 1/4"	3/4" to 1/2" 1/2" to 3/8"	1" to 3/4" 3/4" to 1/2"
Transducer dimension	2.36×2.36×1.85"	3.50×3.50×2.56"	4.29×4.29×2.87"	5.51×5.51×3.82"	6.30×6.30×4.57"
Weight	1.54lb	2.43lb	3.09lb	6.17lb	10.36lb



adaptor (included)



with 3 mounting holes on the bottom

### STANDARD DELIVERY

Main unit	1 pc
Transducer with 40" cable	1 pc

AC/DC adapter	1 pc
Adaptor	refer to the left

## TORQUE WRENCH TEST STAND PART NO. IST-TS500

- Work with digital torque testers (IST-TT5, IST-TT50, IST-TT220, IST-TT550)



application example

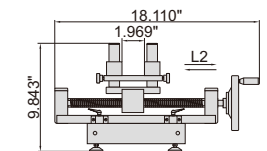
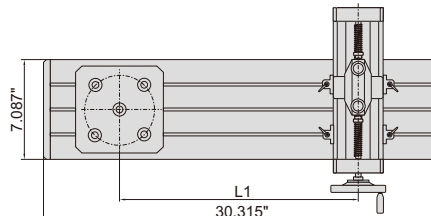

adaptor (optional, for digital torque tester IST-TT5, IST-TT50, IST-TT220)



digital torque tester (optional)

### SPECIFICATION

Digital torque tester	IST-TT5 (optional)	IST-TT50 (optional)	IST-TT220 (optional)	IST-TT550 (optional)
Applicable torque wrenches	4.42~44.24in.lb	44.2~442.4in.lb	195~1946in.lb	487~4867in.lb
	0.369~3.687ft.lb	3.69~36.87ft.lb	16.2~162.2ft.lb	40.6~405.6ft.lb
Arm length (L1)	5.91~24.41", adjustable			
Maximum travel (L2)	7.87"			
Weight	28.17lb			

### OPTIONAL ACCESSORY

Digital torque tester	IST-TT5, IST-TT50, IST-TT220, IST-TT550
Adaptor	IST-TS500-BLOCK (necessary for IST-TT5, IST-TT50 and IST-TT220, not needed for IST-TT550)



## DIGITAL TORQUE SCREWDRIVERS

- Clockwise and counter-clockwise operation
- Unit: in.lb, cN.m, kg.cm
- Peak and track working mode
- Target torque value can be set, with audible and visible alarm:
  - Green LED light on and buzzer sounds when target torque value is 90%~100% of target torque
  - Red LED light on and buzzer sounds when target torque value is reached
- Power off automatically in 5 minutes without any operations



IST-SD200

### SPECIFICATION

Part No.	IST-SD50	IST-SD200	IST-SD400
Range	0.88~4.42in.lb	3.54~17.7in.lb	7.08~35.39in.lb
Accuracy	clockwise	±3%	±2.5%
	counter-clockwise	±4%	±3.5%
Resolution	0.01in.lb	0.01in.lb	0.01in.lb
Size of hex socket (L)	1/4"	1/4"	1/4"
Power supply	1×AAA battery		
Length	7.60"	7.99"	7.99"
Weight	0.42lb	0.44lb	0.44lb



### OPTIONAL ACCESSORY

Calibration cable    IST-SD-CABLE



## SMALL RANGE DIGITAL TORQUE WRENCHES

- Clockwise and counter-clockwise operation
- Unit: in.lb, ft.lb, N.m, kg.cm
- Peak and track working mode
- Target torque value can be set, with audible and visible alarm:
  - Green LED light on and buzzer sounds when target torque value is 90%~100% of target torque
  - Red LED light on and buzzer sounds when target torque value is reached
- Power off automatically in 5 minutes without any operations
- Non-slip grip handle
- With overload record (once the torque reaches 110% of the maximum range)

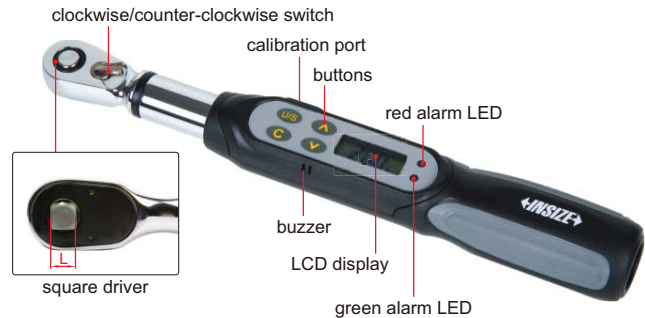

IST-WP20

### SPECIFICATION

Part No.	IST-WP6	IST-WP12	IST-WP20
Range	10.6~53.09in.lb 0.884~4.424ft.lb	21.2~106.2in.lb 1.77~8.85ft.lb	35.4~177.0in.lb 2.95~14.75ft.lb
Accuracy	clockwise	±3%	±3%
	counter-clockwise	±4%	±4%
Resolution	0.01in.lb	0.1in.lb	0.1in.lb
	0.001ft.lb	0.01ft.lb	0.01ft.lb
Square driver (L)	1/4"	1/4"	1/4"
Power supply	1×AAA battery		
Length	10.24"	10.24"	10.24"
Weight	0.95lb	0.95lb	0.95lb



### OPTIONAL ACCESSORY

Calibration cable    IST-SD-CABLE

## SHORT HANDLE DIGITAL TORQUE WRENCHES

- Clockwise and counter-clockwise operation
- Unit: in.lb, ft.lb, N.m, kg.cm
- Peak and track working mode
- Target torque value can be set, with audible and visible alarm:
  - Green LED light on and buzzer sounds when torque value is 90%~100% of target torque
  - Both green and red LED light on and buzzer sounds when target torque value is reached
- Power off in 5 minutes automatically
- Non-slip grip handle
- With damp record
- With overload record (once the torque reaches 110% of the maximum range)



**INSPECTION  
CERTIFICATE**



**IST-WS60**

### SPECIFICATION

Part No.	IST-WS30	IST-WS30A	IST-WS60	IST-WS85
Range	53.1~265.5in.lb	53.1~265.5in.lb	106.2~530.9in.lb	150~752in.lb
	4.42~22.12ft.lb	4.42~22.12ft.lb	8.85~44.24ft.lb	12.5~62.7ft.lb
Accuracy	clockwise	±3%		
	counter-clockwise	±4%		
Resolution	0.1in.lb	0.1in.lb	0.1in.lb	1in.lb
	0.01ft.lb	0.01ft.lb	0.01ft.lb	0.1ft.lb
Square driver (L)	1/4"	3/8"	3/8"	3/8"
Power supply	2×AAA batteries			
Length	8.46"	8.46"	8.86"	10.67"
Weight	1.65lb	1.83lb	2.02lb	2.21lb

### OPTIONAL ACCESSORY

Calibration cable	IST-SD-CABLE
-------------------	--------------

## DIGITAL TORQUE WRENCHES

- Clockwise and counter-clockwise operation
- Unit: in.lb, ft.lb, N.m, kg.cm
- Peak and track working mode
- Target torque value can be set, with audible and visible alarm:
  - Green LED light on and buzzer sounds when torque value is 90%~100% of target torque
  - Both green and red LED light on and buzzer sounds when target torque value is reached
- Power off automatically in 5 minutes without any operations
- Non-slip grip handle
- With damp record
- With overload record (once the torque reaches 110% of the maximum range)

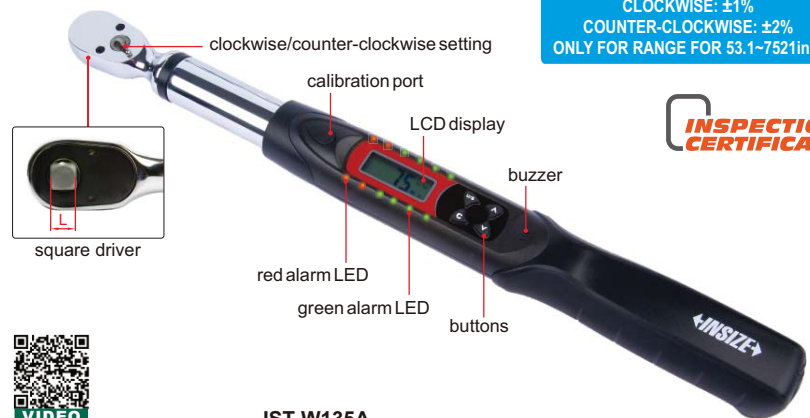

**OPTIONAL ACCURACY:**  
CLOCKWISE: ±1%  
COUNTER-CLOCKWISE: ±2%  
ONLY FOR RANGE FOR 53.1~752in.lb

**INSPECTION  
CERTIFICATE**



**IST-W135A**

### SPECIFICATION

Part No.	Range		Accuracy	Resolution		Square driver (L)	Power supply	Length	Weight
IST-W30A	53.1~265.5in.lb	4.42~22.12ft.lb	clockwise: ±2% counter-clockwise: ±3%	0.1in.lb	0.01ft.lb	1/4"	2×AA batteries	15.35"	1.83lb
IST-W135A	239~1195in.lb	19.9~99.5ft.lb		1in.lb	0.1ft.lb	3/8"		16.34"	2.09lb
IST-W200A	354~1770in.lb	29.5~147.5ft.lb		1in.lb	0.1ft.lb	1/2"		20.87"	3.09lb
IST-W340A	602~3009in.lb	50.1~250.7ft.lb		1in.lb	0.1ft.lb	1/2"		25.59"	3.53lb
IST-W500A	885~4424in.lb	73.7~368.7ft.lb	clockwise: ±2.5% counter-clockwise: ±3.5%	1in.lb	0.1ft.lb	3/4"		37.40"	4.63lb
IST-W850A	1504~7521in.lb	125.4~626.8ft.lb		1in.lb	0.1ft.lb	3/4"		48.03"	5.62lb
IST-W1200A	—	177~885ft.lb		—	1ft.lb	1"		70.87"	28.67lb
IST-W1500A	—	221~1106ft.lb		—	1ft.lb	1"		70.87"	28.67lb
IST-W2000A	—	295~1476ft.lb		—	1ft.lb	1"		70.87"	30.87lb

### OPTIONAL ACCESSORY

Calibration cable	IST-W-CABLE
-------------------	-------------

OPTIONAL ACCURACY:  
CLOCKWISE: ±1%  
COUNTER-CLOCKWISE: ±2%

**INSPECTION  
CERTIFICATE**



**DIGITAL TORQUE WRENCH  
IST-3W135A**



**RECEIVER  
IST-3WREC**



- Wireless data transfer to computer
- Unit: in.lb, ft.lb, N.m, kg.cm
- Clockwise and counter-clockwise operation
- Peak and track working mode
- Can set tolerance with judgement in peak working mode
- 9 target torque values can be set, with audible and visible alarm:
  - Green LED light on and buzzer sounds when torque value is 80%~99.5% of target torque
  - Both green and red LED light on and buzzer sounds when torque value is over 99.5% of target torque
- Power off in 2 minutes automatically
- Non-slip grip handle
- With damp record
- With overload record (once the torque reaches 110% of the maximum range)

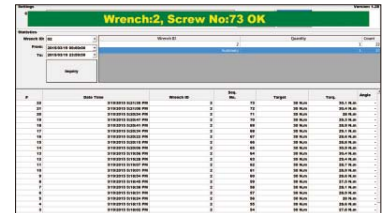

press "M" button to transfer data to computer when test value is within the tolerance

**DIGITAL TORQUE WRENCH SPECIFICATION**

Part No.	IST-3W30A	IST-3W135A	IST-3W200A	IST-3W340A
Range	53.1~265.5in.lb	239~1195in.lb	354~1770in.lb	602~3009in.lb
	4.42~22.12ft.lb	19.9~99.5ft.lb	29.5~147.5ft.lb	50.1~250.7ft.lb
Accuracy	clockwise	±2%		
	counter-clockwise	±3%		
Tolerance setting range	-25%~+25% (target torque value)			
Resolution	0.1in.lb	1in.lb	1in.lb	1in.lb
	0.01ft.lb	0.1ft.lb	0.1ft.lb	0.1ft.lb
Square driver (L)	1/4"	3/8"	1/2"	1/2"
Working frequency	ISM433MHz (432.0~433.8MHz, adjustable)			
Power supply	2xAA batteries, for 110 hours working			
Length	15.35"	16.34"	20.87"	25.59"
Weight	1.68lb	2.07lb	2.95lb	3.40lb

**RECEIVER SPECIFICATION**

Part No.	IST-3WREC
Working frequency	ISM433MHz (432.0~433.8MHz adjustable)
Power supply	DC 24V, 0.5A
Dimension	7.87×4.25×1.22"
Weight	1.10lb

**OPTIONAL ACCESSORY**

Calibration cable	IST-SD-CABLE
-------------------	--------------



## DIGITAL ANGLE TORQUE WRENCHES

- Clockwise and counter-clockwise operation
- Set the desired torque first. After reaching the desired torque, set the angle and turn the wrench at this angle to apply extra torque
- Unit: in.lb, ft.lb, N.m, kg.cm, degree
- Peak and track working mode
- Target torque or angle value can be set, with audible and visible alarm:
  - Green LED light on and buzzer sounds when torque or angle value is 90%~100% of target torque or angle
  - Both green and red LED light on and buzzer sounds when target torque or angle value is reached
- Power off in 5 minutes automatically
- Non-slip grip handle
- With damp record
- With overload record (once the torque reaches 110% of the maximum range)

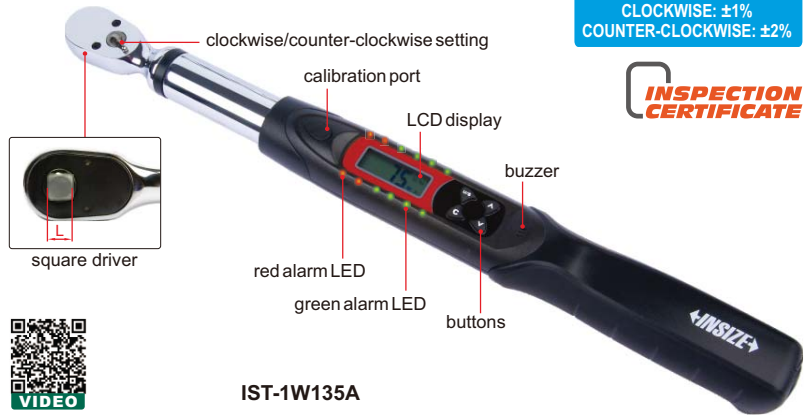

OPTIONAL ACCURACY:  
CLOCKWISE: ±1%  
COUNTER-CLOCKWISE: ±2%

**INSPECTION  
CERTIFICATE**



IST-1W135A

### SPECIFICATION

Part No.		IST-1W30A	IST-1W135A	IST-1W200A	IST-1W340A
Range	torque	53.1~265.5in.lb	239~1195in.lb	354~1770in.lb	602~3009in.lb
	angle	0~999°			
Accuracy	clockwise	±2%			
	counter-clockwise	±3%			
	angle	±2° (rotate 90°)			
Resolution	torque	0.1in.lb	1in.lb	1in.lb	1in.lb
	angle	1°			
Square driver (L)		1/4"	3/8"	1/2"	1/2"
Power supply		2xAA batteries, for 110 hours working			
Length		15.35"	16.34"	20.87"	25.59"
Weight		1.83lb	2.09lb	3.09lb	3.53lb



Set the desired torque first. After reaching the desired torque, set the angle and turn the wrench at this angle to apply extra torque

### OPTIONAL ACCESSORY

Calibration cable	IST-W-CABLE
-------------------	-------------

## QUALITY INSPECTION TORQUE WRENCHES

- Retighten the tightened bolt to measure the torque, read the torque value when the looseness is detected
- Two measuring modes:
  - M1: automatic detecting mode, for normal bolts. Retighten the tightened bolt, the torque value is displayed on screen when the wrench automatically detects the looseness, both green and red LED light on and buzzer sounds
  - M2: manual detecting mode, for long bolts. Retighten the tightened bolt, read the torque value when the looseness is detected by hand
- Unit: N.m, in.lb, ft.lb, kg.cm
- Peak and track working mode (only for M2 measuring mode)
- Clockwise and count-clockwise operation
- Memory of 50 results
- Power off in 15 minutes automatically
- Non-slip grip handle
- With overload record (once the torque reaches 110% of the maximum range)



MEASURE THE TORQUE  
OF TIGHTENED BOLT

OPTIONAL ACCURACY:  
CLOCKWISE: ±1%  
COUNTER-CLOCKWISE: ±2%

**INSPECTION  
CERTIFICATE**



IST-4W135A

### SPECIFICATION

Part No.		IST-4W30A	IST-4W135A	IST-4W200A	IST-4W340A
Range	torque	53.1~265.5in.lb	239~1195in.lb	354~1770in.lb	602~3009in.lb
	angle	0~999°			
Accuracy	clockwise	±2%			
	counter-clockwise	±3%			
Resolution	torque	0.1in.lb	1in.lb	1in.lb	1in.lb
	angle	1°			
Square driver (L)		1/4"	3/8"	1/2"	1/2"
Power supply		2xAA batteries, for 110 hours working			
Length		15.35"	16.34"	20.87"	25.59"
Weight		1.68lb	2.07lb	2.95lb	3.4lb



### OPTIONAL ACCESSORY

Calibration cable	IST-W-CABLE
-------------------	-------------

OPTIONAL ACCURACY:  
CLOCKWISE: ±1%  
COUNTER-CLOCKWISE: ±2%



## INTERCHANGEABLE HEAD DIGITAL TORQUE WRENCHES

- Clockwise and counter-clockwise operation
- Unit: in.lb, ft.lb, N.m, kg.cm
- Peak and track working mode
- Target torque value can be set, with audible and visible alarm:
  - Green LED light on and buzzer sounds when torque value is 90%~100% of target torque
  - Both green and red LED light on and buzzer sounds when target torque value is reached
- Power off in 5 minutes automatically without any operations
- Non-slip grip handle
- With damp record
- With overload record (once the torque reaches 110% of the maximum range)

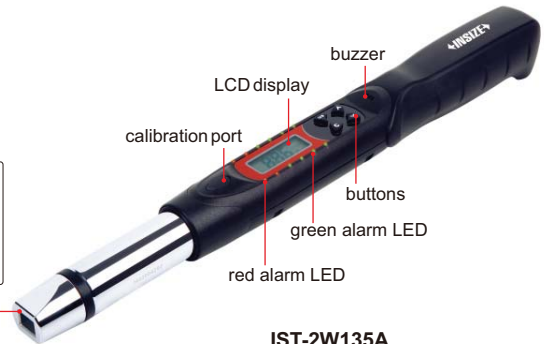
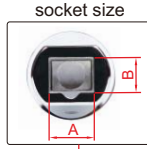

IST-2W135A

### SPECIFICATION

Part No.	IST-2W30A	IST-2W135A	IST-2W200A	IST-2W340A
Range	53.1~265.5in.lb	239~1195in.lb	354~1770in.lb	602~3009in.lb
	4.42~22.12ft.lb	19.9~99.5ft.lb	29.5~147.5ft.lb	50.1~250.7ft.lb
Accuracy	clockwise	±2%		
	counter-clockwise	±3%		
Resolution	0.1in.lb	1in.lb	1in.lb	1in.lb
	0.01ft.lb	0.1ft.lb	0.1ft.lb	0.1ft.lb
Socket size (A×B)	.47×.35"	.47×.35"	.71×.55"	.71×.55"
Arm length (L1)	10.74"	11.33"	15.00"	19.73"
Power supply	2xAA batteries, for 110 hours working			
Weight	3.09lb	3.46lb	4.78lb	5.12lb

### RATCHET HEAD (INCLUDED) SPECIFICATION

Part No. of torque wrench	IST-2W30A	IST-2W135A	IST-2W200A	IST-2W340A
Square driver (D)	1/4"	3/8"	1/2"	1/2"
Length (L2)	1.14"	1.14"	1.57"	1.57"

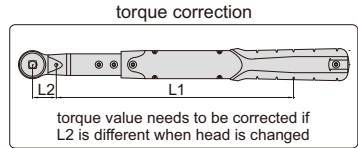
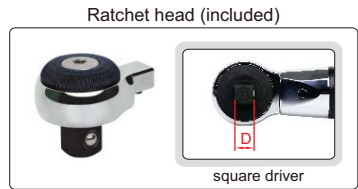

### STANDARD DELIVERY

Torque wrench	1 pc
Ratchet head	1 pc

### OPTIONAL ACCESSORY

Calibration cable	IST-W-CABLE
Interchangeable head	see details



### RATCHET HEAD (optional, additional)

Part No.	Square driver (D)	Applicable wrenches
IST-2W-R1	1/4"	IST-2W30A
IST-2W-R2	3/8"	IST-2W135A
IST-2W-R3	1/2"	IST-2W135A
IST-2W-R4	1/2"	IST-2W200A IST-2W340A

### BOX END HEAD (optional)

Part No.	Open size	Applicable wrenches
IST-2W-M1B	1/4"	IST-2W30A IST-2W135A
IST-2W-M5D	5/16"	
IST-2W-M3C	3/8"	
IST-2W-M7D	7/16"	
IST-2W-M1A	1/2"	
IST-2W-M9D	9/16"	
IST-2W-M5C	5/8"	
IST-2W-M11D	11/16"	
IST-2W-M3B	3/4"	
IST-2W-M13D	13/16"	
IST-2W-M7C	7/8"	

### OPEN END HEAD (optional)

Part No.	Open size	Applicable wrenches	
IST-2W-K1B	1/4"	IST-2W30A IST-2W135A	
IST-2W-K5D	5/16"		
IST-2W-K3C	3/8"		
IST-2W-K7D	7/16"		
IST-2W-K1A	1/2"		
IST-2W-K9D	9/16"		
IST-2W-K5C	5/8"		
IST-2W-K11D	11/16"		
IST-2W-K3B	3/4"		
IST-2W-2K1A	1/2"		IST-2W200A IST-2W340A
IST-2W-2K9D	9/16"		
IST-2W-2K5C	5/8"		
IST-2W-2K11D	11/16"		
IST-2W-2K3B	3/4"		
IST-2W-2K13D	13/16"		
IST-2W-2K7C	7/8"		
IST-2W-2K15D	15/16"		
IST-2W-2K1W	1"		
IST-2W-2K1F	1.1/8"		

### ADJUSTABLE SPANNER HEAD (optional)

Part No.	Open size	Applicable wrenches
IST-2W-A1	.20~1.06"	IST-2W135A
IST-2W-A2	.20~1.18"	IST-2W200A
IST-2W-A3	.39~1.61"	IST-2W340A



## CLASSIC TORQUE WRENCHES

LOUD CLICK SOUND

ACCURACY  $\pm 4\%$

INSPECTION CERTIFICATE



- Clockwise and counter-clockwise operation
- Unit: lbf.in, lbf.ft, N.m, kgf.m
- Loud click sound when target torque value is reached
- According to DIN ISO 6789, ASME B107.300-2010

IST-7WM135

### SPECIFICATION

Part No.		IST-7WM33	IST-7WM68	IST-7WM135	IST-7WM225	IST-7WM330	IST-7WM560	IST-7WM800	IST-7WM1000
Range	lbf.in	40~300	100~600	200~1200	400~2000	60~3000	120~5000	1800~7200	1800~8850
	lbf.ft	4~24	10~50	20~100	40~160	50~250	100~410	140~600	140~740
	N.m	5~33	12~68	25~135	50~225	70~330	140~560	200~800	200~1000
	kgf.m	.5~3.4	1.2~7	3~14	5~23	7~35	14~57	22~82	22~100
Accuracy		$\pm 4\%$	$\pm 4\%$	$\pm 4\%$	$\pm 4\%$	$\pm 4\%$	$\pm 4\%$	$\pm 4\%$	$\pm 4\%$
Graduation	lbf.in	10	20	50	50	100	100	200	200
	lbf.ft	1	2	2	5	10	10	20	20
	N.m	1	2	5	5	10	10	20	20
	kgf.m	.1	.2	1	1	1	1	2	2
Square driver (D)		1/4"	3/8"	1/2"	1/2"	1/2"	3/4"	3/4"	1"
Length		16.73"	19.68"	21.89"	23.62"	31.69"	39.21"	42.12"	55.12"
Weight		1.6lb	2.33lb	3.55lb	5.11lb	5.77lb	16.46lb	16.84lb	28.44lb

## TORQUE WRENCHES

INSPECTION CERTIFICATE

ATTENTION: CLOCKWISE OPERATION ONLY

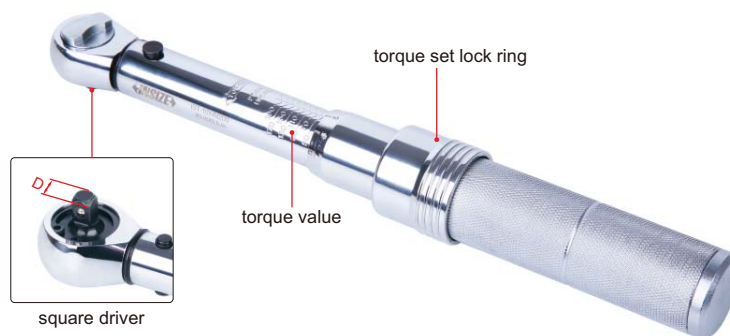

- According to DIN ISO 6789, ASME B107.300-2010
- All-metal construction

IST-10WM200

### SPECIFICATION

Part No.	IST-10WM200	IST-10WM250	IST-10WM100	IST-10WM150	IST-10WM250A	IST-10WM600
Range (clockwise)	40~200lb.in	50~250lb.in	20~100lb.ft	30~150lb.ft	50~250lb.ft	100~600lb.ft
Accuracy	$\pm 3\%$	$\pm 3\%$	$\pm 3\%$	$\pm 3\%$	$\pm 3\%$	$\pm 4\%$
Graduation	1lb.in	1lb.in	0.5lb.ft	0.5lb.ft	1lb.ft	2.5lb.ft
Square driver (D)	1/4"	3/8"	3/8"	1/2"	1/2"	3/4"
Length	11.02"	12.40"	16.73"	19.88"	20.67"	41.54"
Weight	1.50lb	1.81lb	2.29lb	2.56lb	2.87lb	13.01lb



ACCURACY  $\pm 3\%$



## DIAL TORQUE WRENCHES



IST-DW70

- Clockwise and counter-clockwise operation
- According to DIN ISO 6789, ASME B107.300

### SPECIFICATION

Part No.	IST-DW3D5	IST-DW9	IST-DW18	IST-DW35	IST-DW70	IST-DW140	IST-DW240	IST-DW350
Range	0.7~3.5N.m 6~30in.lb	1.8~9N.m 15~75in.lb	3.6~18N.m 30~150in.lb	7~35N.m 60~300in.lb	14~70N.m 120~600in.lb	28~140N.m 20~100ft.lb	48~240N.m 35~175ft.lb	70~350N.m 50~250ft.lb
Accuracy	$\pm 3\%$	$\pm 3\%$	$\pm 3\%$	$\pm 3\%$	$\pm 3\%$	$\pm 3\%$	$\pm 3\%$	$\pm 3\%$
Graduation	0.05N.m 0.5in.lb	0.1N.m 1in.lb	0.2N.m 2in.lb	0.5N.m 5in.lb	1N.m 10in.lb	2N.m 1ft.lb	3N.m 2.5ft.lb	2.5N.m 2.5ft.lb
Square driver (D)	1/4"	1/4"	3/8"	3/8"	3/8"	1/2"	1/2"	1/2"
Length	10"	10"	10"	10"	14.88"	21.5"	21.5"	21.5"
Weight	1.06lb	1.06lb	1.06lb	1.06lb	1.82lb	2.89lb	2.89lb	2.89lb



## DIGITAL TORQUE ADAPTERS

- Clockwise and counter-clockwise operation
- Set the desired torque first. After reaching the desired torque, set the angle and turn the wrench at this angle to apply extra torque
- Unit: N.m, in.lb, ft.lb, kg.cm, degree
- Peak and track working mode
- Target torque or angle value can be set, with audible and visible alarm:
  - Green LED light on and buzzer sounds when torque or angle value is 80%~100% of target torque or angle
  - Both green and red LED light on and buzzer sounds when target torque or angle value is reached
- Power off in 2 minutes automatically
- Memory 50 measurement values for browsing
- With overload record (once the torque reaches 110% of the maximum range)



IST-5W135A

### SPECIFICATION

Part No.	IST-5W30A	IST-5W135A	IST-5W200A	IST-5W340A	
Range	torque	53.1~265.5in.lb	239~1195in.lb	354~1770in.lb	602~3009in.lb
	angle	0~999°			
Accuracy	clockwise	$\pm 3\%$			
	counter-clockwise	$\pm 4\%$			
	angle	$\pm 2^\circ$ (rotate at 90°)			
Resolution	torque	.1in.lb	1in.lb	1in.lb	1in.lb
	angle	.01ft.lb	.1ft.lb	.1ft.lb	.1ft.lb
Square socket and driver	1/4"	3/8"	1/2"	1/2"	
Power supply	2xAAA batteries				
Length	3.35"DIA×2.36"	3.35"DIA×2.95"	3.35"DIA×3.15"	3.35"DIA×3.15"	
Weight	.33lb	.49lb	.53lb	.53lb	



### OPTIONAL ACCESSORY

Calibration cable	IST-SD-CABLE
-------------------	--------------



working with ordinary wrench



PART NO.	PAGE
<b>11</b>	
1102.....	4
1108.....	4
1110.....	5
1111.....	6
1114.....	4
1118.....	3
1119.....	4
1120.....	12
1121.....	13
1122.....	17
1123.....	15
1124.....	12
1125.....	10
1130.....	6
1131.....	7
1133.....	7
1135.....	7
1139.....	7
1140.....	24
1141.....	21
1142.....	22
1143.....	22
1144.....	23
1145.....	24
1146.....	30
1147.....	22
1148.....	23
1149.....	21
1150.....	28
1154.....	29
1156.....	28
1160.....	115
1161.....	18
1162.....	20
1163.....	92
1165.....	19
1166.....	122
1167.....	20
1168.....	21
1169.....	15
1172.....	19
1176.....	13
1177.....	16
1178.....	13
1179.....	18
1180.....	114

PART NO.	PAGE
1181.....	20
1183.....	15
1185.....	14
1186.....	17
1187.....	14
1188.....	15
1189.....	17
1192.....	16
1193.....	5
1196.....	5
<b>12</b>	
1205.....	8
1211.....	8
1250.....	29
1253.....	30
1267.....	114
<b>13</b>	
1311.....	8
1316.....	8
1351.....	29
<b>15</b>	
1520.....	14
1522.....	6
1523.....	6
1524.....	17
1525.....	16
1526.....	11
1527.....	18
1528.....	19
<b>21</b>	
2103.....	65
2104.....	65
2109.....	66
2112.....	64
2113.....	65
2114.....	64
2115.....	66
2117.....	67
2118.....	67
2121.....	86
2123.....	59
2124.....	50
2131.....	87
2132.....	87

PART NO.	PAGE
2141.....	26
2142.....	25
2151.....	86
2163.....	91
2164.....	92
2166.....	91
2167.....	91
2168.....	92
2170.....	181
2171.....	101
2172.....	103
2174.....	101
2175.....	180
2176.....	101
2179.....	180
2183.....	63
2186.....	90
2187.....	90
<b>22</b>	
2222.....	85
2277.....	122
2278.....	121
<b>23</b>	
2304.....	70
2307.....	70
2312.....	71
2315.....	69
2320.....	71
2323.....	59
2324.....	71
2326.....	72
2333.....	87
2341.....	25~26
2345.....	25
2363.....	89
2364.....	88
2365.....	88
2367.....	89
2372.....	103
2373.....	103
2374.....	102
2380.....	75
2381.....	75
2383.....	76
2385.....	135
2386.....	77

PART NO.	PAGE
2394.....	138
2395.....	61
2397.....	137
2398.....	76
2399.....	76
<b>24</b>	
2421.....	57
2422.....	58
2423.....	58
2425.....	58
2480.....	77
<b>28</b>	
2824.....	60
2827.....	60
2828.....	60
2832.....	68
2833.....	69
2834.....	75
2835.....	75
2836.....	68
2837.....	69
2839.....	68
2842.....	135
2843.....	174
2844.....	173
2871.....	88
2872.....	88
2873.....	89
2876.....	89
<b>29</b>	
2942.....	63
2944.....	114
<b>31</b>	
3101.....	31
3108.....	31
3109.....	32
3127.....	52
3128.....	53
<b>32</b>	
3203.....	33
3205.....	35
3206.....	34
3220.....	53



PART NO.	PAGE
3221.....	54
3222.....	55
3224.....	55
3225.....	55
3227.....	51
3228.....	53
3229.....	54
3230.....	38
3232.....	38
3233.....	40
3235.....	36
3236.....	32
3238.....	46
3239.....	42
3240.....	27
3241.....	27
3260.....	41
3261.....	40
3262.....	43
3263.....	46
3266.....	39
3280.....	44
3281.....	37
3282.....	46
3285.....	47
3287.....	36
3288.....	42
3290.....	44
3292.....	46
3293.....	47
3294.....	45
<b>33</b>	
3332.....	35
3334.....	91
<b>34</b>	
3400.....	32
<b>35</b>	
3506.....	34
3520.....	54
3530.....	38
3532.....	39
3533.....	40
3539.....	43
3540.....	27
3560.....	41

PART NO.	PAGE
3561.....	41
3562.....	43
3566.....	39
3580.....	45
3581.....	37
3588.....	42
3590.....	44
3594.....	45
<b>40</b>	
4001.....	97
4002.....	98
4003.....	133
4004.....	133
4005.....	93
<b>41</b>	
4102.....	93
4107.....	94
4109.....	98
4112.....	94
4120.....	100
4121.....	100
4130.....	99
4131.....	100
4141.....	104
4142.....	105
4144.....	104
4147.....	109
4162.....	98
4180.....	109
<b>42</b>	
4206.....	63
4208.....	62
4209.....	63
<b>46</b>	
4608.....	114
4630.....	115
4653.....	56
<b>47</b>	
4700.....	109
4701.....	107
4702.....	109
4706.....	108
4707.....	107

PART NO.	PAGE
4710.....	104
4721.....	84
4722.....	85
4726.....	84
4745.....	107
4747.....	107
4754.....	108
4760.....	108
4762.....	108
4770.....	104
4780.....	101
4781.....	102
4782.....	85
4786.....	84
4789.....	83
4790.....	105
4791.....	106
4792.....	106
4793.....	106
4794.....	105
4795.....	106
4797.....	102
4799.....	102
<b>48</b>	
4801.....	113
4804.....	113
4806.....	112
4807.....	112
4808.....	118
4809.....	119
4810.....	110
4812.....	111
4820.....	111
4824.....	111
4830.....	116
4831.....	116
4833.....	115
4835.....	117
4836.....	116
4837.....	115
4839.....	117
4842.....	118
4843.....	118
4844.....	113
4846.....	118
4852.....	116
4860.....	112

PART NO.	PAGE
<b>49</b>	
4901.....	182
4902.....	181
4905.....	182
4906.....	181
4907.....	182
4908.....	183
4909.....	183
4910.....	183
4911.....	184
4912.....	184
4913.....	184
4914.....	185
<b>50</b>	
5002.....	124
5003.....	124
5013.....	126
5022.....	123
5023.....	123
5031.....	124
5042.....	125
5051.....	125
5052.....	125
5062.....	125
5091.....	126
<b>61</b>	
6140.....	9
6141.....	24
6143.....	14
6144.....	9
<b>62</b>	
6200.....	79
6201.....	79
6202.....	79
6207.....	80
6208.....	78
6210.....	79
6211.....	81
6214.....	81
6215.....	80
6217.....	80
6224.....	81
6272.....	80
6282.....	73

PART NO.	PAGE
6284.....	77
6289.....	72
6291.....	78
6293.....	78
6294.....	136
6295.....	136
6296.....	78
<b>63</b>	
6300.....	47
6301.....	48
6311.....	48
6313.....	62
6315.....	47
6353.....	49
6354.....	49
6377.....	49
6381.....	49
<b>65</b>	
6521.....	134
6525.....	134
6526.....	134
6531.....	132
6532.....	132
6535.....	133
6547.....	133
6550.....	137
6566.....	136
6567.....	137
6569.....	137
<b>68</b>	
6801.....	131
6802.....	128
6803.....	128
6804.....	129
6862.....	83
6863.....	82
6864.....	82
6865.....	83
6866.....	81
6867.....	82
6881.....	96
6883.....	95
6884.....	95
6886.....	94
6887.....	129

PART NO.	PAGE
6888.....	130
6889.....	130
6890.....	131
6891.....	131
6892.....	132
6896.....	128
6897.....	129
6898.....	127
6899.....	132
<b>69</b>	
6900.....	126
6902.....	127
6903.....	127
6990.....	122
<b>71</b>	
7101.....	138
7102.....	139
7110.....	121
7113.....	120
7117.....	110
7118.....	110
7119.....	120
7126.....	121
7150.....	30
<b>72</b>	
7202.....	122
7230.....	122
7231.....	122
7232.....	122
7240.....	119
7241.....	119
7247.....	120
7251.....	123
7252.....	123
7253.....	123
7260.....	120
7261.....	119
7262.....	120
<b>73</b>	
7302.....	2
7304.....	2
7305.....	3
7306.....	2
7311.....	1

PART NO.	PAGE
7330.....	74
7331.....	74
7332.....	72
7341.....	99
7350.....	61
7351.....	61
7381.....	36
<b>75</b>	
7511.....	158
7512.....	159
7513.....	159
7514.....	159
7515.....	158
7516.....	160
<b>91</b>	
9110.....	176
<b>92</b>	
9221.....	178
9222.....	178
<b>93</b>	
9331.....	177
9341.....	177
9351.....	178
<b>95</b>	
9501.....	173
9561.....	176
<b>96</b>	
9631.....	195
<b>ISD</b>	
ISD-V150.....	144~145
ISD-V220CNC.....	145~146
ISD-V250.....	144~145
ISD-V270CNC.....	145~146
ISD-V300.....	144~145
ISD-V370CNC.....	145~146
<b>ISE</b>	
ISE-2DT.....	180
<b>ISF</b>	
ISF-1DFxxx.....	203

PART NO.	PAGE
ISF-DFxxx.....	204
ISF-MT1K.....	204
ISF-TGxxx.....	205
<b>ISH</b>	
ISH-BRV-U.....	191
ISH-DSA.....	202
ISH-DSD.....	202
ISH-DV10-U.....	195
ISH-DV50-U.....	195
ISH-DV5-U.....	195
ISH-MR150-U.....	190
ISH-MRD200-U.....	189
ISH-PHB.....	197
ISH-PH-SP9.....	198
ISH-R150.....	191
ISH-RD200.....	190
ISH-RSR400-U.....	185
ISH-RSR500-U.....	186
ISH-RSR600-U.....	187
ISH-SAM.....	203
ISH-SDM.....	203
ISH-SPHA.....	196
ISH-SPHD.....	197
ISH-STAC.....	203
ISH-STD.....	203
<b>ISHB</b>	
ISHB-B300.....	202
ISHB-C161.....	201
ISHB-D200-U.....	193
ISHB-D300-U.....	193
ISHB-H131.....	200
ISHB-M100-U.....	192
ISHB-TSA.....	194
ISHB-TSB.....	194
<b>ISHR</b>	
ISHR-B141.....	199
ISHR-D121.....	198
ISHR-M111.....	199
ISHR-P151.....	200
ISHR-T100-U.....	188
<b>ISHV</b>	
ISHV-D120-U.....	194
<b>ISHW</b>	



PART NO.	PAGE
ISHW-B70.....	201
ISHW-B75.....	201
ISHW-B92.....	201
ISHW-L20.....	201
ISHW-L20A.....	201
ISHW-L20B.....	201
<b>ISL</b>	
ISL-A1-xxx.....	140
ISL-A5-xxx.....	140
ISL-B5-xxx.....	140
ISL-DR2.....	139
ISL-DR3.....	139
<b>ISM</b>	
ISM-D500.....	157
ISM-DL200.....	147
ISM-DL300.....	148~149
ISM-DL301-U.....	148~149
ISM-DM40.....	150~151
ISM-M1000-U.....	157
ISM-M2000.....	155
ISM-M600-U.....	156
ISM-PM160LA.....	151~152
ISM-PM200SA.....	151~152
ISM-PM200SB.....	151~152

PART NO.	PAGE
ISM-PM600SA.....	151~152
ISM-PMxxx.....	158
ISM-TV200.....	154
ISM-TV200W.....	154
ISM-WF200.....	153~154
ISM-ZS30.....	156
ISM-ZS50.....	155
ISM-ZS50T.....	155
<b>ISO</b>	
ISO-2000FN.....	172
<b>ISP</b>	
ISP-Z3015.....	142~143
<b>ISQ</b>	
ISQ-DG6.....	179
ISQ-DG8.....	179
ISQ-PGS200.....	141~142
ISQ-RM30.....	179
<b>ISR</b>	
ISR-C002.....	165
ISR-C003.....	170
ISR-CS2E.....	170
ISR-CSE017.....	172

PART NO.	PAGE
ISR-CSE018.....	172
ISR-CSExxx.....	171
ISR-RSxxx.....	171
ISR-S1000B.....	166~167
ISR-S400.....	168~169
<b>IST</b>	
IST-1Wxxx.....	210
IST-2Wxxx.....	211
IST-3Wxxx.....	209
IST-4Wxxx.....	210
IST-5Wxxx.....	213
IST-7WMxxx.....	212
IST-10WMxxx.....	212
IST-DCTxxx.....	205
IST-DWxxx.....	213
IST-SD200.....	207
IST-SD400.....	207
IST-SD50.....	207
IST-TS500.....	206
IST-TTxxx.....	206
IST-WP12.....	207
IST-WP20.....	207
IST-WP6.....	207
IST-WSxxx.....	208
IST-Wxxx.....	208

PART NO.	PAGE
<b>ISU</b>	
ISU-100D.....	175
ISU-250C.....	175
ISU-300D.....	174
<b>ISV</b>	
ISV-1HLED.....	164
ISV-1Hxxx.....	163
ISV-1LED1.....	164
ISV-2CAM.....	164
ISV-2000D.....	161
ISV-2001D.....	161
ISV-2002D.....	161
ISV-3000D.....	161
ISV-3001D.....	161
ISV-3002D.....	161
ISV-4000D.....	160
ISV-4001D.....	160
ISV-5000D.....	160
ISV-5001D.....	160
ISV-E10.....	162
ISV-E20.....	162
ISV-RV.....	161
ISV-VP280.....	163



# APPLICATION INDEX

## HEIGHT

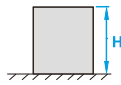

**Height Gages**  
(page 28-30)



**Dial Indicator Stands**  
6866-, 6867-, 6863-, 6864-, 6862-  
(page 81-83)



**Transfer Stand**  
6865-  
(page 83)



## DEPTH



**Depth Gages**  
1149-, 1141-, 1147-  
(page 21-22)



**Depth Gages With Point**  
1143- (page 22)

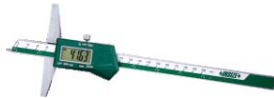
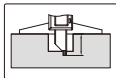

**Depth Gages With Hook**  
1142-, 1144-  
(page 22-23)

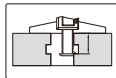
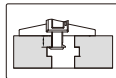

**Electronic Depth Gages With Round Depth Bar**  
1148-  
(page 23)

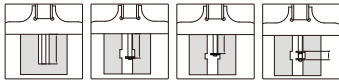

**Mini Depth Gages**  
1140-, 1145-  
(page 24)



**Dial/Electronic Depth Gages**  
2142-, 2341-, 2141-  
(page 25-26)



**Depth Micrometers**  
3540-, 3240-, 3241-  
(page 27)



**Electronic/Dial/Vernier Calipers With Depth Bar**  
(page 3-8)



## BORE DIAMETER

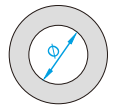

**Electronic/Dial/Vernier Calipers With Internal Measuring Jaws**  
(page 3-9)



**Universal Calipers**  
1125-  
(page 10)

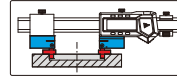

**Electronic Inside Knife-edge Calipers**  
1123- (page 15)

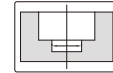

**Inside Micrometers**  
3220-, 3520-  
(page 53-54)



**Three Points Internal Micrometers**  
3227-, 3127-, 3228-, 3128-  
(page 51-53)



**Pistol Grip Three Points Bore Gages**  
2124-  
(page 50)



**Tubular Inside Micrometers**  
(page 54-55)



**Bore Plug Gages**  
4653-  
(page 56)



**Bore Gages**  
(page 59-61)



**Internal Caliper Gages**  
2222-, 2151-  
(page 85-86)



**Inside Spring Calipers**  
7261-, 7240-  
(page 119)



**Telescoping Gages**  
4208-, 4206-, 4209-  
(page 62-63)



**Taper Gages**  
4833-, 4837-  
(page 115)



**Taper Bore Gages**  
4852-  
(page 116)



**Pin Gages**  
4162-  
(page 98)



**Dial Snap Gages**  
2186-  
(page 90)



## DIAMETER OF BORE WITH CHAMFER

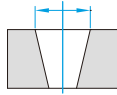

**Electronic Internal Chamfer Gages**  
2942-  
(page 63)

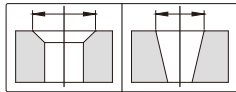

**Adjustable Snap Gages**  
2187-  
(page 90)



**Outside Micrometers**  
(page 31-35)



**External Caliper Gages**  
2333-, 2132-  
(page 87)



## ARC RADIUS

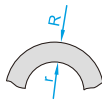

**Electronic Radius Gage**  
2183  
(page 63)

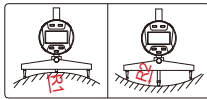

## DIAMETER OF GROOVE INSIDE HOLE



**Universal Calipers**  
1125-  
(page 10)

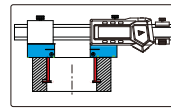

**Electronic Calipers With Interchangeable Points**  
1526-, 1124-  
(page 11-12)



**Electronic Arc Radius Calipers**  
1189-  
(page 17)

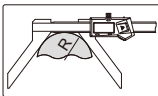

**Electronic Inside Groove Calipers**  
1120-, 1121-, 1176-, 1178-, 1520-  
(page 12-14)



**Radius Gages**  
4801-, 4804-  
(page 113)



## SHAFT DIAMETER

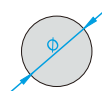

**Universal Calipers**  
1125-  
(page 10)

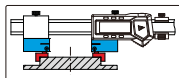

**Accessory Sets For Electronic Calipers**  
6144-  
(page 9)



**Internal Caliper Gages**  
2222-, 2151-  
(page 85-86)

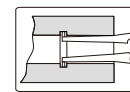

## WIDTH AND POSITION OF GROOVE INSIDE HOLE

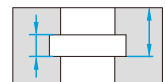

**Electronic/Dial/Vernier Calipers**  
(page 3-9)



**Electronic Hook Calipers**  
1122-  
(page 17)

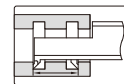

**Indicating Micrometers**  
3332-  
(page 35)



**Depth Gages With Hook**  
1142-, 1144-  
(page 22-23)

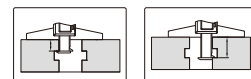

**Dial Snap Gages**  
3334-  
(page 91)



# APPLICATION INDEX

**Electronic Depth Gages With Round Depth Bar**  
1148- (page 23)

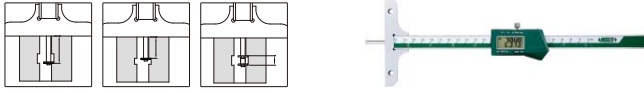

**Groove Micrometers**  
3287- (page 36)

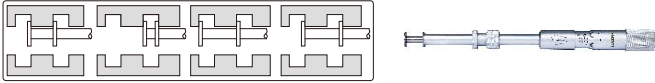

## EXTERNAL GROOVE DIAMETER

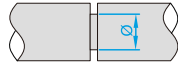

**Electronic Blade Calipers**  
1188- (page 15)



**Blade Micrometers**  
3232-, 3532- (page 38-39)



**Electronic Outside Neck Calipers**  
1187- (page 14)



**Electronic Calipers With Interchangeable Points**  
1526-, 1124- (page 11-12)



**Universal Calipers**  
1125- (page 10)



**External Caliper Gages**  
2333-, 2132- (page 87)



**Outside Calipers**  
7262-, 7241- (page 119-120)



## THICKNESS



**Thickness Gages**  
(page 88-89)



**Electronic Snap Gages**  
2166-, 2167-, 2163-, 1163- (page 91-92)



**External Caliper Gages**  
2333-, 2132- (page 87)



## TUBE WALL THICKNESS

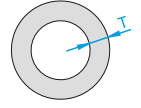

**Electronic Tube Thickness Calipers**  
1161- (page 18)



**Cylindrical Anvil Tube Micrometers**  
3261-, 3561- (page 40-41)



**Spherical Anvil Tube Micrometers**  
3260-, 3560- (page 41)



**Tube Thickness Gages**  
2876-, 2367- (page 89)

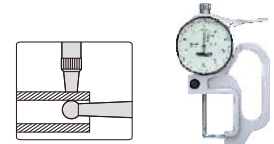

**Electronic Tube Thickness Gages**  
2873- (page 89)

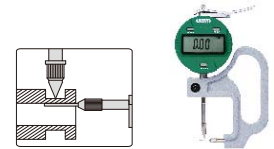

## CHAMFER

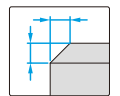

**Chamfer Gages**  
4844-, 1180-, 1267- (page 113-114)



**Electronic Chamfer Height Gage**  
2944- (page 114)



## SLOT WIDTH

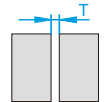

**Taper Gages**  
4630-, 1160 (page 115)



**Taper Gages**  
4833-, 4837- (page 115)



**Internal Caliper Gages**  
2222-, 2151-  
(page 85-86)



**Feeler Gages**  
4608  
(page 114)



**Step And Gap Gage**  
2168-  
(page 92)

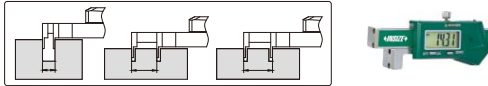

**Groove Micrometers**  
3287- (page 36)

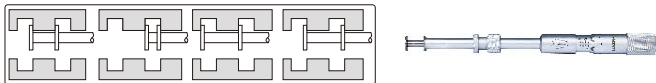

## HOLE CENTER-TO-CENTER AND CENTER-TO-EDGE DISTANCE

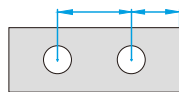

**Electronic Centering Calipers**  
1192-, 1177-, 1525-, 1524-  
(page 16-17)



**Universal Calipers**  
1125-  
(page 10)



**Accessory Sets For Electronic Calipers**  
6144-  
(page 9)



## ANGLE

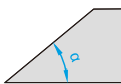

**Protractors**  
(page 101-102)



**Protractors**  
2374-, 2372-, 2373-, 2172-  
(page 102-103)



**Squares**  
4745-, 4747-, 4760-,  
4762-, 4706-, 4754-  
(page 107-108)



**Angle Gages**  
4806-, 4807  
(page 112)



**Angle Gage Blocks**  
4109-, 4002-  
(page 98)



**Electronic Levels And Protractors**  
2175-, 2179-, 2170-  
(page 180-181)

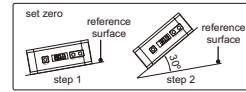

## SQUARENESS

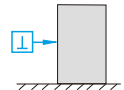

**Squares**  
4141-, 4144-, 4710-  
(page 104)



**Granite Squares With V Groove**  
4142-  
(page 105)



**Perpendicularity Testers**  
4770-  
(page 104)



**Squares**  
(page 105-107)



## STRAIGHTNESS AND FLATNESS

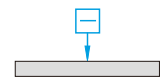

**Straight Edges**  
4700-, 4147-, 4180-,  
7117-, 7118-  
(page 109-110)



## COAXIALITY AND RUNOUT

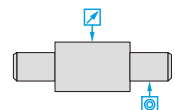

**Concentricity Gages**  
(page 83-84)



**Bench Centers**  
(page 84-85)





# APPLICATION INDEX

V-blocks  
(page 128-130)



Magnetic V-blocks  
(page 130-132)



## GEAR AND SPLINE



Electronic Gear Tooth Calipers  
1181-  
(page 20)

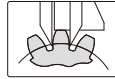

Disk Micrometers  
3282-, 3294-, 3594-  
(page 45-46)

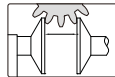

Universal Calipers  
1125- (page 10)

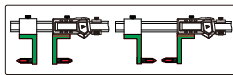

Electronic Calipers With  
Interchangeable Points  
1526-, 1124- (page 11-12)



## THREAD

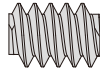

External Screw Thread Micrometers  
3281-, 3581-  
(page 37)

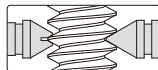

Thread Plug Gages  
(page 99-100)



Thread Ring Gages  
(page 100)



Pitch Gages  
4824-, 4820-  
(page 111)



Universal Calipers  
1125- (page 10)

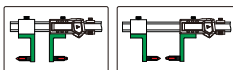

Electronic Calipers With Interchangeable Points  
1526-, 1124-  
(page 11-12)

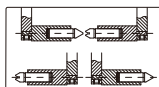



www.insizeus.com

TOLL FREE: 844-520-7668

ISO17025 CALIBRATION SERVICES

**INSIZE USA**  
3125 Medalist Drive  
Oshkosh, WI 54902  
(920) 426-5304 • Fax (920) 426-8120  
www.insizeus.com

CERTIFICATE OF CALIBRATION



<b>Certification Number</b> CI009-47588-322		<b>Procedures Followed</b> FVR012 rev. 0	
<b>For</b> INSIZE USA 3492 Diversified Dr Loganville, GA 30052		This certificate shall not be altered in any form or reproduced, except in full, without prior written approval from originating lab. These results relate only to the items calibrated. Form Revision 6. 02/04/2012	
<b>Purchase Order #</b> 4000620	<b>Test Instrument</b> Calipers Digital	<b>Standards Used</b>	<b>Serial Number</b> <b>Trace Number</b> <b>Next Cal</b>
<b>Make</b> INSIZE	<b>Model</b> 1108-300	FVR-005 N/A CE296-35292-343 12/28/2016	FVR-075 N/A CH137-30206-343 05/28/2016
<b>Serial Number</b> 1509171203	<b>Identification</b> 1509171203	FVR-096 N/A CH342-42961-328 12/08/2016	FVR-119 12072011 CH241-47026-287 08/26/2016
<b>Customer Location</b>		FVR-120 BRCS-120013 CF336-26669-406 01/28/2016	
<b>Condition Received</b> In Tolerance	<b>Condition Returned</b> In Tolerance	Total expanded measurement uncertainties expressed are based on a confidence level of 95% coverage factor of (k=2). The statement of compliance in this certificate was issued without taking the uncertainty of measurement into consideration. The customer shall assess the results and uncertainty when determining if the results meet their needs. (This is considered "shared responsibility.") Uncertainties expressed in nominal units.	
<b>Calibrated By</b> Andrew Drager	<b>Form Reviewed By</b> M.T.	All instruments have been calibrated against standards traceable to NIST. Calibration was completed in accordance with ISO/IEC 17025:2005 and ANSI Z540-1-1994.	
<b>Calibration Location</b> FVM	<b>Calibration Conditions</b> 71.7°F, 28.7%RH		
<b>Calibration Date</b> 01/09/2016	<b>Recalibration Due</b>		

**Calibration Results** \* denotes "Out of Tolerance"

Feature	Nominal	Lower Limit	Upper Limit	As Found	As Left	Uncertainty
OD Jaws	(in)	(in)	(in)	(in)	(in)	(in)
	0.3700	0.3690	0.3710	0.3700	0.3700	0.00039
	1.0000	0.9990	1.0010	1.0000	1.0000	0.00041
	1.8000	1.5990	1.6010	1.6000	1.6000	0.00042
	3.7500	3.7490	3.7510	3.7500	3.7500	0.00044
	6.0000	5.9990	6.0010	6.0000	6.0000	0.00047
12.0000	11.9990	12.0010	12.0000	12.0000	0.00056	
ID Jaws	(in)	(in)	(in)	(in)	(in)	(in)
	1.4000	1.3990	1.4010	1.4000	1.4000	0.00040
	2.0000	1.9990	2.0010	2.0000	2.0000	0.00042
Step	(in)	(in)	(in)	(in)	(in)	(in)
	1.0000	0.9990	1.0010	1.0005	1.0005	0.00041
Depth	(in)	(in)	(in)	(in)	(in)	(in)
	1.5000	0.9990	1.0010	1.0005	1.0005	0.00041

- INSIZE is proud to announce our calibration service "INSIZE Calibration Services".
- The most popular tools ready to ship same day!
- Tools ordered by noon will ship same day with an ISO17025 Certificate with date of service. No need to wait a week or more.
- All INSIZE precision tools available with ISO17025 certification. Contact us for pricing on all products.

Tools Available to Ship Today with Calibration Certificate

Part No.	Description
1108-150CAL	0-6"/0-150mm Electronic Caliper
1108-200CAL	0-8"/0-200mm Electronic Caliper
1108-300CAL	0-12"/0-300mm Electronic Caliper
1311-6CAL	0-6" Dial Caliper
1311-8CAL	0-8" Dial Caliper
1311-12CAL	0-12" Dial Caliper
3203-1ACAL	0-1" Outside Micrometer
3203-2ACAL	1-2" Outside Micrometer
2307-1CAL	0-1" Dial Indicator

Distributed by:



**INSIZE USA**  
Add: 3492 Diversified Drive  
Loganville, GA 30052  
Tel: 470-240-2520  
Fax: 470-448-4771  
E-mail: info@insizeus.com  
Website: www.insizeus.com