



Jacobs
CHUCK

Keyed Industrial Chucks 1244

Keyless Industrial Chucks..... 1248

Rubber-Flex® Collet Chucks 1250

Arbors..... 1252

Sleeves, Sockets & Ejecting Drifts .. 1255

Portable Tool Chucks 1256

Special Purpose Chucks 1258

Keys & Accessories 1258

Jacobs® Chucks

CHUCK

Jacobs® chucks, high precision tool holders, arbors, and related accessories have made Jacobs the leading brand of precision tool holding and work holding devices in the world. For more than 100 years, superior grip and accuracy have made Jacobs the industry leader, with Jacobs technology applied to everything from sophisticated CNC machining centers to cordless portable drills. Our commitment to excellence and innovation and continued investment in research and development provide us with the ability to maintain this leadership position.

HAND-TITE® KEYLESS CHUCKS



Split Bite Jaw increases grip over standard bite chucks by providing more contact with the bit

Precision Operation meets or exceeds stringent DIN run-out and dimensional specifications

Material and surface finish combinations result in increased comfort and performance

Anti-lock Nut prevents chuck from locking open

Hammerlock® positive locking mechanism prevents loosening in hammer and other high vibration applications

Provides high mechanical advantage to convert hand tightening torque into superior bit gripping force

Constructed of high performance material to maximize durability and performance

MULTI-CRAFT KEYED CHUCKS



Most popular chuck sold in the world

Constructed of high quality materials for lasting life and performance

Through-hardened jaws for hard, wear-resistant gripping surfaces

Time-tested design normally found only in industrial-grade chucks



NOMENCLATURE

Chucks and Keys

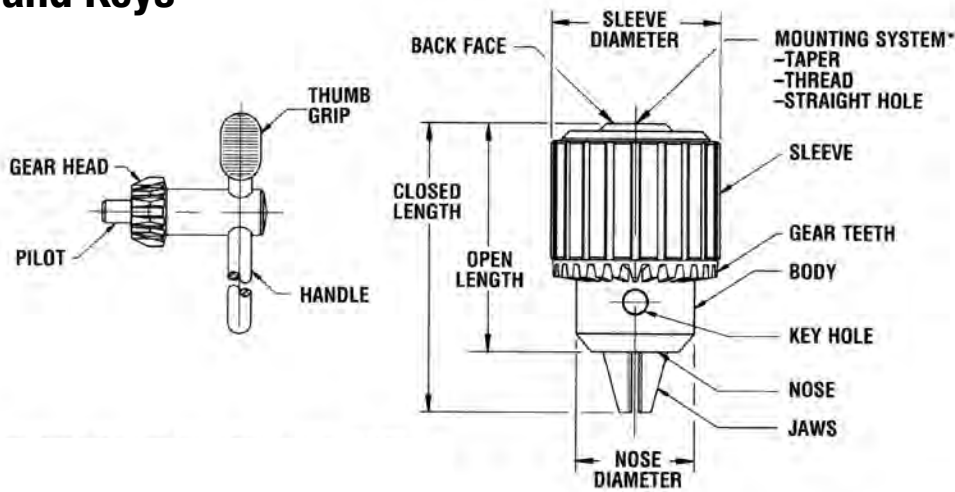

Tool Holders

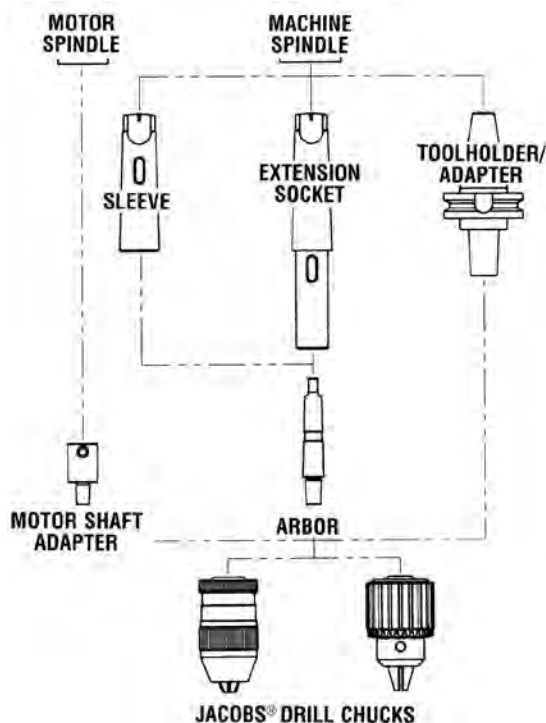

TOOL AND WORK HOLDER DEFINITIONS

ARBOR: Chuck mounting device used to adapt standardized chuck mounts to various machine spindle tapers. Arbors are also used to adapt mounts to other rotating devices such as machine spindles and lathes.

SLEEVE: Adapter for arbors when the machine spindle requires a larger taper than is available on the arbor.

EXTENSION SOCKET: Adapting device which increases effective spindle length and provides more flexibility when adapting to various taper sizes.

CENTERS: Support device for a workpiece when unusually long items or extreme accuracy are important. Available generally as rotating (“live”) and stationary (“dead”) designs.

Chuck and Accessory Removal Tools



REMOVAL TOOL DEFINITIONS

EJECTING DRIFT: Hardened steel accessory used to disassemble self-holding taper components.

WEDGES: Tapered steel plates used in pairs to disassemble chucks from arbors and spindles.

Jacobs® Ball Bearing - Taper Mount

- Ball Bearing Construction Maximizes Gripping Force and Drilling Accuracy
- Jaws Center-Ground for Straightness and Alignment
- One-Piece Sleeve Eliminates Crack Between Driving Teeth Often Found in Other Designs
- Through-Hardened Sleeve Teeth Plus Hardened Nose and Keyholes Provide Outstanding Wear Resistance
- Fluted Sleeve Standard
- Each Chuck 100% Inspected for Performance and Precision
- T.I.R. 0.003" Maximum at Half Capacity



Cat. No.	UPC No.	Packaging	Model No.	Min. Capacity	Max. Capacity	Mount	Key No.	Closed Length	Open Length	Sleeve Dia.	Product Weight	Shelf Pack Qty.
30209	095456302099	Boxed	8-1/2N	0.040 in	0.250 in	2SJT	K30	2.41 in	1.95 in	1.56 in	0.63 lb	1
30215	095456302150	Boxed	11N	0.040 in	0.375 in	2JT	K32	2.88 in	2.26 in	1.93 in	1.22 lb	1
30221D	095456302211	Boxed	14N	0.040 in	0.500 in	3JT	K3	3.88 in	2.97 in	2.44 in	2.44 lb	1
30227	095456302273	Boxed	16N	0.125 in	0.625 in	3JT	K4	4.31 in	3.26 in	2.63 in	3.20 lb	1
30233	095456302334	Boxed	18N	0.125 in	0.750 in	4JT	K4	5.12 in	3.95 in	3.01 in	4.56 lb	1
30239D	095456302396	Boxed	20N	0.375 in	1.000 in	5JT	K5	5.5 in	4.23 in	3.65 in	7.62 lb	1

Jacobs® Replacement Parts - Sleeves

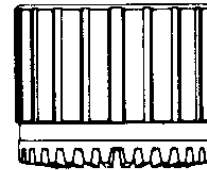

Cat. No.	UPC No.	Packaging	Description	Model No.	Product Weight	Shelf Pack Qty.
5089D	095456050891	Bagged	Replacement Sleeve for Model 8-1/2N	8-1/2N	0.20 lb	1
5097	095456050976	Bagged	Replacement Sleeve for Model 11N	11N	0.30 lb	1
5506D	095456055063	Bagged	Replacement Sleeve for Model 14N	14N	0.52 lb	1
5514D	095456055148	Bagged	Replacement Sleeve for Model 16N	16N	0.70 lb	1
5522D	095456055223	Bagged	Replacement Sleeve for Model 18N	18N	1.08 lb	1
5530D	095456055308	Bagged	Replacement Sleeve for Model 20N	20N	1.64 lb	1

Jacobs® Replacement Parts - Service Kits (Newer Models)

- For the New and Improved Jacobs Super Chuck® That Includes the Service Kit Number on the Chuck Nose
- Kit Includes Jaws, Nut, Caged Bearing, and Thrust Washer

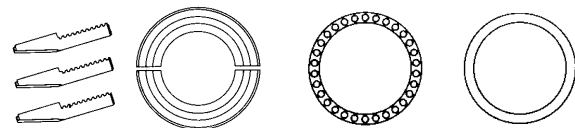

Cat. No.	UPC No.	Packaging	Description	Model No.	Product Weight	Shelf Pack Qty.
30343	095456303430	Bagged	Chuck Service Kit for Model 8-1/2N	8-1/2N	0.14 lb	1
30344	095456303447	Bagged	Chuck Service Kit for Model 11N	11N	0.20 lb	1
30345D	095456303454	Bagged	Chuck Service Kit for Model 14N	14N	0.45 lb	1
30346	095456303461	Bagged	Chuck Service Kit for Model 16N	16N	0.66 lb	1
30347	095456303478	Bagged	Chuck Service Kit for Model 18N	18N	0.90 lb	1
30348D	095456303485	Bagged	Chuck Service Kit for Model 20N	20N	1.68 lb	1

Jacobs® Replacement Parts - Service Kits (Older Models)

- For the Older Models Which Do Not Incorporate the Service Kit Marking on the Chuck Nose
- Kit Includes Jaws, Nut, Caged Bearing, and Thrust Washer

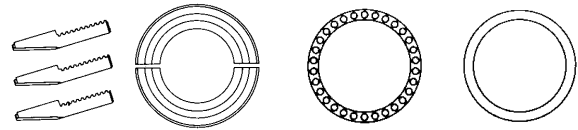

Cat. No.	UPC No.	Packaging	Description	Model No.	Product Weight	Shelf Pack Qty.
33416	095456334168	Bagged	Chuck Service Kit for Model 8-1/2N	8-1/2N	0.14 lb	1
33417	095456334175	Bagged	Chuck Service Kit for Model 11N	11N	0.20 lb	1
33418D	095456334182	Bagged	Chuck Service Kit for Model 14N	14N	0.45 lb	1
33419D	095456334199	Bagged	Chuck Service Kit for Model 16N	16N	0.66 lb	1
33420D	095456334205	Bagged	Chuck Service Kit for Model 18N	18N	0.90 lb	1
33421	095456334212	Bagged	Chuck Service Kit for Model 20N	20N	1.68 lb	1

Jacobs® Plain Bearing Taper Mounted - Heavy Duty Model

- Jaws Center-Ground for Absolute Straightness and Alignment
- One-Piece Sleeve Eliminates Crack Between Driving Teeth Often Found in Other Designs
- Through-Hardened Sleeve Teeth, Plus Hardened Nose and Keyholes Provide Outstanding Wear Resistance
- Each Chuck 100% Inspected for Performance and Precision
- T.I.R. .004" Maximum at Half Capacity
- KD Models Have Keyed Drive Feature
- PD Models Have Pin Drive Feature
- 34-33C Has Smooth Sleeve with Locking Collar



Cat. No.	UPC No.	Packaging	Model No.	Min. Capacity	Max. Capacity	Mount	Key No.	Closed Length	Open Length	Sleeve Dia.	Product Weight	Shelf Pack Qty.
6223	095456062238	Boxed	3A	0.125 in	0.625 in	3JT	K3	3.81 in	2.87 in	2.30 in	2.10 lb	1
6228	095456062283	Boxed	3KD	0.125 in	0.625 in	3JT	K3	4.06 in	3.12 in	2.29 in	2.20 lb	1
6230	095456062306	Boxed	3PD	0.125 in	0.625 in	3JT	K3	4.06 in	3.12 in	2.29 in	2.20 lb	1
14442	095456144422	Boxed	34-02	0.040 in	0.500 in	2JT	K3	3.52 in	2.74 in	2.04 in	1.75 lb	1
6295D	095456062955	Boxed	34-06	0.040 in	0.500 in	6JT	K3	3.52 in	2.74 in	2.04 in	1.70 lb	1
14445	095456144453	Boxed	34-33	0.040 in	0.500 in	33JT	K3	3.52 in	2.74 in	2.04 in	1.72 lb	1
14451	095456144514	Boxed	34-33C	0.040 in	0.500 in	33JT	K3C	3.71 in	2.93 in	2.00 in	1.63 lb	1
6309D	095456063099	Boxed	36	0.18 in	0.800 in	3JT	K4	4.06 in	3.14 in	2.54 in	3.02 lb	1

Jacobs® Taper Mounted - Medium Duty Model

- Jaws Center-Ground for Absolute Straightness and Alignment
- One-Piece Sleeve Eliminates Crack Between Driving Teeth Often Found in Other Designs
- Through-Hardened Sleeve Teeth, Plus Hardened Nose and Keyholes Provide Outstanding Wear Resistance
- Each Chuck 100% Inspected for Performance and Precision
- T.I.R. .004" Maximum at Half Capacity
- KD Models Have Keyed Drive Feature
- All Model 33 Plain Bearing Chucks are Hammer Capable.



Cat. No.	UPC No.	Packaging	Model No.	Min. Capacity	Max. Capacity	Mount	Key No.	Closed Length	Open Length	Sleeve Dia.	Product Weight	Shelf Pack Qty.
6200	095456062009	Boxed	0	0.0135 in	0.156 in	0JT	K0	1.404 in	1.100 in	0.850 in	0.18 lb	1
6206D	095456062061	Boxed	1A	0.040 in	0.250 in	1JT	K1	1.920 in	1.540 in	1.180 in	0.32 lb	1
33348	095456333482	Boxed	2	0.040 in	0.375 in	1JT	K2	2.490 in	2.010 in	1.420 in	0.95 lb	1
6214D	095456062146	Boxed	2A	0.040 in	0.375 in	2JT	K2	2.810 in	2.170 in	1.670 in	0.90 lb	1
6279D	095456062795	Boxed	33	0.08 in	0.500 in	33JT	K32	3.210 in	2.520 in	1.792 in	1.16 lb	1
6281D	095456062818	Boxed	33KD	0.08 in	0.500 in	33JT	K32	3.460 in	2.770 in	1.792 in	1.20 lb	1
6291	095456062917	Boxed	3326A	0.08 in	0.500 in	0.6250 STRAIGHT MOUNT	K32	3.540 in	2.850 in	1.792 in	1.28 lb	1

Jacobs® Thread Mounted - Heavy Duty Model

- Jaws Center-Ground for Absolute Straightness and Alignment
- One-Piece Sleeve Eliminates Crack Between Driving Teeth Often Found in Other Designs
- Through-Hardened Sleeve Teeth, Plus Hardened Nose and Keyholes Provide Outstanding Wear Resistance
- Each Chuck 100% Inspected for Performance and Precision
- T.I.R. .004" Maximum at Half Capacity



Cat. No.	UPC No.	Packaging	Model No.	Min. Capacity	Max. Capacity	Mount	Key No.	Closed Length	Open Length	Sleeve Dia.	Product Weight	Shelf Pack Qty.
33351	095456333512	Boxed	3B 1/2	0.125 in	0.625 in	1/2-20	K3	3.52 in	2.74 in	2.04 in	2.30 lb	1
6232D	095456062320	Boxed	3B 5/8	0.125 in	0.625 in	5/8-16	K3	3.81 in	2.84 in	2.29 in	2.28 lb	1
6255D	095456062559	Boxed	7BA 3/8	0.04 in	0.250 in	3/8-24	K7	2.23 in	1.74 in	1.33 in	0.44 lb	1
8859D	095456088597	Boxed	32BA 1/2	0.04 in	0.375 in	1/2-20	K32	3.05 in	2.31 in	1.79 in	1.10 lb	1
6316D	095456063167	Boxed	36B 3/4	0.188 in	0.800 in	3/4-16	K4	4.12 in	3.20 in	2.54 in	3.06 lb	1
6314D	095456063143	Boxed	36B 5/8	0.188 in	0.800 in	5/8-16	K4	4.12 in	3.20 in	2.54 in	3.10 lb	1

Jacobs® Thread Mounted - Medium Duty Model

- Jaws Center-Ground for Absolute Straightness and Alignment
- One-Piece Sleeve Eliminates Crack Between Driving Teeth Often Found in Other Designs
- Through-Hardened Sleeve Teeth, Plus Hardened Nose and Keyholes Provide Outstanding Wear Resistance
- Each Chuck 100% Inspected for Performance and Precision
- T.I.R. .004" Maximum at Half Capacity
- Models 0 and 1A are Smooth Sleeve.
- All Model 33 Plain Bearing Chucks are Hammer Capable.



Cat. No.	UPC No.	Packaging	Model No.	Min. Capacity	Max. Capacity	Mount	Key No.	Closed Length	Open Length	Sleeve Dia.	Product Weight	Shelf Pack Qty.
6204D	095456062047	Boxed	0B 5/16	0.0135 in	0.156 in	5/16-24	K0	1.53 in	1.17 in	0.85 in	0.13 lb	1
6208D	095456062085	Boxed	1B 3/8	0.040 in	0.250 in	3/8-24	K1	1.95 in	1.57 in	1.12 in	0.32 lb	1
6219D	095456062191	Boxed	2BA 3/8	0.040 in	0.375 in	3/8-24	K2	2.81 in	2.17 in	1.67 in	0.90 lb	1
6287D	095456062870	Boxed	33BA 1/2	0.08 in	0.500 in	1/2-20	K32	3.09 in	2.43 in	1.79 in	1.06 lb	1
6283D	095456062832	Boxed	33BA 3/8	0.08 in	0.500 in	3/8-24	K32	3.09 in	2.43 in	1.79 in	1.10 lb	1
6289D	095456062894	Boxed	33BA 5/8	0.08 in	0.500 in	5/8-16	K32	3.09 in	2.43 in	1.79 in	1.14 lb	1
31090	095456310902	Boxed	41BA 1/2	0.040 in	0.375 in	1/2-20	K30	2.50 in	2.05 in	1.43 in	0.60 lb	1
32282C	095456322820	Boxed	41BA 3/8	0.040 in	0.375 in	3/8-24	K30	2.50 in	2.05 in	1.43 in	0.60 lb	1
31138	095456311381	Boxed	41BA 3/8 - S	0.040 in	0.375 in	3/8-24	K30	2.50 in	2.05 in	1.43 in	0.62 lb	1

Jacobs® Thread Mounted - Light Duty Model

- Industrial Quality
- Through-Hardened Jaws Provide Hard, Durable Gripping Forces

Cat. No.	UPC No.	Packaging	Model No.	Min. Capacity	Max. Capacity	Mount	Key No.	Closed Length	Open Length	Sleeve Dia.	Product Weight	Shelf Pack Qty.
14946	095456149465	Boxed	24BA-3/8	0.063 in	0.50 in	3/8-24	KK	3.00 in	2.30 in	1.72 in	0.96 lb	1
14947	095456149472	Boxed	26BA-1/2	0.063 in	0.50 in	1/2-20	KK	3.00 in	2.30 in	1.72 in	0.94 lb	1

Jacobs® High Precision Model Taper Mounted

- Precision Tested and Certified to 0.0016" T.I.R Max at Half Capacity
- Self-Tightening Feature Automatically Increases Gripping Force Proportional to Increased Torque to Prevent Tool Shank Slippage
- All Components Exposed to Wear are Completely Hardened to Maintain Accuracy and Extend Chuck Life
- Jacobs® Taper Mount Permits Use on a Wide Range of High Accuracy Drill Presses, Jig Borers, Milling Machines and Production Drilling Equipment
- 2Js Mount is a Short Taper



Cat. No.	UPC No.	Packaging	Model No.	Min. Capacity	Max. Capacity	Mount	Closed Length	Open Length	Sleeve Dia.	Product Weight	Shelf Pack Qty.
31121D	095456311213	Boxed	JKP 65-J1	0.012 in	0.255 in	1JT	2.76 in	2.44 in	1.28 in	0.69 lb	1
9679	095456096790	Boxed	JKP 80-J2S	0.012 in	0.315 in	2JS	2.91 in	2.64 in	1.46 in	0.98 lb	1
9681	095456096813	Boxed	JKP 100-J2	0.020 in	0.394 in	2JT	3.50 in	3.19 in	1.61 in	0.57 lb	1
9680	095456096806	Boxed	JKP 100-J33	0.020 in	0.394 in	33JT	3.50 in	3.19 in	1.61 in	0.57 lb	1
9683	095456096837	Boxed	JKP 130-J2	0.039 in	0.512 in	2JT	3.90 in	3.46 in	1.81 in	2.30 lb	1
9684	095456096844	Boxed	JKP 130-J6	0.039 in	0.512 in	6JT	3.90 in	3.46 in	1.81 in	2.20 lb	1
9682D	095456096820	Boxed	JKP 130-J33	0.039 in	0.512 in	33JT	3.90 in	3.46 in	1.81 in	2.22 lb	1
9685D	095456096851	Boxed	JKP 160-J6	0.118 in	0.630 in	6JT	4.21 in	3.74 in	2.17 in	2.82 lb	1

Jacobs® High Torque/High Precision Model

- Precision Tested and Certified to .0016" T.I.R. Maximum at Half Capacity
- For Use on CNC Machining Centers in Drilling, Boring, Counter-Boring and Milling Operations Requiring Heavy Penetration
- Furnished with Spanner Wrench to Allow the Application of Supplementary Gripping Torque. Light Tightening Increases Gripping Torque Up to 3 Times Higher Than Hand Tightening
- Resists Tool Loosening on High-Speed Machines with Right Hand Rotation and Instant Spindle Stop.
- 2Js Mount is a Short Taper



Cat. No.	UPC No.	Packaging	Model No.	Min. Capacity	Max. Capacity	Mount	Closed Length	Open Length	Sleeve Dia.	Product Weight	Shelf Pack Qty.
30533	095456305335	Boxed	JKT 100-J2	0.000 in	0.394 in	2JT	3.50 in	3.19 in	1.61 in	2.03 lb	1
30532D	095456305328	Boxed	JKT 100-J33	0.000 in	0.394 in	33JT	3.50 in	3.19 in	1.61 in	1.76 lb	1
30527	095456305274	Boxed	JKT 130-J2	0.039 in	0.512 in	2JT	3.90 in	3.46 in	1.81 in	0.00 lb	1
30529	095456305298	Boxed	JKT 130-J6	0.039 in	0.512 in	6JT	3.90 in	3.46 in	1.81 in	0.00 lb	1
30528	095456305281	Boxed	JKT 130-J33	0.039 in	0.512 in	33JT	3.90 in	3.46 in	1.81 in	0.00 lb	1
31122D	095456311220	Boxed	JKT65-J1	0.000 in	0.255 in	1JT	2.76 in	2.44 in	1.28 in	1.20 lb	1
30526D	095456305267	Boxed	JKT80-J2S	0.000 in	0.315 in	2JS	2.91 in	2.64 in	1.46 in	1.50 lb	1
30530D	095456305304	Boxed	JKT160-J6	0.118 in	0.630 in	6JT	4.21 in	3.74 in	2.17 in	0.00 lb	1

Jacobs® High Torque/High Precision Chucks with Integrated Shank

- High Precision Keyless Drill Chuck - Arbor is Integrated Into the Internal Socket of the Drill Chuck
- This Integrated Design Makes It Impossible for the Arbor and the Drill Chuck to Become Accidentally Separated, Providing a Unit of Greater Rigidity and Precision As a Result of Its Compact Design, Accumulated Run-Out is Reduced to a Minimum
- Self-Tightening Feature Automatically Increases Gripping Force Proportional to Increased Torque to Prevent Tool Shank Slippage. Right Handed Operation Only
- 100% Individually Controlled to Ensure Not to Exceed a Maximum Total Integrated Run-Out of 0.0016 in
- Mounts Available: Morse Tapers, Straight Shanks and R-8



Cat. No.	UPC No.	Packaging	Model No.	Min. Capacity	Max. Capacity	Mount	Closed Length	Open Length	Sleeve Dia.	Product Weight	Shelf Pack Qty.
31406D	095456314061	Boxed	JK 80-MT2	0.000 in	0.315 in	MT2	2.83 in	2.56 in	1.50 in	1.35 lb	1
31407D	095456314078	Boxed	JK 100-MT2	0.000 in	0.394 in	MT2	3.23 in	2.87 in	1.69 in	1.81 lb	1
31408D	095456314085	Boxed	JK 130-MT2	0.039 in	0.512 in	MT2	3.62 in	3.15 in	1.89 in	2.65 lb	1
31409	095456314092	Boxed	JK 130-MT3	0.039 in	0.512 in	MT3	3.62 in	3.15 in	1.89 in	2.47 lb	1
31410	095456314108	Boxed	JK 130-MT4	0.039 in	0.512 in	MT4	3.54 in	3.23 in	1.89 in	3.72 lb	1
31411	095456314115	Boxed	JK 130-R8	0.039 in	0.512 in	R8	3.54 in	3.23 in	1.89 in	3.20 lb	1
31414	095456314146	Boxed	JK 160-MT3	0.118 in	0.630 in	MT3	3.78 in	3.35 in	2.13 in	3.21 lb	1
31415	095456314153	Boxed	JK 160-MT4	0.118 in	0.630 in	MT4	3.78 in	3.35 in	2.13 in	4.29 lb	1
31416	095456314160	Boxed	JK 160-R8	0.118 in	0.630 in	R8	3.78 in	3.35 in	2.13 in	3.79 lb	1

Jacobs® Medium Duty Industrial Chucks

- Drill Chucks for Industrial Use (Medium Duty), Available with Threaded Mounts for Professional Portable Drilling Machines and with Taper Fittings for Stationary Drilling Machines
- Automatic Fitting for Efficient, Fast Change of Tools
- Self-Tightening Mechanism Automatically Increases the Grip in Proportion to the Increase in Torque During Drilling
- Fits Tools of Up to 20mm in Diameter.
- Machine Fitting Via DIN0238 of Jacobs Tapers and UNF Thread Fittings



Cat. No.	UPC No.	Packaging	Model No.	Min. Capacity	Max. Capacity	Mount	Closed Length	Open Length	Sleeve Dia.	Product Weight	Shelf Pack Qty.
33363D	095456333635	Boxed	JK 130 1/2	0.039 in	0.512 in	1/2-20	3.74 in	3.39 in	1.73 in	1.58 lb	1
33362	095456333628	Boxed	JK 130 3/8	0.039 in	0.512 in	3/8-24	3.74 in	3.39 in	1.73 in	1.60 lb	1
33365	095456333659	Boxed	JK 130 J2	0.039 in	0.512 in	2JT	3.74 in	3.39 in	1.73 in	1.16 lb	1
33366	095456333666	Boxed	JK 130 J6	0.039 in	0.512 in	6JT	3.74 in	3.39 in	1.73 in	1.00 lb	1
33364	095456333642	Boxed	JK 130 J33	0.039 in	0.512 in	33JT	3.74 in	3.39 in	1.73 in	1.16 lb	1

Jacobs[®] Die Grinder Chucks

- Compact Tap Chuck Designed for Use with Rubber-Flex[®] Collets Holds Mounted Grinding Burrs and Rotary Files on Pneumatic and Electric Die Grinders
- Compact Design Facilitates Use for a Wide Range of Applications
- Integral Seal Protects Collet Components From Abrasives and Swarf
- Rubber-Flex[®] Collets (See Rubber-Flex[®] Information) Furnished Separately for Tools with Collet Seating Cones Built Into Spindles.



Cat. No.	UPC No.	Packaging	Model No.	Product Weight	Shelf Pack Qty.
9756	095456097568	Boxed	100-61	0.09 lb	1

Jacobs[®] Nut for Die Grinder Chuck

Cat. No.	UPC No.	Packaging	Description	Model No.	Product Weight	Shelf Pack Qty.
12791	095456127913	Boxed	Nut for Die Grinder Chuck, Model No. 100-61	N100	0.02 lb	1

Jacobs[®] Tap Chuck Collets

- Parallel Jaw Insert Surfaces Exert Uniform, Accurate Gripping Force Up to Three Times Greater Than Can Be Achieved with Split-Steel Collets
- Each Collet Accepts and Precisely Centers a Wide Range of Both Decimal or Metric Diameters (Within Individual Capacity Ranges) to Speed Setups and Increase Machining Productivity
- Durable One-Piece Construction. Synthetic Rubber Retains Flexibility and Resists Deterioration From Heat, Coolants and Cutting Compounds
- Steel Jaw Inserts Precision Ground After Molding Process to Ensure Maximum Gripping Accuracy. Hardened for Greater Wear Resistance Than Split Steel Collets
- Each Collet Bore is Held Concentric to the O.D. Tapers, Front and Back, to Minimize T.I.R.
- Automatically Seals Tool O.D. to Prevent Coolant Flow Through Thus Increasing Tool Wear
- Seals Collets and Machine Spindles to Protect From Abrasive Particles and Swarf



Cat. No.	UPC No.	Packaging	Model No.	Min. Capacity	Max. Capacity	Contact Length	Cone Angle	Outside Diameter	No. of Inserts	Product Weight	Shelf Pack Qty.
9747	095456097476	Boxed	J420	0.176 in	0.320 in	0.500 in	40 °	0.941 in	6	0.02 lb	1
9748	095456097483	Boxed	J421	0.139 in	0.257 in	0.500 in	40 °	0.941 in	6	0.00 lb	1
9751	095456097513	Boxed	J422	0.253 in	0.383 in	0.500 in	40 °	0.941 in	6	0.70 lb	1
9817	095456098176	Boxed	J423	0.090 in	0.180 in	0.500 in	40 °	0.860 in	4	0.02 lb	1
9749	095456097490	Boxed	J440	0.280 in	0.500 in	0.630 in	45 °	1.296 in	6	1.00 lb	1
9750D	095456097506	Boxed	J441	0.176 in	0.383 in	0.630 in	45 °	1.296 in	6	0.04 lb	1
9867	095456098671	Boxed	J443	0.110 in	0.280 in	0.620 in	45 °	1.180 in	4	0.04 lb	1

Jacobs® Die Grinder Collets



Cat. No.	UPC No.	Packaging	Model No.	Min. Capacity	Max. Capacity	Contact Length	Cone Angle	Outside Diameter	No. of Inserts	Product Weight	Shelf Pack Qty.
9757	095456097575	Boxed	J116	0.094 in	0.177 in	0.468 in	26 °	0.59 in	6	0.02 lb	1
9758	095456097582	Boxed	J117	0.177 in	0.256 in	0.468 in	26 °	0.59 in	8	0.01 lb	1

Jacobs® Lathe Chuck Collets

- Parallel Jaw Insert Surfaces Exert Uniform, Accurate Gripping Force Up to Three Times Greater Than Can Be Achieved with Split-Steel Collets
- Each Collet Accepts and Precisely Centers a Wide Range of Both Decimal or Metric Diameters (Within the Collet Capacity Range) to Speed Setups and Increase Machining Productivity
- Durable One-Piece Construction. Synthetic Rubber Retains Flexibility and Resists Deterioration From Heat, Coolants and Cutting Compounds
- Steel Jaw Inserts Precision Ground After Molding Process to Ensure Maximum Gripping Accuracy. Hardened for Greater Wear Resistance Than Split Steel Collets
- Each Collet Bore is Held Concentric to the O.D. Tapers, Front and Back, to Minimize T.I.R.
- Automatically Seals Tool O.D. to Prevent Coolant Flow Through Thus Increasing Tool Wear
- Seals Collets and Machine Spindles to Protect From Abrasive Particles and Swarf



Cat. No.	UPC No.	Packaging	Model No.	Min. Capacity	Max. Capacity	Contact Length	Cone Angle	Outside Diameter	Clearance Diameter	No. of Inserts	Product Weight	Shelf Pack Qty.
9555D	095456095557	Bagged	J910	0.060 in	0.125 in	1.74 in	26 °	2.25 in	0.6	4	0.44 lb	1
9556D	095456095564	Bagged	J911	0.125 in	0.250 in	1.74 in	26 °	2.25 in	0.6	6	0.54 lb	1
9557DD	095456095571	Bagged	J912	0.250 in	0.375 in	1.74 in	26 °	2.25 in	0.6	6	0.52 lb	1
9558D	095456095588	Bagged	J913	0.375 in	0.500 in	1.74 in	26 °	2.25 in	-	8	0.44 lb	1
9559D	095456095595	Bagged	J914	0.500 in	0.625 in	1.74 in	26 °	2.25 in	-	10	0.48 lb	1
9560D	095456095601	Bagged	J915	0.625 in	0.750 in	1.74 in	26 °	2.25 in	-	10	0.48 lb	1
9561	095456095618	Bagged	J916	0.750 in	0.875 in	1.74 in	26 °	2.25 in	-	12	0.48 lb	1
9562	095456095625	Bagged	J917	0.875 in	1.000 in	1.74 in	26 °	2.25 in	-	16	0.56 lb	1
9563	095456095632	Bagged	J918	1.000 in	1.125 in	1.74 in	26 °	2.25 in	-	20	0.52 lb	1
9564	095456095649	Bagged	J919	1.125 in	1.250 in	1.74 in	26 °	2.25 in	-	24	0.44 lb	1
9565D	095456095656	Bagged	J920	1.250 in	1.375 in	1.74 in	26 °	2.25 in	-	24	0.42 lb	1
9567	095456095670	Bagged	J921	1.375 in	1.500 in	1.74 in	26 °	2.25 in	-	24	0.36 lb	1

Jacobs® Morse Taper Jacobs® Taper Arbor

- Adapt Jacobs® Taper To: Morse Tapers, Straight Shanks, Threaded Shanks and Bridgeport® Tapers
- Ideal for Use with Custom Tool and Work Holder Designs and for Specialized Machining Applications



Cat. No.	UPC No.	Packaging	A0 No.	Mount	Overall Length	Product Weight	Shelf Pack Qty.
7299	095456072992	Boxed	A0101	1 Morse X 1JT	3.38 in	0.12 lb	1
7300	095456073005	Boxed	A0102	1 Morse x 2 JT	3.59 in	0.16 lb	1
7303	095456073036	Boxed	A0106	1 Morse x 6JT	3.72 in	0.22 lb	1
7304	095456073043	Boxed	A0133	1 Morse x 33JT	3.72 in	0.20 lb	1
7306	095456073067	Boxed	A0201	2 Morse x 1JT	3.94 in	0.30 lb	1
7307	095456073074	Boxed	A0202	2 Morse x 2JT	4.16 in	0.34 lb	1
7308D	095456073081	Boxed	A0203	2 Morse x 3JT	4.50 in	0.46 lb	1
7309	095456073098	Boxed	A0204	2 Morse x 4JT	4.94 in	0.76 lb	1
7311	095456073111	Boxed	A0206	2 Morse x 6JT	4.28 in	0.38 lb	1
7312	095456073128	Boxed	A0233	2 Morse x 33JT	4.28 in	0.36 lb	1
7313D	095456073135	Boxed	A0301	3 Morse x 1JT	4.69 in	0.60 lb	1
7314	095456073142	Boxed	A0302	3 Morse x 2JT	4.94 in	0.66 lb	1
7315	095456073159	Boxed	A0303	3 Morse x 3JT	5.27 in	0.78 lb	1
7316D	095456073166	Boxed	A0304	3 Morse x 4JT	5.70 in	1.08 lb	1
7317	095456073173	Boxed	A0305	3 Morse x 5JT	5.94 in	1.44 lb	1
7318	095456073180	Boxed	A0306	3 Morse x 6JT	5.06 in	0.70 lb	1
7319D	095456073197	Boxed	A0333	3 Morse x 33JT	5.06 in	0.68 lb	1
7320	095456073203	Boxed	A0402	4 Morse x 2JT	5.91 in	1.36 lb	1
7321	095456073210	Boxed	A0403	4 Morse x 3JT	6.25 in	1.48 lb	1
7322D	095456073227	Boxed	A0404	4 Morse x 4JT	6.69 in	1.82 lb	1
7323D	095456073234	Boxed	A0405	4 Morse x 5JT	6.91 in	2.16 lb	1
7324D	095456073241	Boxed	A0406	4 Morse x 6JT	6.03 in	1.37 lb	
7325	037103475763	Boxed	A0433	4 Morse x 33JT	6.06 in	1.37 lb	3
7327	095456073272	Boxed	A0503	5 Morse x 3JT	7.50 in	3.31 lb	1
7328D	095456073289	Boxed	A0504	5 Morse x 4JT	7.94 in	3.80 lb	1
7329	095456073296	Boxed	A0505	5 Morse x 5JT	8.16 in	4.06 lb	1

Jacobs® Straight Shank To Jacobs® Taper

- Precision Machined and Ground to Master Gages for Maximum Performance with Jacobs® Drill and Tap Chucks
- Ideal for Use with Custom Tool and Work Holder Designs and for Specialized Machining Applications



Cat. No.	UPC No.	Packaging	AO No.	Mount	Overall Length	Straight Shank Length (L-1)	Product Weight	Shelf Pack Qty.
7348D	095456073487	Boxed	A4000	1/2" x 0JT	3.094 in	2.500	0.13 lb	1
7349	095456073494	Boxed	A4001	1/2" x 1JT	3.312 in	2.500	0.13 lb	1
7350	095456073500	Boxed	A4002	1/2" x 2JT	3.531 in	2.500	0.20 lb	1
7351	095456073517	Boxed	A4003	1/2" x 3JT	3.875 in	2.500	0.25 lb	1
7353	095456073531	Boxed	A4006	1/2" x 6JT	3.656 in	2.500	0.25 lb	1
7354D	095456073548	Boxed	A4033	1/2" x 33JT	3.656 in	2.500	0.25 lb	1
7355	095456073555	Boxed	A4101	5/8" x 1JT	3.312 in	2.500	0.26 lb	1
7356	095456073562	Boxed	A4102	5/8" x 2JT	3.531 in	2.500	0.31 lb	1
7357	095456073579	Boxed	A4103	5/8" x 3JT	3.875 in	2.500	0.37 lb	1
7359	095456073593	Boxed	A4106	5/8" x 6JT	3.656 in	2.500	0.37 lb	1
7360D	095456073609	Boxed	A4133	5/8" x 33JT	3.656 in	2.500	0.37 lb	1
7361	095456073616	Boxed	A4202	3/4" x 2JT	4.031 in	3.000	0.37 lb	1
7362	095456073623	Boxed	A4203	3/4" x 3JT	4.375 in	3.000	0.37 lb	1
7364D	095456073647	Boxed	A4206	3/4" x 6JT	4.156 in	3.000	0.37 lb	1
7365	095456073654	Boxed	A4233	3/4" x 33JT	4.156 in	3.000	0.37 lb	1
7367	095456073678	Boxed	A4303	1" x 3JT	4.375 in	3.000	0.68 lb	1
7368	095456073685	Boxed	A4306	1" x 6JT	4.156 in	3.000	0.68 lb	1

Jacobs® Threaded Shank To Morse Taper

- Precision Machined and Ground to Master Gages for Maximum Performance with Jacobs® Drill and Tap Chucks
- Ideal for Use with Custom Tool and Work Holder Designs and for Specialized Machining Applications



Cat. No.	UPC No.	Packaging	AO No.	Mount	Overall Length	Threaded Extension (L-1)	Product Weight	Shelf Pack Qty.
7345D	095456073456	Boxed	A0261	2 Morse 3/8" - 24	3.69 in	0.56	0.28 lb	1
7346D	095456073463	Boxed	A0264	2 Morse 1/2" - 20	4.06 in	0.56	0.34 lb	1
7347D	095456073470	Boxed	A0268	2 Morse 5/8" - 16	4.19 in	0.69	0.42 lb	1

Jacobs® Bridgeport® Taper to Jacobs® Taper

- Precision Machined and Ground to Master Gages for Maximum Performance with Jacobs® Drill and Tap Chucks



Cat. No.	UPC No.	Packaging	AO No.	Mount	Overall Length Min	Overall Length Max	Mount Length (C) Min	Mount Length (C) Max	Diameter (D) Min	Diameter (D) Max	Product Weight	Shelf Pack Qty.
7339	095456073395	Boxed	A0802	2JT	5.18 in	5.20 in	0.91 in	0.92 in	0.49 in	0.56 in	1.00 lb	1
7340D	095456073401	Boxed	A0803	3JT	5.53 in	5.55 in	1.25 in	1.27 in	0.75 in	0.81 in	1.10 lb	1
7341	095456073418	Boxed	A0804	4JT	5.97 in	5.98 in	1.69 in	1.70 in	1.04 in	1.12 in	1.36 lb	1
7342D	095456073425	Boxed	A0806	6JT	5.31 in	5.33 in	1.03 in	1.05 in	0.62 in	0.68 in	1.02 lb	1
7343	095456073432	Boxed	A0833	33JT	5.31 in	5.33 in	1.03 in	1.05 in	0.56 in	0.62 in	0.98 lb	1

Jacobs® Drill Sleeves - Morse Taper - Archer® Series 600

- Adapt Smaller Morse Taper Shank Tools to Larger Machine Spindles
- Oil Toughened and Externally Precision Ground with Hardened Tang
- Outside Morse Taper Sizes are 1 Through 6; Inside Morse Taper Sizes are 0 Through 5



Cat. No.	UPC No.	Packaging	Model No.	Morse Taper No. Outside	Morse Taper No. Inside	Overall Length	Product Weight	Shelf Pack Qty.
30421D	095456304215	Boxed	610	1	0	3.125 in	0.10 lb	1
30422D	095456304222	Boxed	621	2	1	3.62 in	0.20 lb	1
30424	095456304246	Boxed	631	3	1	3.88 in	0.37 lb	1
30423D	095456304239	Boxed	632	3	2	4.38 in	0.42 lb	1
30427D	095456304277	Boxed	641	4	1	4.88 in	1.06 lb	1
30426D	095456304260	Boxed	642	4	2	4.88 in	0.87 lb	1
30425D	095456304253	Boxed	643	4	3	5.50 in	0.90 lb	1
30638	095456306387	Boxed	651	5	1	6.12 in	3.28 lb	1
30430D	095456304307	Boxed	652	5	2	6.12 in	2.87 lb	1
30429D	095456304291	Boxed	653	5	3	6.12 in	2.56 lb	1
30428D	095456304284	Boxed	654	5	4	6.69 in	2.24 lb	1
30639	095456306394	Boxed	664	6	4	8.56 in	5.50 lb	1
30431D	095456304314	Boxed	665	6	5	8.56 in	5.62 lb	1

Jacobs® Extension Sockets - Morse Taper - Archer® Series 800

- Extend Tool Lengths and Application Distances While Adapting for Increases or Decreases in Applied Tool Morse Taper Sizes
- Externally Precision Ground with Hardened Tang
- Outside and Inside Morse Taper Sizes are 1 Through 5



Cat. No.	UPC No.	Packaging	Model No.	Morse Taper No. Outside	Morse Taper No. Inside	Overall Length	Outside Diameter	Socket Length (A)	Product Weight	Shelf Pack Qty.
30443D	095456304437	Boxed	811	1	1	5.71 in	0.79 in	2.99 in	0.40 lb	1
30444	095456304444	Boxed	812	1	2	6.30 in	1.18 in	3.58 in	0.92 lb	1
30445	095456304451	Boxed	821	2	1	6.30 in	0.80 in	2.99 in	0.56 lb	1
30446	095456304468	Boxed	822	2	2	6.89 in	1.18 in	3.58 in	1.22 lb	1
30447D	095456304475	Boxed	823	2	3	7.72 in	1.42 in	4.41 in	1.58 lb	1
30448D	095456304482	Boxed	831	3	1	6.89 in	0.79 in	2.99 in	0.87 lb	1
30449D	095456304499	Boxed	832	3	2	7.64 in	1.18 in	3.58 in	0.60 lb	1
30450D	095456304505	Boxed	833	3	3	8.46 in	1.42 in	4.41 in	2.04 lb	1
30451D	095456304512	Boxed	834	3	4	9.45 in	1.89 in	5.39 in	3.43 lb	1
30640D	095456306400	Boxed	842	4	2	8.46 in	1.18 in	3.58 in	1.07 lb	1
30452	095456304529	Boxed	843	4	3	9.45 in	1.42 in	4.41 in	1.09 lb	1
30453D	095456304536	Boxed	844	4	4	10.43 in	1.89 in	5.39 in	4.20 lb	1
30454	095456304543	Boxed	845	4	5	11.81 in	2.48 in	6.77 in	7.14 lb	1
30641	095456306417	Boxed	853	5	3	10.35 in	1.42 in	4.41 in	2.60 lb	1
30455D	095456304550	Boxed	854	5	4	11.81 in	1.89 in	5.39 in	2.65 lb	1
30456	095456304567	Boxed	855	5	5	13.19 in	2.48 in	6.77 in	9.44 lb	1

Jacobs® Ejecting Drifts

- Hardened and Tempered
- Eject Morse Taper Sizes 0 Through 6 From Sleeves, Sockets and Machine Spindles

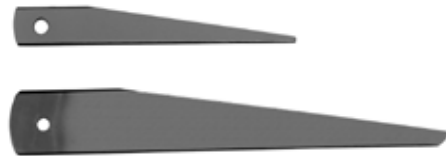

Cat. No.	UPC No.	Packaging	Model No.	Application	Product Weight	Shelf Pack Qty.
30484	095456304840	Boxed	900	For ejection of No. 0 Morse Taper	0.08 lb	1
30485	095456304857	Boxed	902	For ejection of Nos. 1 & 2 Morse Tapers	0.18 lb	1
30486	095456304864	Boxed	903	For ejection of Nos. 3 & 4 Morse Tapers	0.37 lb	1
30487D	095456304871	Boxed	904	For ejection of Nos. 4 & 5 Morse Tapers	0.75 lb	1
30488D	095456304888	Boxed	906	For ejection of No. 6 Morse Taper	1.45 lb	1
30489D	095456304895	Boxed	914	For ejection of Nos. 4 & 5	0.63 lb	1

Jacobs® Hand-Tite® Keyless Drill Chucks

- Split Bite Jaw: Increases Grip Over Standard Bite Chucks By Providing More Contact with the Bit
- Superior Gripping Force: Provides High Mechanical Advantage to Convert Hand Tightening Torque Into Superior Bit Gripping Force
- Hammerlock® Mechanism: Positive Locking Mechanism Prevents Loosening in Hammer and Other High Vibration Applications
- Anti-Lock Nut: Prevents Chuck From Locking Open
- Versatility: Models Available to Fit All 10mm (3/8") and 13mm (1/2") Variable Speed Corded and Cordless Portable Drills
- Precision Operation: Meet or Exceed Stringent DIN Run-Out and Dimensional Specifications
- Ergonomic Design: Material and Surface Finish Combinations Result in Increased Comfort and Performance
- Rugged Construction: Constructed of High Performance Material to Maximize Durability and Performance



Cat. No.	UPC No.	Packaging	Model No.	Min. Capacity	Max. Capacity	Mount	Closed Length	Sleeve Dia.	Product Weight	Shelf Pack Qty.
30354	095456303546	Boxed	510-2H	0.040 in	0.375 in	3/8-24	2.00 in	1.68 in	0.50 lb	1
31037D	095456310377	Boxed	513-2M	0.062 in	0.500 in	3/8-24	2.9 in	1.68 in	0.63 lb	1
31038D	095456310384	Boxed	513-2M	0.062 in	0.500 in	1/2-20	2.9 in	1.68 in	0.70 lb	1

Jacobs® Professional Duty Chucks

- Industrial Quality
- Through-Hardened Jaws Provide Hard, Durable Gripping Surfaces
- One-Piece Sleeve Eliminates Crack Between Driving Teeth Often Found in Other Designs
- Fluted Sleeve Finish
- Each Chuck 100% Inspected for Performance and Precision



Cat. No.	UPC No.	Packaging	Model No.	Min. Capacity	Max. Capacity	Mount	Key No.	Closed Length	Open Length	Sleeve Dia.	Product Weight	Shelf Pack Qty.
31052D	095456310520	Boxed	26BA-1/2	0.063 in	0.5 in	1/2-20	KK	3 in	2.3 in	1.72 in	1.38 lb	1
30246D	095456302464	Boxed	41BA-3/8	0.063 in	0.375 in	3/8-24	K30	2.42 in	1.89 in	1.42 in	0.31 lb	1

Jacobs® Multi-Craft® Drill Chuck

- Offered in 1/4", 3/8" and 1/2" Capacities
- Through-Hardened Jaws for Hard, Wear Resistant Gripping Surfaces



Cat. No.	UPC No.	Packaging	Min. Capacity	Max. Capacity	Mount	Key No.	Closed Length	Open Length	Sleeve Dia.	Product Weight	Shelf Pack Qty.
30243D	095456302433	Boxed	0.028 in	0.25 in	3/8-24	KG1	2.02 in	1.575 in	1.13 in	0.30 lb	1
30247D	095456302471	Boxed	0.062 in	0.375 in	3/8-24	KG1	2.312 in	1.85 in	1.22 in	0.70 lb	1
30598	095456305984	Boxed	0.078 in	0.5 in	3/8-24	KK	2.855 in	2.25 in	1.61 in	0.65 lb	1
30602	095456306028	Boxed	0.078 in	0.5 in	1/2-20	KK	2.855 in	2.25 in	1.61 in	0.16 lb	1

Jacobs® Replacement Parts

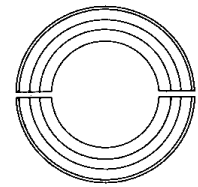
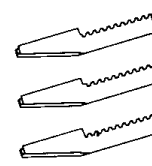
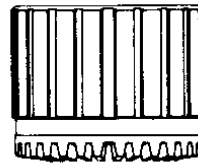

Cat. No.	UPC No.	Packaging	Description	Chuck Series No.	Product Weight	Shelf Pack Qty.
4944	095456049444	Boxed	Replacement Sleeve for 3 Series Chuck	3	0.54 lb	1
5016D	095456050167	Boxed	Replacement Sleeve for 33 Series Chuck	33	0.25 lb	1
5046	095456050464	Boxed	Replacement Sleeve for 34 Series Chuck	34	0.42 lb	1
	095456050662	Boxed	Replacement Sleeve for 36 Series Chuck	36	0.65 lb	1
7417D	095456074170	Boxed	Replacement Jaw and Nut Unit for 3 Series Chuck	3	0.53 lb	1
7423	095456074231	Boxed	Replacement Jaw and Nut Unit for 33 Series Chuck	33	0.55 lb	1
7424D	095456074248	Boxed	Replacement Jaw and Nut Unit for 34 Series Chuck	34	0.53 lb	1
7425	095456074255	Boxed	Replacement Jaw and Nut Unit for 36 Series Chuck	36	0.58 lb	1

Jacobs® Adapt-A-Drive® Chuck

- Easy Conversion-Integral Hex Mount Locks the Adapt-A-Drive Chuck Into the Screwdriver Bit Socket
- Ideal for Use in Starting Screw Holes for Use in Hard-To-Reach Spaces



Cat. No.	UPC No.	Packaging	Min. Capacity	Max. Capacity	Mount	Key No.	Sleeve Dia.	Product Weight	Shelf Pack Qty.
30248D	095456302488	Boxed	0.028 in	0.25 in	0.250" Hex	KG1	1.13 in	0.45 lb	1

Jacobs® Stainless Steel Chucks

- For Special Applications on Either Portable Air Operated or Stationary Machine Tools
- Resist Chemical Corrosion and Reduce Potential for Hazardous Sparking

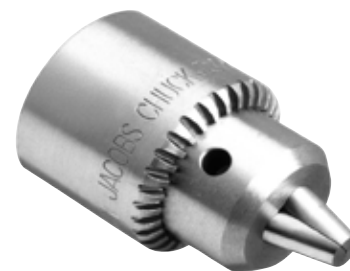

Cat. No.	UPC No.	Packaging	Model No.	Min. Capacity	Max. Capacity	Mount	Key No.	Closed Length	Open Length	Sleeve Dia.	Product Weight	Shelf Pack Qty.
6625	095456066250	Boxed	0BM	0.028 in	0.156 in	5/16-24	K0M	1.53 in	1.17 in	0.85 in	0.20 lb	1
6624	095456066243	Boxed	0M	0.028 in	0.156 in	0JT	K0M	1.45 in	1.1 in	0.85 in	0.20 lb	1
6627D	095456066274	Boxed	1BM	0.028 in	0.25 in	5/16-24	K1M	1.95 in	1.57 in	1.12 in	0.32 lb	1
6628	095456066281	Boxed	1BM	0.028 in	0.25 in	3/8-24	K1M	1.95 in	1.57 in	1.12 in	0.32 lb	1
6626	095456066267	Boxed	1M	0.028 in	0.25 in	1JT	K1M	1.92 in	1.54 in	1.12 in	0.32 lb	1

Jacobs® Drain Chuck

- Specifically Designed for Use with Flexible Coil Spring Tools. Allows Coil Spring to Pass Through Chuck
- Idea for Soil Pipe and Sewer Cleaning Tools



Cat. No.	UPC No.	Packaging	Model No.	Min. Capacity	Max. Capacity	Mount	Key No.	Open Length	Sleeve Dia.	Closed Length	Product Weight	Shelf Pack Qty.
30726	095456307261	Boxed	DC4595	0.25 in	0.5 in	13/16-20	--	2.49 in	1.7 in	2.49 in	0.28 lb	1

Jacobs® Chuck Keys

- Nickel Thumb Grip Styles Increase Leverage and User Comfort
- Soft Steel Handles Limit the Potential for Dangerous Fracturing Under Excessive Load
- Self-Ejecting Models with Spring-Loaded Ejectors Ensure Key Disengagement After Tightening
- Never Apply Extensions, Pliers, Wrenches or 'Cheaters' of Any Kind to Chuck Key Handles
- Do Not Subject Chuck Key Handles to Hammer or Other Impact Blows



Cat. No.	UPC No.	Packaging	Model No.	Pilot Size	Used On	Handle Style	No. Teeth	Product Weight	Shelf Pack Qty.
30827D	095456308275	Bagged	-	13/64 in	1/4 & 3/8" chucks	T-handle	11	0.07 lb	1
3637	095456036376	Bagged	K0	1/8 in	0 Series	T-handle	11	0.04 lb	1
3639	095456036390	Bagged	K0M	1/8 in	0 Series Stainless	T-handle	11	0.05 lb	1
3641	095456036413	Bagged	K1	5/32 in	1 Series	T-handle	11	0.04 lb	1
3643	095456036437	Bagged	K1M	5/32 in	1 Series Stainless	T-handle	11	0.60 lb	1
3649D	095456036499	Bagged	K2	1/4 in	2 Series	Thumb Handle	11	0.13 lb	1
3651D	095456036512	Bagged	K3	5/16 in	3, 34 Series & 14N	Thumb Handle	11	0.55 lb	1
3653	095456036536	Bagged	K3C	5/16 in	34-33 C	Thumb Handle	11	0.00 lb	1
3655DD	095456036550	Bagged	K4	3/8 in	36, 16, 18N	Thumb Handle	12	0.34 lb	1
3657	095456036574	Bagged	K5	7/16 in	20N	T-handle	12	0.68 lb	1
3659D	095456036598	Bagged	K7	7/32 in	7 Series	Thumb Handle	11	0.06 lb	1
3664	095456036642	Bagged	K30	15/64 in	31 Series & 8-1/2N	Thumb Handle	10	0.15 lb	1
3666	095456036666	Bagged	K32	1/4 in	32,33 Series& 11N	Thumb Handle	10	0.55 lb	1
14273D	095456142732	Bagged	KG1	1/4 in	1/4 & 3/8" Multi-Craft® (black handle)	T-handle	11	0.04 lb	1
3605	095456036055	Bagged	KGA	1/4 in	1/4 & 3/8" Multi-Craft®	L-handle	11	0.00 lb	1
30052D	095456300521	Bagged	KK	9/32 in	DC8, SM8, 74K, 22BA, 23BA, 24BA, 26BA, 29-33,	T-handle	10	0.10 lb	1

Jacobs® Self-Ejecting Keys

- Nickel Thumb Grip Styles Increase Leverage and User Comfort
- Soft Steel Handles Limit the Potential for Dangerous Fracturing Under Excessive Load
- Self-Ejecting Models with Spring-Loaded Ejectors Ensure Key Disengagement After Tightening
- Never Apply Extensions, Pliers, Wrenches or 'Cheaters' of Any Kind to Chuck Key Handles
- Do Not Subject Chuck Key Handles to Hammer or Other Impact Blows



Cat. No.	UPC No.	Packaging	Model No.	Pilot Size	Used On	No. Teeth	Product Weight	Shelf Pack Qty.
2948D	095456029484	Bagged	S-K3C	5/16 in	3, 34 Series & 14N	11	0.20 lb	1
3157D	095456031579	Bagged	S-KK	9/32 in	DC8, SM8, 74K, 22BA, 23BA, 24BA, 26BA	10	0.00 lb	1

Jacobs® Wedge Sets

- For Removing Taper Mount Chucks



Cat. No.	UPC No.	Packaging	Model No.	Used On	Product Weight	Shelf Pack Qty.
13266	095456132665	Bagged	#1 WEDGE SET	1JT	0.05 lb	1
13267	095456132672	Bagged	#2 WEDGE SET	2JT	0.10 lb	1
13268	095456132689	Bagged	#3 WEDGE SET	3JT	0.12 lb	1
13269	095456132696	Bagged	#6 WEDGE SET	6JT	0.10 lb	1

Jacobs® Key Leashes



Cat. No.	UPC No.	Packaging	Model No.	Used On	Product Weight	Shelf Pack Qty.
3685D	095456036857	Bagged	Model A	K0, K1, K7, KG	0.02 lb	1
3686D	095456036864	Bagged	Model B	K30, K32, K2, KK	0.02 lb	1

TECHNICAL INFORMATION

Jacobs® Tapers

The tables below reproduce and classify the normal dimensions of Jacobs® tapers and mounts. They also observe the generally accepted designation. In effect, the range of increasing values for diameter D contains two No. 2 tapers, the first of which is No. 2 short taper. Between the tapers 2 and 3, there are two interpolated tapers which bear the out-of-series numbers 33 and 6 respectively.

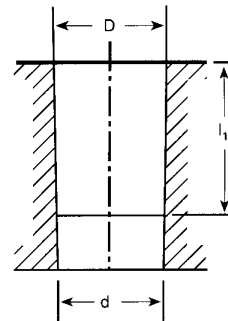

Jacobs Taper No.	D		d		l ₁		Taper on Diameter	
	IN	MM	IN	MM	IN	MM	IN	MM
0	0.2500	6.350	0.2284	5.802	0.43750	11.112	0.59145	15.023
1	0.3840	9.754	0.3334	8.469	0.56525	16.669	0.92508	23.497
2 short	0.5488	13.940	0.4876	12.386	0.75000	19.050	0.97861	24.857
2	0.5590	14.199	0.4876	12.386	0.87500	22.225	0.97861	24.857
33	0.6240	15.850	0.5605	14.237	1.00000	25.400	0.76194	19.353
6	0.6760	17.170	0.6241	15.852	1.00000	25.400	0.62292	15.822
3	0.8110	20.599	0.7461	18.951	1.21758	30.956	0.63898	16.230
4	1.1240	28.550	1.0372	26.346	1.65625	42.069	0.62886	15.973
5	1.4130	35.890	1.3161	33.422	1.87500	47.625	0.62010	15.773

Jacobs® Standard Threaded Mounts

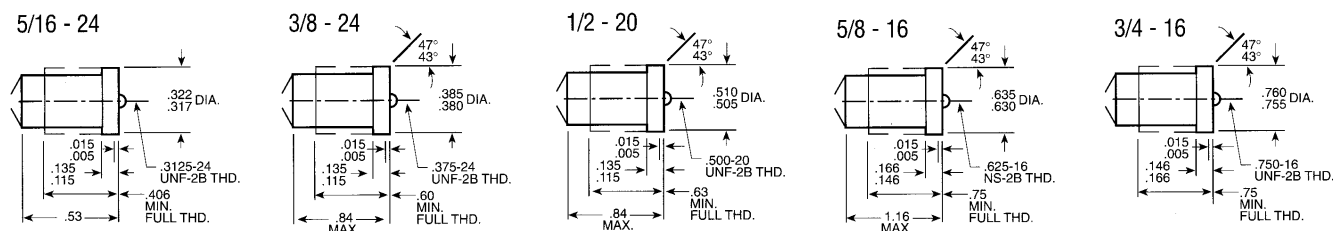

Jacobs® Standard Straight Mount

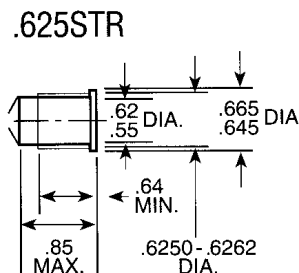

NOTE: All dimensions are in inches unless otherwise specified.

CAUTION: When designing for new applications, contact the Engineering Department, The Jacobs® Chuck Manufacturing Company for current specifications.

Din Tapers

DIN TAPER INTERHANGABILITY

DIN tapered sections are identical with the following Morse tapers:

No. 1, for tapers B10 and B12

No. 2, for tapers B16 and B18

No. 3, for tapers B22 and B24

The length of each of these tapers is, of course, distinctly less than the overall length of the corresponding Morse taper. Each taper may be regarded as corresponding approximately either to that part of the Morse taper nearest the small end (for example: B10), or to the part nearest the large end (for example: B12).

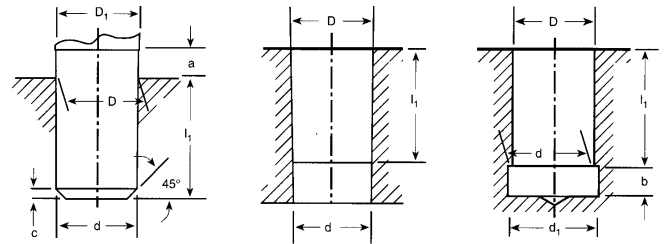

Ref. Diameter No.	D		D1*		d*		d1		l1		a(max.)	
	IN	MM	IN	MM	IN	MM	IN	MM	IN	MM	IN	MM
B10	0.3974	10.094	0.4036	10.3	0.3689	9.4	25/64	9.8	0.571	14.5	0.125	3.5
B12	0.4750	12.065	0.4812	12.2	0.4877	11.1	29/64	11.5	0.728	18.5	0.125	3.5
B16	0.6194	15.733	0.6288	16.0	0.5722	14.5	19/32	15.0	0.945	24.0	0.188	5.0
B18	0.7000	17.780	0.7094	18.0	0.6371	16.2	21/32	16.8	1.260	32.0	0.188	5.0
B22	0.8580	21.793	0.8674	22.0	0.7780	19.8	13/16	20.5	1.594	40.5	0.188	5.0
B24	0.9380	23.825	0.9474	24.1	0.8328	21.3	7/8	22.0	1.988	50.5	0.188	5.0

Ref. Diameter No.	b		c		Morse No.	Taper on	
	IN	MM	IN	MM		IN	MM
B10	0.125	3.5	0.047	1.0	1	0.04988	1.267
B12	0.125	3.5	0.047	1.0	1	0.04988	1.267
B16	0.156	4.0	0.063	1.5	2	0.04995	1.269
B18	0.156	4.0	0.063	1.5	2	0.04995	1.269
B22	0.188	4.5	0.078	2.0	3	0.05020	1.275
B24	0.188	4.5	0.078	2.0	3	0.05020	1.275

NOTES:

* D1 and d = calculated values given for information.

The effective values are obtained by applying the rate of taper and the basic dimension D to the actual values of a and l1, respectively.

Morse Tapers

EXTERNAL TAPER WITH TANG: NOS. 1 TO 6 METRIC

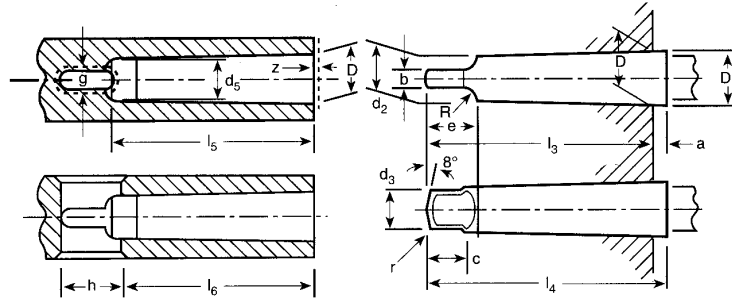

NOTE: All dimensions are in millimeters unless otherwise specified.

Designation		Metric Taper		Morse Taper						Metric Taper				
		4	6	1	2	3	4	5	6	80	100	120	160	200
Basic Size	Taper	1:20=0.05		0.59858:12 =1:20.047 =0.04988	0.59941:12 =1:20.020 =0.04995	0.06235:12 =1:19.922 =0.05020	0.62326:12 =1:19.254 =0.05194	0.63151:12 =1:19.002 =0.05263	0.62565:12 =1:19.180 =0.05214	1:20=0.05				
		EXTERNAL TAPER	D	4	6	12.065	17.78	23.825	31.267	44.399	63.348	80	100	120
a	2		3	3.5	5	5	6.5	6.5	8	8	10	12	16	20
D ₁ (1)	4.1		6.2	12.2	18	24.1	31.6	44.7	63.8	80.4	100.5	120.6	160.8	201
d (1)	2.9		4.4	9.4	14.6	19.8	25.9	37.6	53.9	70.2	88.4	106.6	143	179.4
d ₁ (2)	-		-	M6	M10	M12	M16	M20	M24	M30	M36	M36	M48	M48
d ₃ max.	-		-	8.7	13.5	18.5	24.5	35.7	51	67	85	102	138	174
d ₂ (1)	-		-	9	14	19.1	25.2	36.5	52.4	69	87	105	141	177
d ₄ max.	2.5		4	9	14	19	25	35.7	51	67	85	102	138	174
l ₁ max.	23		32	53.5	64	81	102.5	129.5	182	196	232	268	340	412
l ₂ max.	25		35	57	69	86	109	136	190	204	242	280	356	432
l ₃ max.	-		-	62	75	94	117.5	149.5	210	220	260	300	380	460
l ₄ max.	-		-	65.5	80	99	124	156	218	228	270	312	396	480
b h13	-		-	5.2	6.3	7.9	11.9	15.9	19	26	32	38	50	62
c (3)	-		-	8.5	10	13	16	19	27	24	28	32	40	48
e max.	-		-	13.5	16	20	24	29	40	48	58	68	88	108
l min.	-		-	16	24	28	32	40	50	65	80	80	100	100
R max.	-		-	5	6	7	8	10	13	24	30	36	48	60
R max.	-		-	1.2	1.6	2	2.5	3	4	5	5	6	8	10
t max.	2	3	5	5	7	9	10	16	24	30	36	48	60	
INTERNAL TAPER	d ₅ H11	3	4.6	9.7	14.9	20.2	26.5	38.2	54.6	71.5	90	108.5	145.5	182.5
	d ₆	-	-	7	11.5	14	18	23	27	33	36	39	52	52
	l ₅ min.	25	34	56	67	84	107	135	188	202	240	276	350	424
	l ₆	21	29	52	62	78	98	125	177	186	220	254	321	388
	g A13	22	32	52	63	79	11.9	15.9	19	26	32	38	50	62
	h	8	12	19	22	27	32	33	47	52	60	70	90	110
	z (4)	0.5	0.5	1	1	1	1.5	1.5	2	2	2	2	3	3

NOTES:

1. D₁ and d or d₂ = approximate values given for guidance. The actual values result from the actual values of a and l₁ or l₃ respectively, taking into account the taper and the basic size D.
2. It is allowed to increase the length c over which the tang is turned to diameter d₃, but without exceeding e.
3. z = maximum permissible deviation, outwards of the position of the gauge plane D from the nominal position of coincidence with the leading face.

Morse Tapers

EXTERNAL TAPER WITH TANG: NOS. 1 TO 6

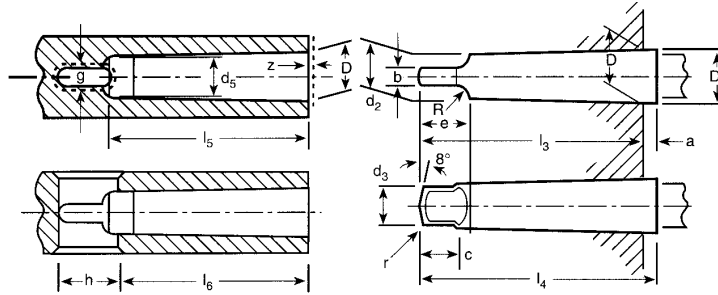

NOTE: All dimensions are in inches unless otherwise specified.

Designation		Morse Taper					
		1	2	3	4	5	6
Basic Size	Taper	0.59858:12 =1:20.047 =0.04988	0.59941:12 =1:20.020 =0.04995	0.06235:12 =1:19.922 =0.05020	0.62326:12 =1:19.254 =0.05194	0.63151:12 =1:19.002 =0.05263	0.62565:12 =1:19.180 =0.05214
	D	0.475	0.700	0.938	1.231	1.748	2.494
EXTERNAL TAPER	a	1/8	3/16	3/16	1/4	1/4	5/16
	D_1 (1)	0.4812	0.7094	0.9474	1.2440	1.7612	2.5103
	d (1)	0.3690	0.5720	0.7780	1.0200	1.4750	2.1160
	d_1 (2)	UNC 1/4	UNC 3/8	UNC 1/2	UNC 5/8	UNC 5/8	UNC 1
	d_2 (1)	0.3534	0.5533	0.7529	0.9908	1.4388	2.0639
	d_3 max.	11/32	17/32	23/32	31/32	1-13/32	2
	d_4 max.	11/32	17/32	23/32	31/32	1-13/32	2
	l_1 max.	2-1/8	2-9/16	3-3/16	4-1/16	5-3/16	7-1/4
	l_2 max.	2-1/4	2-3/4	3-3/8	4-5/16	5-7/16	7-9/16
	l_3 max.	2-7/16	2-15/16	3-11/16	4-5/8	5-7/8	8-1/4
	l_4 max.	2-9/16	3-1/8	3-7/8	4-7/8	6-1/8	8-9/16
	b h12	0.2031	0.2500	0.3125	0.4687	0.6250	0.7500
	c (3)	11/32	13/32	17/32	5/8	3/4	1-1/16
	e max.	0.52	0.66	0.83	0.96	1.15	1.58
	l min.	1/2	3/4	1	1-1/4	1-1/4	2
	R max.	3/16	1/4	9/32	5/16	3/8	1/2
	r max.	3/64	1/16	5/64	3/32	1/8	5/32
t max.	3/16	3/16	1/4	1/4	5/16	3/8	
INTERNAL TAPER	d_5 H11	0.378	0.588	0.797	1.044	1.502	2.150
	d_6	9/32	7/16	9/16	11/16	11/16	1-1/8
	l_5 min.	2-3/16	2-21/32	3-9/32	4-5/32	5-5/16	7-3/8
	l_6	2-1/16	2-1/2	3-1/16	3-7/8	4-15/16	7
	g H12	0.223	0.270	0.333	0.493	0.650	0.780
	h	3/4	7/8	1-1/8	1-1/4	1-1/2	1-7/8
	z (4)	0.040	0.040	0.040	0.060	0.060	0.080

NOTES:

- D_1 and d or d_2 = approximate values given for guidance. The actual values result from the actual values of a and l_1 or l_3 respectively, taking into account the taper and the basic size D .
- It is allowed to increase the length c over which the tang is turned to diameter d_3 , but without exceeding e .
- z = maximum permissible deviation, outwards of the position of the gauge plane D from the nominal position of coincidence with the leading face.

SERVICE AND REPAIR

Mounting and Removing Chucks

ON THREADED SPINDLE PORTABLE TOOLS

TO MOUNT CHUCKS:

Thread chuck on the spindle by hand so that the back of the chuck seats firmly against the mounting surface provided on the portable tool spindle.

TO REMOVE CHUCKS:

Chucks with threaded mounts can be identified by the letters “B” or “BA” in the model number (1B, 41BA). “BA” model chucks may have a left hand thread retaining screw through the chuck body into the tool spindle. Remove retaining screw through the chuck jaw hole opening, turn screw clockwise and proceed as described for “B” model chucks. “B” model chucks may be removed from a threaded spindle by tightening the chuck jaws around a hex key and striking the key with a sharp blow in a counter-clockwise direction, using a wooden or rubber hammer (Illus. A).

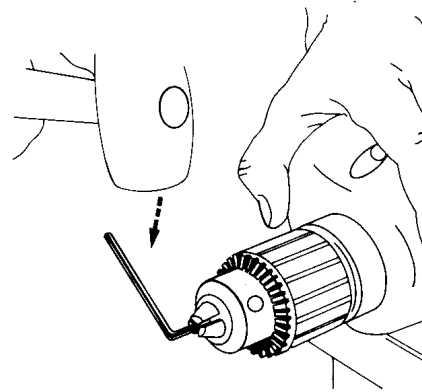

Illus. A

ON TAPERED SPINDLES

TO MOUNT CHUCKS:

Clean both tapers of all grease and grit. With the chuck jaws completely retracted into the chuck and using a thin piece of wood to protect the chuck nose, tap the chuck into place on the spindle.

TO REMOVE CHUCKS:

If a power tool has a tapered spindle, the chuck may be removed from the spindle by inserting chuck removal wedges between the chuck back and the spindle housing (Illus. B).

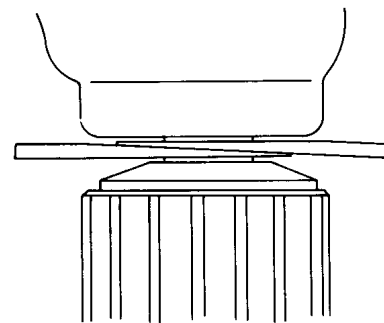

Illus. B

ON TAPERED SHANK ARBORS

TO MOUNT CHUCKS:

Clean both tapers as above. With the jaws retracted into the chuck and with the chuck nose resting on a wooden bench, strike the tang of the arbor lightly to seat it into the chuck. Do NOT assemble on an arbor press as excessive pressure will expand the chuck body and distort the chuck jaw holes.

TO REMOVE CHUCKS:

Insert wedges between the back of the chuck and the shoulder of the arbor (Illus. C). In case the mounting taper of the arbor does not provide a shoulder, a cross hole should be drilled through the neck of the arbor (Illus. D) and a cross pin inserted. Then the wedges can be used between the chuck back and the cross pin. If desired, a hole may be drilled through the soft center portion of the chuck body (Illus. D), and a pin may then be used with an arbor press to force the arbor out of the chuck.

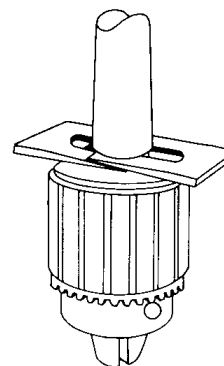

Illus. C

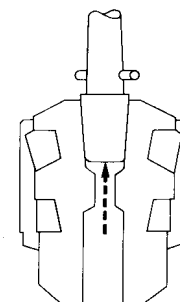

Illus. D

Repair Instructions

DISASSEMBLY

PLAIN BEARING CHUCKS:

Extend the jaws to half capacity, press the sleeve off over front (jaw end) of body, remove the nut halves (Illus. E).

Ball Bearing Chucks:

Extend the jaws to half capacity, press the sleeve off over front (jaw end) of body, remove the nut halves, jaws, bearing race, and thrust washer (Illus. E).

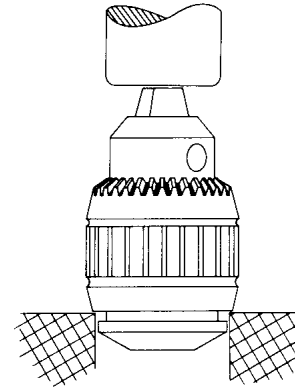

Illus. E

ASSEMBLY

CAUTION: Each of the three jaws differ slightly from the other by the location of the threaded portion (Illus. G). In order to ensure proper operation, they must be re-installed in the proper sequence.

PLAIN BEARING CHUCKS:

Refer to Illus. G and insert the jaws in the correct sequence when viewing the chuck from the body nose diameter. insert No. 1 jaw (with small step) first, then No. 2 jaw (with largest step) in the clockwise position, then No. 3 jaw (without a step) should be inserted.

Turn chuck jaws to closed position and check to ensure that all three jaws are properly aligned. The height of all three jaws should be uniform.

A good grade of grease should be applied to the jaw and nut threads, then the nut halves should be closed around the jaws. Extend jaws to half capacity. Press on the sleeve with an arbor press (Illus. F).

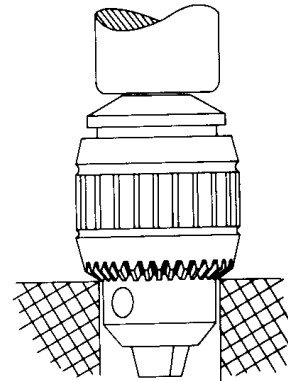

Illus. F

BALL BEARING CHUCKS:

Slip the thrust race over jaw end of the body until it contacts the rear flange. Slip the caged bearing over jaw end of the body until it contacts the thrust race.

Follow Plain Bearing jaw assembly and nut procedure.

**JAW NUMBER INDICATED
BY PROFILES SHOWN BELOW.**

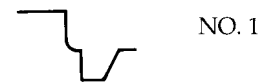

NO. 1

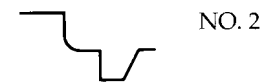

NO. 2

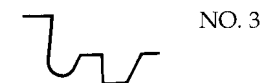

NO. 3

Illus. G - Jaw Identification

DECIMAL EQUIVALENT CHART

Drill Size	Decimal Inches	Drill Size	Decimal Inches	Drill Size	Decimal Inches	Drill Size	Decimal Inches	Drill Size	Decimal Inches	Drill Size	Decimal Inches
0.30mm	0.0118	1.45mm	0.0571	3.30mm	0.1299	5.80mm	0.2283	9.00mm	0.3543	5/8	0.6250
0.32mm	0.0126	1.50mm	0.0591	3.40mm	0.1339	5.90mm	0.2323	T	0.3580	16.00mm	0.6299
80	0.0135	53	0.0595	29	0.1360	A	0.2340	9.10mm	0.3583	16.25mm	0.6398
0.35mm	0.0138	1.55mm	0.0610	3.50mm	0.1378	15/64	0.2344	23/64	0.3594	41/64	0.6406
79	0.0145	1/16	0.0625	28	0.1405	6.00mm	0.2362	9.20mm	0.3622	16.50mm	0.6496
0.38mm	0.0150	1.60mm	0.0630	9/64	0.1406	B	0.2380	9.30mm	0.3661	21/32	0.6562
1/64	0.0156	52	0.0635	3.60mm	0.1411	6.10mm	0.2402	U	0.3680	16.75mm	0.6594
0.40mm	0.0157	1.65mm	0.0650	27	0.1440	C	0.2420	9.40mm	0.3701	17.00mm	0.6693
78	0.0160	1.70mm	0.0669	3.70mm	0.1457	6.20mm	0.2441	9.50mm	0.3740	43/64	0.6719
0.42mm	0.0165	51	0.0670	26	0.1417	D	0.2460	3/8	0.3750	17.25mm	0.6791
0.45mm	0.0177	1.75mm	0.0689	25	0.1495	6.30mm	0.2480	V	0.3770	11/16	0.6875
77	0.0180	50	0.0700	3.80mm	0.1496	1/4, E	0.2500	9.60mm	0.3780	17.50mm	0.6890
0.48mm	0.0189	1.80mm	0.0709	24	0.1520	6.40mm	0.2520	9.70mm	0.3819	45/64	0.7031
0.50mm	0.0197	1.85mm	0.0728	3.90mm	0.1535	6.50mm	0.2559	9.80mm	0.3858	18.00mm	0.7087
76	0.0200	49	0.0730	23	0.1540	F	0.2570	W	0.3860	23/32	0.7188
75	0.0210	1.90mm	0.0748	5/32	0.1562	6.60mm	0.2598	9.90mm	0.3898	18.50mm	0.7283
0.55mm	0.0211	48	0.0760	22	0.1570	G	0.2610	25/64	0.3906	47/84	0.7344
74	0.0225	1.95mm	0.0768	4.00mm	0.1575	6.70mm	0.2638	10.00mm	0.3937	19.00mm	0.7480
0.60mm	0.0236	5/64	0.0781	21	0.1590	17/64	0.2656	X	0.3970	3/4	0.7500
73	0.0240	47	0.0785	20	0.1610	H	0.2660	10.20mm	0.4016	49/64	0.7656
0.62mm	0.0244	2.00mm	0.0787	4.10mm	0.1614	6.80mm	0.2677	Y	0.4040	19.50mm	0.7677
72	0.0250	2.05mm	0.0807	4.20mm	0.1654	6.90mm	0.2717	13/32	0.4062	25/32	0.7812
0.65mm	0.0256	46	0.0810	19	0.1660	I	0.2720	Z	0.4130	20.00mm	0.7874
71	0.0260	45	0.0820	4.30mm	0.1693	7.00mm	0.2756	10.50mm	0.4134	51/64	0.7969
0.70mm	0.0276	2.10mm	0.0827	18	0.1695	J	0.2770	27/64	0.4219	20.50mm	0.8071
70	0.0280	2.15mm	0.0846	11/64	0.1719	7.10mm	0.2795	10.80mm	0.4252	13/16	0.8125
69	0.0292	44	0.0860	17	0.1730	K	0.2810	11.00mm	0.4331	21.00mm	0.8268
0.75mm	0.0295	2.20mm	0.0866	4.40mm	0.1732	9/32	0.2812	7/16	0.4375	53/64	0.8281
68	0.0310	2.25mm	0.0886	16	0.1770	7.20mm	0.2835	11.20mm	0.4409	27/32	0.8438
1/32	0.0312	43	0.0890	4.50mm	0.1772	7.30mm	0.2874	11.50mm	0.4528	21.50mm	0.8465
0.80mm	0.0315	2.30mm	0.0906	15	0.1800	L	0.2900	29/64	0.4531	55/64	0.8594
67	0.0320	2.35mm	0.0925	4.60mm	0.1811	7.40mm	0.2913	11.80mm	0.4646	22.00mm	0.8661
66	0.0330	42	0.0935	14	0.1820	M	0.2950	15/32	0.4688	7/8	0.8750
0.85mm	0.0335	3/32	0.0938	4.70 13	0.1850	7.50mm	0.2953	12.00mm	0.4724	22.50mm	0.8858
65	0.0350	2.40mm	0.0945	3/16	0.1875	19/64	0.2969	12.20mm	0.4803	57/64	0.8906
0.90mm	0.0354	41	0.0960	4.80 12	0.1890	7.60mm	0.2992	31/64	0.4844	23.00mm	0.9055
64	0.0360	2.45mm	0.0965	11	0.1910	N	0.3020	12.50mm	0.4921	29/32	0.9062
63	0.0370	40	0.0980	4.90mm	0.1929	7.70mm	0.3031	1/2	0.5000	59/64	0.9219
0.95mm	0.0374	2.50mm	0.0984	10	0.1935	7.80mm	0.3071	12.80mm	0.5039	23.50mm	0.9252
62	0.0380	39	0.0995	9	0.1960	7.90mm	0.3110	13.00mm	0.5118	15/16	0.9375
61	0.0390	38	0.1015	5.00mm	0.1969	5/16	0.3125	33/64	0.5156	24.00mm	0.9449
1.00mm	0.0394	2.60mm	0.1024	8	0.1990	8.00mm	0.3150	13.20mm	0.5197	61/64	0.9531
60	0.0400	37	0.1040	5.10mm	0.2008	O	0.3160	17/32	0.5312	24.50mm	0.9646
59	0.0410	2.70mm	0.1063	7	0.2010	8.10mm	0.3189	13.50mm	0.5315	31/32	0.9688
1.05mm	0.0413	36	0.1065	13/64	0.2031	8.20mm	0.3228	13.80mm	0.5433	25.00mm	0.9843
58	0.0420	7/64	0.1094	6	0.204	P	0.3230	36/64	0.5469	63/64	0.9844
57	0.0430	35	0.1100	5.20mm	0.2047	8.30mm	0.3268	14.00mm	0.5512	1"	1.0000
1.10mm	0.0433	2.80mm	0.1102	5	0.2055	21/64	0.3281	14.25mm	0.5610		
1.15mm	0.0453	34	0.1110	5.30mm	0.2087	8.40mm	0.3307	9/16	0.5625		
56	0.0465	33	0.1130	4	0.2090	Q	0.3320	14.50mm	0.5709		
3/64	0.0469	2.90mm	0.1142	5.40mm	0.2126	8.50mm	0.3346	37/64	0.5781		
1.20mm	0.0472	32	0.1160	3	0.2130	8.60mm	0.3386	14.75mm	0.5807		
1.25mm	0.0492	3.00mm	0.1181	5.50mm	0.2165	R	0.3390	15.00mm	0.5906		
1.30mm	0.0512	31	0.1200	7/32	0.2188	8.70mm	0.3425	19/32	0.5938		
55	0.0520	3.10mm	0.1220	5.60mm	0.2205	11/32	0.3438	15.25mm	0.6004		
1.35mm	0.0531	1/8	0.1250	2	0.2210	8.80mm	0.3465	39/64	0.6094		
54	0.0550	3.20mm	0.1260	5.70mm	0.2244	S	0.3480	15.50mm	0.6102		
1.40mm	0.0551	30	0.1285	1	0.2280	8.90mm	0.3504	15.75mm	0.6201		